



ALTERNATOR & GENERATOR COMPONENTS

PART 2
16th Edition

ISO 9001
BUREAU VERITAS
Certification



Contents

Page	Page
Bosch alternator parts 3	Romanian alternator parts 687
Bosch generator parts 166	Sawafuji alternator parts 688
Briggs & Stratton alternator parts 170	SEV alternator parts 692
Butec alternator parts 171	Tecumseh alternator parts 698
CAV alternator parts 174	Valeo Korea alternator parts 699
Chrysler alternator parts 186	Valeo / Paris Rhone alternator parts 702
Delco Eur. alternator parts 194	Valeo / Paris Rhone generator parts 769
Delco Korea alternator parts 208	Wapsa alternator parts 770
Delco US alternator parts 214	Trucks / Coaches 771
Ducellier alternator parts 273	Miscellaneous 772
Ducellier generator parts 284	Dynastarter components 778
Elmot alternator parts 285	Universal components 780
Femsa alternator parts 288	Terminal Chart 791
Ford US alternator parts 292	Assortments 793
Ford US generator parts 320	Assortment Box and Inserts 795
Ford / Visteon alternator parts 321	Index for Assortments 804
Hitachi alternator parts 325	Pulley Survey & Mounting bushing survey 809
Iskra alternator parts 387	Bearings 821
Lada alternator parts 397	Needle Bearings 838
Leece Neville alternator parts 402	Roller Bearings 848
Lucas alternator parts 412	Bearing Survey 851
Lucas generator parts 436	Multi-Purpose Grease 853
Magneti Marelli alternator parts 440	O-ring Survey 854
Magneti Marelli generator parts 480	Washer Survey 855
Magneton alternator parts 481	Oil seal Survey 856
Mando Melroe alternator parts 490	
Mitsubishi alternator parts 502	
Motorola Eur. alternator parts 578	
Motorola US alternator parts 589	
Nikko alternator parts 603	
Nippondenso alternator parts 610	
Poong Sung alternator parts 679	
Prestolite alternator parts 682	

ABBREVIATIONS:

A=Assortment, **AC**=Air Condition, **Amp.**=Ampere, **AT**=Automatic Transmission, **Ca**=Catalyzer, **CW**=Clockwise rotation, **Eng.**=Engine, **Eur.**=European application, **HD**=Heavy Duty construction, **Ht.**=Height, **I.D.**=Inner Diameter, **KW.**=Kilowatt, **L.**=Length, **LHD**=Left Hand Drive, **LL.**=Lead Lenght, **LRC**=Low responce control, **M**=Minimum supply, **O.D.**=Outer Diameter, **Th.**=Thickness, **V.**=Volt, **W**=With, **W/o**=Without, **W.**=Width,  = New in catalogue

Care is taken to ensure the accuracy of descriptions and applications of each item, but  assumes no responsibility for possible errors. O.E.M. names and numbers are used for reference purposes only.

Printed in Denmark. Copyright © 2007 Holger Christiansen A/S

Replacing BOSCH

Rotors



130080

Replacing 1124 033 011, -015
Servicing 0120 300 518, -519, -523, -529, -530, -531, -533, -536, -537, -539, -540, -545, -546, -547, -548, -552, -562, -564, -575, -577, -578, -584, -585, -586, -588, -589, -590, 0120 339 511, 9120 143 001, -002, -003, -007, -009, -011, -021, -023, 12 V. 28 Amp.
 L. 147 mm, O.D. 73 mm, Shaft 17 mm

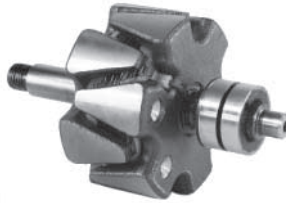

130085

Replacing 1124 034 115, -049
Servicing 0120 400 722, -723, -743, -747, -782, -783, -834, -852, -853, -912, -913, 0120 489 022, -507, -526, -527, -556, -627, -683, -743, -786, -828, -878, 9120 144 238 12 V. 55 Amp.
 L. 154 mm, O.D. 89 mm, Shaft 17 mm



130089

Replacing 1124 034 080
Servicing 0120 400 836, -837, -863 12 V. 50 Amp.
 L. 260 mm, O.D. 89 mm, Shaft 17 mm



130083

Replacing 1124 034 214
Servicing 0120 489 500, -513, -514, -519, -532, -546, -548, -557, -558, -559, -572, -581, -623, -652, -676, -678, -699, -745, -800 12 V. 45 Amp.
 L. 148.2 mm, O.D. 89 mm, Shaft 17 mm

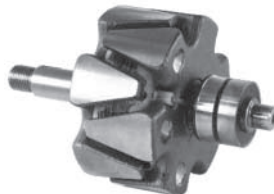

130087

Replacing 1124 034 051
Servicing 0120 400 720, -887, -905, 9120 144 006, -007, -008 24 V. 35 Amp.
 L. 147 mm, O.D. 89 mm, Shaft 17 mm



130091

Replacing 1124 034 213
Servicing 0120 489 565, -566, -584 12 V. 55 Amp.
 L. 260 mm, O.D. 89 mm, Shaft 17 mm

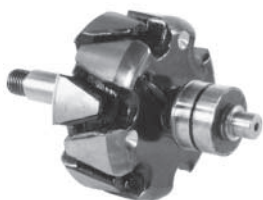

130084

Replacing 1124 034 035
Servicing 0120 400 670, -724, -740, -741, -832, -854, -855, -857, -910, -911, 9120 144 249, -253 12 V. 35 Amp.
 L. 145 mm, O.D. 89 mm, Shaft 17 mm



130088

Replacing 1124 034 077, -546
Servicing 0120 400 830, -843 24 V. 27 Amp.
 L. 152 mm, O.D. 89 mm, Shaft 17 mm

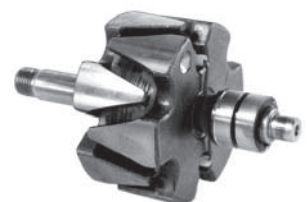

130092

Replacing 1124 034 119
Servicing 0120 489 192, -702 24 V. 35 Amp.
 L. 157 mm, O.D. 89 mm, Shaft 17 mm
Shaft: Cargo 133799

Replacing BOSCH



131073

Replacing 1124 034 169
Servicing 0120 489 060, -303, -643, 9120 144 112, -113, -115, -116, -117, -119
 24 V. 45 Amp.
 L. 157 mm, O.D. 89 mm, Shaft 17 mm
Shaft: Cargo 133799



131633

Replacing 1124 034 015
Servicing 0120 400 642, -666, -694, -699, -774, -791, -805, -826, -884, -891
 24 V. 21/27 Amp.
 L. 140 mm, O.D. 89 mm, Shaft 17 mm

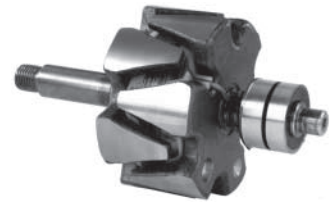

131636

Replacing 1124 034 071
Servicing 0120 400 796, -797, -842, -877
 24 V. 35 Amp.
 L. 168 mm, O.D. 89 mm, Shaft 17 mm



131128

Replacing 1124 034 206
Servicing 0120 489 615, -619, -621, -660, -688, -712, -716, -718, -758, -781, -857, -867, -869
 12 V. 65 Amp.
 L. 152 mm, O.D. 89 mm, Shaft 17 mm



131634

Replacing 1124 034 045
Servicing 0120 400 708, -784
 24 V. 35 Amp.
 L. 146 mm, O.D. 89 mm, Shaft 17 mm

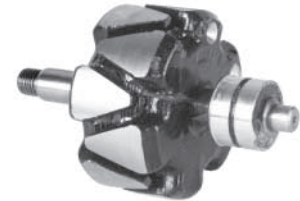

131637

Replacing 1124 034 264
Servicing 0120 489 047, -139, -624, -669, -706, -833, -842, -847, -848, -896
 12 V. 45 Amp.
 L. 154 mm, O.D. 89 mm, Shaft 17 mm



131497

Replacing 1124 034 120
Servicing 0120 489 053, -230, -684
 24 V. 35 Amp.
 L. 166 mm, O.D. 89 mm, Shaft 17 mm



131635

Replacing 1124 034 212
Servicing 0120 489 521, -523, -535, -545, -560, -600, -622, -650, -654, -659, -679, -686, -735, -747, -755
 12 V. 55 Amp.
 L. 152 mm, O.D. 89 mm, Shaft 17 mm



131639

Replacing 1124 034 265, -633, -811
Servicing 0120 489 051, -052, -054, -075, -593, -595, -667, -671, -801, -811, -843, -844, -850, -851, -856, -856
 12 V. 55 Amp.
 L. 140 mm, O.D. 89 mm, Shaft 17 mm

Replacing BOSCH

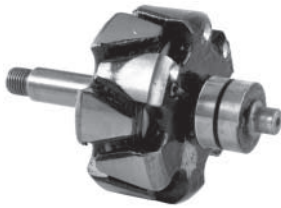

131640

Replacing 1124 034 025
Servicing 0120 400 639, -645, -700, -729, -736, -788, -874, -904
 12 V. 55 Amp.
 L. 141 mm, O.D. 89 mm, Shaft 17 mm



131938

Replacing 1124 034 243
Servicing 0120 489 061, -066, -070, -135, -141, -146, -147, -151, -170, -183, -188, -215, -217, -218, -285, -286, -294, -297
 12 V. 55 Amp.
 L. 154 mm, O.D. 89 mm, Shaft 17 mm

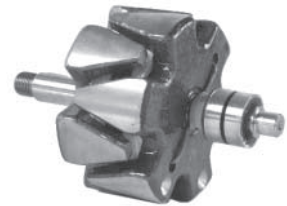

131946

Replacing 1124 035 069
Servicing 0120 450 004, 0120 469 501, -503, -504, -535, -528, -505
 12 V. 90 Amp.
 L. 161 mm, O.D. 100 mm, Shaft 17 mm



131849

Replacing 1124 035 073
Servicing 0120 469 525, -539, -542, -543, -544, -561, -576, -593, -819
 12 V. 90 Amp.
 L. 161 mm, O.D. 100 mm, Shaft 17 mm



131940

Replacing 1124 034 171
Servicing 0120 489 793, -794, -795, -796
 24 V. 27 Amp.
 L. 149 mm, O.D. 89 mm, Shaft 17 mm



131947

Replacing 1124 035 061, -110, -157, -162
Servicing 0120 469 581, -586, -610, -786, -787, -793, -862, -882, -885, -886, -887, -915, -916, -949, -950, -992, -993, -996
 12 V. 90 Amp.
 L. 156 mm, O.D. 100 mm, Shaft 17 mm



131937

Replacing 1124 034 221
Servicing 0120 489 544, -607, -608, -610, -783
 12 V. 55 Amp.
 L. 140 mm, O.D. 89 mm, Shaft 17 mm



131945

Replacing 1124 034 266
Servicing 0120 489 509, -511, -522, -536, -551, -562, -568, -601, -603, -616, -665, -938
 12 V. 45 Amp.
 L. 144 mm, O.D. 89 mm, Shaft 17 mm



131948

Replacing 1124 034 167
Servicing 0120 400 945, 0120 489 004, -005, -017, -063, -081, -186, -197, -207, -211, -249, -282, -283, -365, -366, -370, -371, -375, -379, -381, -386, -425, -430, -431, -435, -438, -441, -445, -448, -449
 12 V. 65 Amp.
 L. 152 mm, O.D. 89 mm, Shaft 17 mm

Replacing BOSCH



131949

Replacing 1124 034 185
Servicing 0120 489 008, -009, -083, -228, -229, -236, -237, -239, -261, -363, -383, -428, -437, -447, -970
 12 V. 55 Amp.
 L. 152 mm, O.D. 89 mm, Shaft 17 mm



131956

Replacing 1124 034 208, -239
Servicing 0120 489 010, -011, -039, -042, -044, -094, -095, -100, -111, -119, -148, -174, -182, -213, -214, -245, -252, -266, -267, -287, -288, -289, -290, -291, -292
 12 V. 55 Amp.
 L. 152 mm, O.D. 89 mm, Shaft 17 mm



132338

Replacing 1124 033 022
Servicing 0120 300 550, -551, -568, -569, -592, 0120 339 516, -523, -528, -534, 9120 143 015, -017, -024, -034, -204, -218
 12 V. 33 Amp.
 L. 155 mm, O.D. 73 mm, Shaft 17 mm



131950

Replacing 1124 034 165
Servicing 0120 489 613, -614, -713, -714, -772, -774, -785, -870, -871, -873
 12 V. 65 Amp.
 L. 151 mm, O.D. 89 mm, Shaft 17 mm



131957

Replacing 1124 034 246, -354, -668
Servicing 0120 488 144, -145, 0120 489 024, -064, -129, -131, -137, -143, -149, -150, -153, -154, -155, -168, -171, -212, -219, -220, -243, -254, -275
 12 V. 65 Amp.
 L. 154 mm, O.D. 89 mm, Shaft 17 mm



132340

Replacing 1124 033 024
Servicing 0120 339 512, -513, -514, -521, -531, -532, -535, -536, -542, -545, 9120 143 222, -223
 12 V. 33 Amp.
 L. 147 mm, O.D. 73 mm, Shaft 17 mm

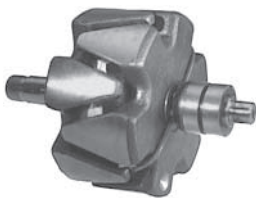

131951

Replacing 1124 035 072
Servicing 0120 469 572, -574, -595, -618, -619, -656, -657, -658, -664, -668, -681, -751, -758, -759, -781, -830
 12 V. 70 Amp.
 L. 156 mm, O.D. 100 mm, Shaft 17 mm



131958

Replacing 1124 034 155
Servicing 0120 489 022, -704, -710, -725, -902, -994, -995, -996
 12 V. 55 Amp.
 L. 156 mm, O.D. 89 mm, Shaft 17 mm



132341

Replacing 1124 034 028
Servicing 0120 400 640, -689, -732, -790
 24 V. 17 Amp.
 L. 138 mm, O.D. 89 mm, Shaft 17 mm

Replacing BOSCH



132342

Replacing 1124 034 052
Servicing 0120 400 713, -929,
 9120 080 031, -083
 12 V. 55 Amp.
 L. 157 mm, O.D. 89 mm, Shaft 17 mm

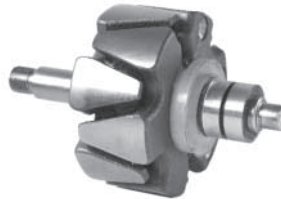

132348

Replacing 1124 034 175
Servicing 0120 489 023, -033, -034, -035,
 -055, -728, -730, -886
 24 V. 27 Amp.
 L. 148 mm, O.D. 89 mm, Shaft 17 mm
Shaft: Cargo 133800



132850

Replacing 9121 144 005, -019
Servicing 0120 488 000, -001, -002, -003,
 -009
 12 V. 65 Amp. 18 Splines
 L. 200 mm, O.D. 89 mm, Shaft 17 mm
Shaft: Cargo 133435



132343

Replacing 1124 034 063
Servicing 0120 400 773, -799, -846, -888
 24 V. 27 Amp.
 L. 152 mm, O.D. 89 mm, Shaft 17 mm



132349

Replacing 1124 034 176
Servicing 0120 489 224, -320, -731, -827,
 -944
 24 V. 35 Amp.
 L. 165 mm, O.D. 89 mm, Shaft 17 mm



133188

Replacing 1124 035 024, -058
Servicing 0120 469 518, -527, -562, -761
 24 V. 55 Amp.
 L. 175 mm, O.D. 100 mm, Shaft 17 mm
Shaft: Cargo 133801



132347

Replacing 1124 034 172
Servicing 0120 489 388, -707, -727, -733
 24 V. 27 Amp.
 L. 148 mm, O.D. 89 mm, Shaft 17 mm
Shaft: Cargo 133800



132350

Replacing 1124 034 182
Servicing 0120 489 013, -062, -199, -201,
 -205, -209, -247, -250, -368, -373, -377,
 -380, -433, -440, -442, -444, -496, -961,
 -967, -987
 12 V. 45 Amp.
 L. 152 mm, O.D. 89 mm, Shaft 17 mm



133444

Replacing 1124 035 077
Servicing 0120 469 686
 24 V. 55 Amp.
 L. 172 mm, O.D. 100 mm, Shaft 17 mm
Shaft: Cargo 135329

Replacing BOSCH



133559

Replacing 1124 035 057, -177
Servicing 0120 469 523, -549, -569, -634, -673, -679, -693, -763, -798, -807
 24 V. 55 Amp.
 L. 161 mm, O.D. 100 mm, Shaft 17 mm



134097

Replacing 1124 034 311
Servicing 0120 489 332, -333
 12 V. 55 Amp.
 L. 149 mm, O.D. 89 mm, Shaft 17 mm
Shaft: Cargo 133910



134829

Replacing 1124 034 188, -207
Servicing 0120 489 991
 12 V. 45 Amp.
 L. 160 mm, O.D. 89 mm, Shaft 17 mm

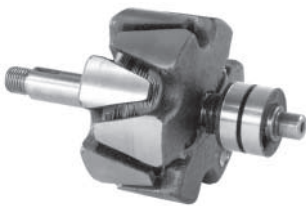

134045

Replacing 1124 034 152, -232
Servicing 0120 489 818, -819, -915, -916
 12 V. 45 Amp.
 L. 160 mm, O.D. 89 mm, Shaft 17 mm



134710

Replacing 1124 034 258
Servicing 0120 489 316
 24 V. 30 Amp.
 L. 165 mm, O.D. 89 mm, Shaft 17 mm

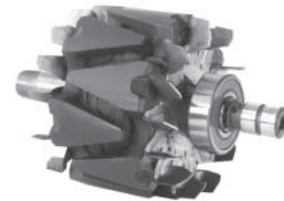

134912 OE

Replacing 1124 034 410
Servicing 0120 485 015
 12 V. 80 Amp.
 L. 150 mm, O.D. 94 mm, Shaft 17 mm



134046

Replacing 1124 034 308
Servicing 0120 489 323, -324
 12 V. 55 Amp.
 L. 149 mm, O.D. 89 mm, Shaft 17 mm



134732

Replacing 1124 037 000
Servicing 0120 689 503, -504, -505, -506, -507, -508, -510, -512, -514, -515, -516, -524, -525
 24 V. 95 Amp.
 L. 248 mm, O.D. 125 mm, Shaft 30 mm



135087

Replacing 1124 034 248, -313
Servicing 0120 488 129, -214, -215
 12 V. 55 Amp.
 L. 147 mm, O.D. 89 mm, Shaft 17 mm

Replacing BOSCH



135088

Replacing 1124 034 241
Servicing 0120 489 123, -124, -618
 12 V. 55 Amp.
 L. 148.5 mm, O.D. 89 mm, Shaft 17 mm



135996

Replacing 1124 037 001
Servicing 0120 689 511, -513, -517, -518, -538, -539, -550
 24 V. 120 Amp.
 L. 248 mm, O.D. 125 mm, Shaft 30 mm



136286

Replacing 9121 144 037, 9122 334 021
Servicing 6033 GB4 009, 9120 144 605, -606, -608, -609, -617, -618, -638, -641
 12 V. 55 Amp. 18 Splines
 L. 210 mm, O.D. 89 mm, Shaft 17 mm
Shaft: Cargo 137223



135868

Replacing 1124 035 120, -131, -211, -212
Servicing 0120 469 920, -959, -960
 24 V. 55 Amp.
 L. 164 mm, O.D. 100 mm, Shaft 17 mm



135997

Replacing 1124 037 002
Servicing 0120 689 520, -522, -526, -528, -531, -533, -534, -540, -543, -545
 24 V. 120 Amp.
 L. 248 mm, O.D. 125 mm, Shaft 30 mm



136385

Replacing 1124 035 007, -054, -165
Servicing 0120 469 509
 24 V. 55 Amp.
 L. 173 mm, O.D. 100 mm, Shaft 17 mm



135872

Replacing 1124 034 347, -650, -653
Servicing 0120 484 002, -003, -004, -005, -006, -010, -014, -016, -020
 12 V. 85 Amp.
 L. 154 mm, O.D. 94 mm, Shaft 17 mm

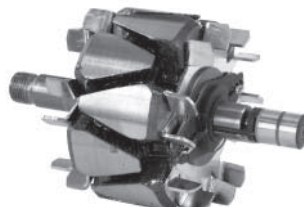

136050

Replacing 1124 034 421, -434, -488, -936
Servicing 0120 485 034, -043, -044, -046, 0123 114 005, 0123 310 001, -002, -003, -007, 0123 315 001, -002, -006
 12 V. 70 Amp.
 L. 154 mm, O.D. 94 mm, Shaft 17 mm

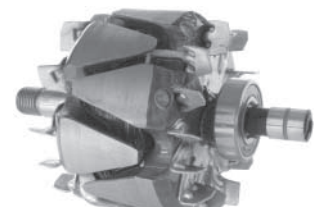

136387

Replacing 1124 035 483, -504, -512
Servicing 0120 465 003, -004, -013, -014, -015, -016, -017, 0123 500 001, 0123 510 002, -012, -022, -023, -038, -039
 12 V. 120 Amp.
 L. 159 mm, O.D. 103 mm, Shaft 17 mm

Replacing BOSCH

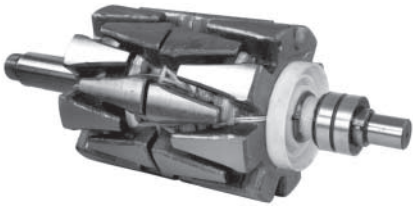

136462

Replacing 2124 037 063, -065
Servicing 0120 689 519, -529, -536, -537, -544, -547, -554, -556, -560
 24 V. 180 Amp.
 L. 346.5 mm, O.D. 125 mm, Shaft 30 mm



136579

Replacing 1124 037 004
Servicing 0120 689 527, -530, -535, -541, -546, -548, -549
 24 V. 140 Amp.
 L. 248 mm, O.D. 125 mm, Shaft 30 mm



136824

Replacing 1124 035 134, -225
Servicing 0120 468 080, -081, -084, -085, -086
 12 V. 100 Amp.
 L. 165.7 mm, O.D. 103 mm, Shaft 17 mm



136466

Replacing 1124 033 101, -110, -119
Servicing 0120 335 008, 0123 115 010, -011
 12 V. 70 Amp.
 L. 148 mm, O.D. 89 mm, Shaft 17 mm

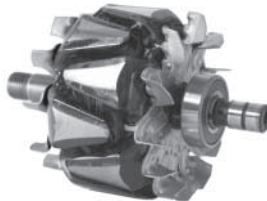

136800

Replacing 1124 035 450, -455
Servicing 0123 500 007, -008, -009, 0123 505 002, -003
 12 V. 90 Amp.
 L. 156 mm, O.D. 103 mm, Shaft 17 mm

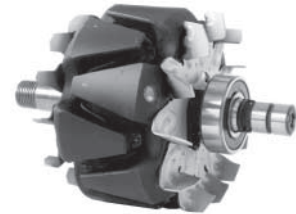

136828

Replacing 1124 035 407, -414, -434, -456
Servicing 0123 505 001, -004, 0123 510 020
 12 V. 120 Amp.
 L. 156 mm, O.D. 104 mm, Shaft 17 mm



136479

Replacing 1124 034 437, -961
Servicing 0123 310 014, -015
 12 V. 70 Amp.
 L. 146 mm, O.D. 93 mm, Shaft 17 mm



136819 OE

Replacing 1124 033 103
Servicing 0120 335 006, -011
 12 V. 50 Amp.
 L. 142 mm, O.D. 90 mm, Shaft 17 mm



136829

Replacing 1124 035 226
Servicing 0120 468 053, -107, -113, -118
 24 V. 80 Amp.
 L. 170 mm, O.D. 103 mm, Shaft 17 mm

Replacing BOSCH



136835

Replacing 1124 034 427, -457
Servicing 0120 485 025, -026,
 0123 310 004, 0123 320 004, -010,
 0123 335 002, -003, 0123 345 004
 12 V. 90 Amp.
 L. 153 mm, O.D. 93.3 mm, Shaft 17 mm



136853

Replacing 1124 034 257, -642
Servicing 0120 489 315
 12 V. 55 Amp.
 L. 165 mm, O.D. 89 mm, Shaft 17 mm



137067

Replacing 1124 035 094, -197, -199, -208
Servicing 0120 468 009, -010, -015, -016, -
 019, -020, -023, -024, -042, -043, -044,
 -056, -070, -108, -121, -122, -123
 12 V. 110 Amp.
 L. 161 mm, O.D. 103 mm, Shaft 17 mm



136839

Replacing 1124 034 660
Servicing 0120 484 017, -019
 12 V. 120 Amp.
 L. 154 mm, O.D. 94 mm, Shaft 17 mm



136972

Replacing 1124 034 048, -727
Servicing 0120 400 721, -894
 12 V. 55 Amp.
 L. 144 mm, O.D. 89 mm, Shaft 17 mm



137236

Replacing 1124 034 415, -450, -499
Servicing 0120 485 048, 0123 310 022
 12 V. 70 Amp.
 L. 164 mm, O.D. 94 mm, Shaft 17 mm



136847

Replacing 1124 034 276, -364, -583
Servicing 0120 488 112, -139, -152,
 -201, 0120 489 424, -472
 12 V. 70 Amp.
 L. 154 mm, O.D. 89 mm, Shaft 17 mm



136993

Replacing 1124 034 350, -678
Servicing 0120 488 153, -269, -270
 24 V. 35 Amp.
 L. 154 mm, O.D. 89 mm, Shaft 17 mm



137237

Replacing 1124 035 123, -201
Servicing 0120 468 061, -062, -063, -064,
 -075, -076, -077, -078, -103, -104, -105,
 -110, -111
 12 V. 140 Amp.
 L. 164 mm, O.D. 104 mm, Shaft 17 mm

Replacing BOSCH



137238

Replacing 1124 035 229
Servicing 0120 468 093
 24 V. 80 Amp.
 L. 164 mm, O.D. 103 mm, Shaft 17 mm

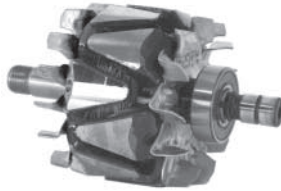

137331

Replacing 1124 034 452, -467, -929
Servicing 0123 310 026, 0123 320 020,
 -022, -023, -029, 0123 335 006, -008
 12 V. 90 Amp.
 L. 153 mm, O.D. 93.5 mm, Shaft 17 mm



137511

Replacing 1124 035 400, -416, -438, -475
Servicing 0120 465 006, -008, -009,
 -010, -011, -012, -018, -020, -021, -023,
 -026, -027, -028, -029, 0123 213 005
 12 V. 120 Amp.
 L. 165 mm, O.D. 103 mm, Shaft 17 mm



137239

Replacing 1124 035 217, -239
Servicing 0120 468 029, -101, -125
 12 V. 115 Amp.
 L. 254 mm, O.D. 103 mm, Shaft 17 mm



137506

Replacing 1124 034 447, -474, -962
Servicing 0123 310 033, -050, -051,
 0123 320 014
 12 V. 90 Amp.
 L. 150 mm, O.D. 93 mm, Shaft 17 mm

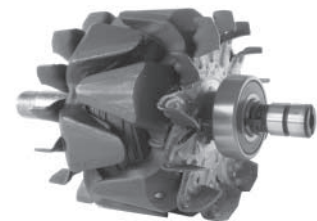

137512

Replacing 1124 035 477, -478, -508, -516
Servicing 0120 465 031, 0123 214 002,
 0123 515 002, -007, -010
 12 V. 140 Amp.
 L. 170 mm, O.D. 103 mm, Shaft 17 mm



137241

Replacing 1124 035 433, -454, -526
Servicing 0123 212 001
 12 V. 90 Amp.
 L. 149 mm, O.D. 103.5 mm, Shaft 17 mm



137510

Replacing 1124 034 463, -476, -964
Servicing 0123 310 023, -048
 12 V. 70 Amp.
 L. 145 mm, O.D. 93 mm, Shaft 17 mm



137642

Replacing 9122 334 020
Servicing 9120 335 000, -001
 12 V. 90 Amp. 18 Splines
 L. 207.8 mm, O.D. 100 mm, Shaft 17 mm

Replacing BOSCH



137722

Replacing 9122 334 030
Servicing 0120 469 103
 24 V. 55 Amp.
 L. 169 mm, O.D. 100 mm, Shaft 17 mm



138036

Replacing 1124 034 429
Servicing 0123 325 002, -003,
 0123 510 003
 12 V. 80 Amp.
 L. 146 mm, O.D. 93 mm, Shaft 17 mm



138041

Replacing 1124 034 574, -765
Servicing 0120 489 232, -233, -234, -300,
 -301, -302
 12 V. 55 Amp.
 L. 154 mm, O.D. 89 mm, Shaft 17 mm



137787

Replacing 1124 034 403, -414, -444, -477
Servicing 0120 485 012, -022,
 0123 310 005, -010, -011, 0123 315 005
 12 V. 80 Amp.
 L. 153 mm, O.D. 93 mm, Shaft 17 mm



138038

Replacing 1124 034 453, -937
Servicing 0123 310 018, -024, -025, -031,
 -032, -034, -035, -037, -038, -039, -040,
 -046, -049
 12 V. 70 Amp.
 L. 158 mm, O.D. 93 mm, Shaft 17 mm



138043

Replacing 1124 035 100, -150
Servicing 0120 468 007, -008, -013, -014,
 -050, -051, -067, -073, -074, -095, -096,
 -097, -098
 12 V. 140 Amp.
 L. 166 mm, O.D. 103 mm, Shaft 17 mm



138035

Replacing 1124 033 121
Servicing 0123 110 005, 0123 120 001
 12 V. 70 Amp.
 L. 148 mm, O.D. 89 mm, Shaft 17 mm



138039

Replacing 1124 034 913, -934, -946
Servicing 0123 310 017, -030,
 0123 320 006, -009, -019, -021, -025, -027,
 -031, -032, -033, -034, -038, -055, -059
 12 V. 90 Amp.
 L. 158 mm, O.D. 93 mm, Shaft 17 mm



138044

Replacing 1124 035 142, -146, -216
Servicing 0120 468 032, -033, -071, -072
 12 V. 140 Amp.
 L. 169 mm, O.D. 103 mm, Shaft 17 mm

Replacing BOSCH



138045

Replacing 1124 035 242
Servicing 0120 468 131, -132, 6033 GB3 033, -034, -035, -036
 24 V. 65 Amp.
 L. 177.5 mm, O.D. 103 mm, Shaft 17 mm



138200

Replacing 1124 034 249, -566, -760
Servicing 0120 489 225, -231, -284
 24 V. 27 Amp.
 L. 154 mm, O.D. 89 mm, Shaft 17 mm

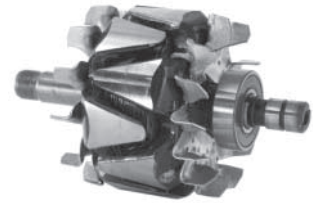

138235

Replacing 1124 034 480
Servicing 0123 315 016, -021
 12 V. 80 Amp.
 L. 158 mm, O.D. 93 mm, Shaft 17 mm



138048

Replacing 1124 035 511
Servicing 0123 510 004, -018, -021, -060, -074, -075
 12 V. 143 Amp.
 L. 159.5 mm, O.D. 111 mm, Shaft 17 mm



138227

Replacing 1124 034 677
Servicing 0120 488 206, -234, -252, -253, -266, -283, -288, -294, 6033 G20 04B
 24 V. 35/45 Amp.
 L. 154 mm, O.D. 89 mm, Shaft 17 mm



138250

Replacing 1124 033 131
Servicing 0123 110 007
 12 V. 65 Amp.
 L. 144 mm, O.D. 89 mm, Shaft 17 mm



138177

Replacing 1124 035 447, -531, -536, -538
Servicing 0123 520 002, -005, -014, 0123 525 001
 12 V. 150 Amp.
 L. 163.9 mm, O.D. 111.5 mm, Shaft 17 mm



138228

Replacing 1124 035 133, -193
Servicing 0120 450 023, -025, -026, -027, -028, -029, -030, -031
 12 V. 90/120 Amp.
 L. 150 mm, O.D. 100 mm, Shaft 17 mm



138251

Replacing 1124 034 652
Servicing 0120 484 011, -018, -026
 12 V. 95 Amp.
 L. 154 mm, O.D. 93 mm, Shaft 17 mm

Replacing BOSCH



138263

Replacing 1124 035 135, -136, -202, -203
Servicing 0120 469 005, -907, -912, -967, -969, -974, -985
 12 V. 80/105 Amp.
 L. 159 mm, O.D. 100 mm, Shaft 17 mm



138521

Replacing 1124 035 221
Servicing 0120 468 037, -114
 24 V. 80 Amp.
 L. 165 mm, O.D. 103.3 mm, Shaft 17 mm



138839

Replacing 1124 035 119, -222, -223
Servicing 0120 468 065, -094, -116, -124, -129, -130, -139
 24 V. 75 Amp.
 L. 166.9 mm, O.D. 103 mm, Shaft 17 mm



138264

Replacing 1124 035 260
Servicing 0120 469 102
 24 V. 55 Amp.
 L. 157 mm, O.D. 100 mm, Shaft 17 mm



138836

Replacing 1124 034 076, -126, -220, -613
Servicing 0120 489 533, -534, -611
 12 V. 45 Amp.
 L. 132.8 mm, O.D. 89 mm, Shaft 17 mm



138842

Replacing 1124 035 035, -066, -181
Servicing 0120 469 545, -546, -548, -555, -556, -557, -558, -820, -821
 12 V. 90 Amp.
 L. 160.8 mm, O.D. 100 mm, Shaft 17 mm



138295

Replacing 1124 034 343, -353, -357, -651
Servicing 0120 484 001, -012, -015
 12 V. 95 Amp.
 L. 154 mm, O.D. 93 mm, Shaft 17 mm



138838

Replacing 1124 035 192
Servicing 0120 469 926, -927, -928, -943, -947, -948
 12 V. 80 Amp.
 L. 150.7 mm, O.D. 100 mm, Shaft 17 mm



138843

Replacing 1124 034 177, -581, -768
Servicing 0120 489 156, -756
 12 V. 65 Amp.
 L. 154.1 mm, O.D. 89 mm, Shaft 17 mm

Replacing BOSCH



138844

Replacing 1124 034 240, -616
Servicing 0120 489 120, -121, -122, -125
 12 V. 45/55 Amp.
 L. 148.5 mm, O.D. 89 mm, Shaft 17 mm



139260

Replacing 1124 034 910, -911
Servicing 0123 315 008, -015, -017, -018, -019
 12 V. 75/95 Amp.
 L. 148 mm, O.D. 93.2 mm, Shaft 17 mm



139527

Replacing 1124 035 076, -190
Servicing 0120 469 744, -745, -746, -811, -812, -894, -896
 12 V. 90 Amp.
 L. 150.5 mm, O.D. 100 mm, Shaft 17 mm



138845

Replacing 1124 034 224, -267, -617
Servicing 0120 489 948, -949
 12 V. 45 Amp.
 L. 148.7 mm, O.D. 88.9 mm, Shaft 17 mm



139405

Replacing 1124 035 238
Servicing 0120 469 010, -022, -023, -026, -027, -031, -037, -978, -999
 24 V. 55 Amp.
 L. 161 mm, O.D. 100 mm, Shaft 17 mm



139746

Replacing 1124 035 169
Servicing 0120 469 526
 12 V. 90 Amp.
 L. 172.6 mm, O.D. 100 mm, Shaft 17 mm



138846

Replacing 1124 034 170, -595, -778, -779
Servicing 0120 489 723, -724
 12 V. 35 Amp.
 L. 149 mm, O.D. 89 mm, Shaft 17 mm



139433

Replacing 1124 035 068, -167
Servicing 0120 469 008, -036, -041, -585, -796, 6033 GB3 053
 24 V. 55 Amp.
 L. 172.6 mm, O.D. 100 mm, Shaft 17 mm



139805

Replacing 1124 035 261
Servicing 0120 469 115, -116, 6033 G3B 022, 6033 GB3 019, -022, -027
 24 V. 80 Amp.
 L. 167 mm, O.D. 103.3 mm, Shaft 17 mm

Replacing BOSCH



139806

Replacing 1124 035 064, -180
Servicing 0120 469 522, -749
 12 V. 90 Amp.
 L. 160.9 mm, O.D. 100 mm, Shaft 17 mm



230978

Replacing 1124 035 213
Servicing 0120 468 028, -055
 12 V. 130 Amp.
 L. 201 mm, O.D. 103 mm, Shaft 22 mm



230992

Replacing 1124 035 471
Servicing 0123 515 013
 12 V. 115 Amp.
 L. 165 mm, O.D. 103 mm, Shaft 17 mm



230357

Replacing 1124 034 381
Servicing 0120 400 702, -703, -752, -753, -794, -795
 12 V. 45 Amp.
 L. 126 mm, O.D. 89 mm, Shaft 17 mm



230979

Replacing 1124 035 257
Servicing 0120 468 135, -144, -146, 0120 469 104, -105, 6033 GB3 021, -045, -048
 24 V. 80 Amp.
 L. 174.5 mm, O.D. 103 mm, Shaft 17 mm

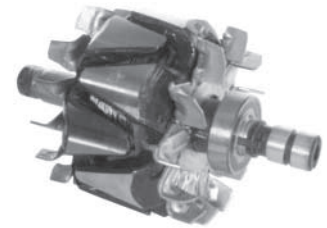

231070

Replacing F00M 111 606
Servicing 0124 225 001, -002, -004, -009, -022, -023, -024, -025
 12 V. 70 Amp.
 L. 144 mm, O.D. 89 mm, Shaft 17 mm



230849

Replacing F00M 121 611
Servicing 0124 320 001, -002, 0124 325 001, -002, -003, -004, -011, -012, -013, -014, -015, -016, -017, -018
 12 V. 90 Amp.
 L. 153 mm, O.D. 93 mm, Shaft 17 mm



230980

Replacing 9121 064 050
Servicing 9120 060 027
 12 V. 37 Amp.
 L. 154 mm, O.D. 93 mm, Shaft 17 mm



231199

Replacing 1124 035 158
Servicing 0120 450 011, -012, -013, -014, -016, -017
 12 V. 100 Amp.
 L. 156 mm, O.D. 100.5 mm, Shaft 17 mm

Replacing BOSCH



231250

Replacing F00M 131 603
Servicing 0124 515 017, -018, -019, -054, 0124 525 001, -014
 12 V. 120/140 Amp.
 L. 156 mm, O.D. 103 mm, Shaft 17 mm
 M16-1.5, Anti CW rotation



231280

Replacing 2124 037 064
Servicing 0120 689 562
 24 V. 140 Amp.
 L. 235 mm, O.D. 125 mm, Shaft 30 mm



231662

Replacing F00M 121 601, -610
Servicing 0124 315 001, -002, -003, -004, -005, -006, -007, -008, -010, -011, -012, -013, -014, -018, -020, -021, -022, -026
 12 V. 70 Amp.
 L. 153 mm, O.D. 93 mm, Shaft 17 mm

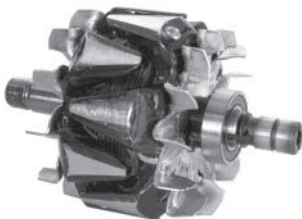

231256

Replacing F00M 121 614
Servicing 0124 415 006
 12 V. 105 Amp.
 L. 150 mm, O.D. 98 mm, Shaft 17 mm



231349

Replacing 1124 034 131, -552, -753
Servicing 0120 489 726, 9120 080 113, -158, -218
 12 V. 55 Amp.
 L. 165.5 mm, O.D. 89 mm, Shaft 17 mm

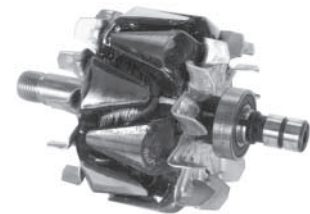

231682

Replacing F00M 121 619
Servicing 0124 415 007, -013, -014
 12 V. 70 Amp.
 L. 153 mm, O.D. 98 mm, Shaft 17 mm



231270

Replacing F00M 121 604
Servicing 0124 325 006
 12 V. 90 Amp.
 L. 150 mm, O.D. 93 mm, Shaft 17 mm

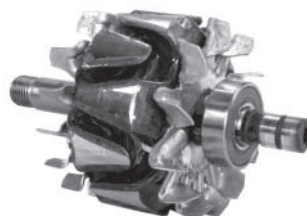

231637

Replacing 1124 034 939
Servicing 0120 485 047, 0123 310 042
 12 V. 70 Amp.
 L. 157.5 mm, O.D. 93 mm, Shaft 17 mm



231754

Replacing F00M 131 607, -623
Servicing 0124 515 001, -004, -005, -006, -023, -031, -032, -033, -049, -080, -081, -082, -085, -086, -089, -095, -096
 12 V. 120 Amp.
 L. 156 mm, O.D. 102 mm, Shaft 17 mm

Replacing BOSCH



231934

Replacing F00M 121 612
Servicing 0124 415 001, -002, -005, -008, -009, -010, -023, -025, -026, -028
 12 V. 100 Amp.
 L. 150.1 mm, O.D. 98.3 mm, Shaft 17 mm



232235

Replacing 1124 034 436, -751, -903, -907
Servicing 0120 485 048, 0123 315 013, 0123 320 016, -026, 0123 335 001
 12 V. 80/90 Amp.
 L. 161 mm, O.D. 94 mm, Shaft 17 mm

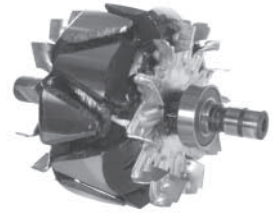

233471

Replacing F00M 131 610
Servicing 0124 615 002
 12 V. 150 Amp.
 L. 157.3 mm, O.D. 111.3 mm, Shaft 17 mm



232040

Replacing 9122 334 037
Servicing 0120 468 143, 6033 GB3 023
 24 V. 100 Amp.
 L. 175.5 mm, O.D. 103.7 mm, Shaft 17 mm



232266

Replacing 1124 035 240
Servicing 0120 468 127, -128, -134
 40 V. 90 Amp.
 L. 168.9 mm, O.D. 103.3 mm, Shaft 17 mm



233526

Replacing F00M 121 621
Servicing 0124 315 019, -027
 12 V. 75 Amp.
 L. 153.3 mm, O.D. 93.3 mm, Shaft 17 mm



232198

Replacing F00M 131 608
Servicing 0124 515 010
 12 V. 120 Amp.
 L. 159 mm, O.D. 103 mm, Shaft 17 mm



233321

Replacing 1124 035 400, -438, -466, -503
Servicing 0120 465 009, -011, -020, -021, -026, -027, -028, 0123 505 005, -010, 0123 510 009, -017, 0123 540 001
 12 V. 120 Amp.
 L. 165 mm, O.D. 103 mm, Shaft 17 mm



233646

Replacing 1124 035 259
Servicing 0120 469 101
 24 V. 65 Amp.
 L. 168.7 mm, O.D. 100.3 mm, Shaft 17 mm

Replacing BOSCH

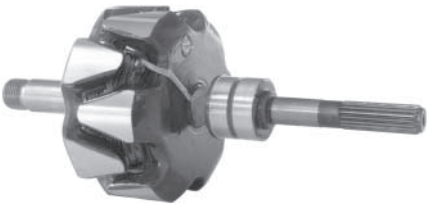

233700

Replacing 9122 334 025
Servicing 9120 334 625, -625, -635
 12 V. 70 Amp.
 L. 207 mm, O.D. 89 mm, Shaft 17 mm,
 19 Splines



233863

Replacing 1124 035 486
Servicing 0123 515 028
 12 V. 115 Amp.
 L. 155 mm, O.D. 103.2 mm, Shaft 17 mm



234095

Replacing 1124 033 018, -027
Servicing 0120 340 002, -003, -004, -005
 12 V. 20 Amp.
 L. 83 mm, O.D. 73 mm



233717

Replacing 1124 035 464, -502
Servicing 0123 510 048
 12 V. 120 Amp.
 L. 164.5 mm, O.D. 103 mm, Shaft 17 mm



233924 OE

Replacing 1124 035 528, -535, -540
Servicing 0123 520 017
 12 V. 150 Amp.
 L. 158.9 mm, O.D. 111.2 mm, Shaft 17 mm

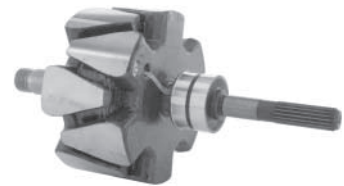

234361

Replacing 9122 334 032 
Servicing 6033 GB 5001, -5007, -5009,
 -5011, 9220 335 002
 12 V. 90 Amp. 18 splines
 L. 218 mm, O.D. 100 mm, Shaft 17 mm



233854

Replacing F00M 111 609
Servicing 0124 225 010, -037
 12 V. 75 Amp.
 L. 151 mm, O.D. 89 mm, Shaft 17 mm



233973

Replacing 1124 035 522, -541, -544
Servicing 0123 525 500, -502, -503
 24 V. 90 Amp.
 L. 159 mm, O.D. 111.3 mm, Shaft 17 mm



234423

Replacing F00M 131 604
Servicing 0124 510 001, 0124 515 015,
 -028, -040, -042, -044, -073, -113, -120
 12 V. 120 Amp.
 L. 159 mm, O.D. 103 mm, Shaft 17 mm

Replacing BOSCH



234523

Replacing 1124 035 530, -543
Servicing 0123 525 501
 24 V. 90 Amp.
 L. 177 mm, O.D. 111 mm, Shaft 17 mm



235054

Replacing F00M 131 645 
Servicing 0124 555 001, -002, -004, -007, -011, -012, -015, -016, -021, -022, -023, -025, -029
 24 V. 80 Amp.
 L. 162 mm, O.D. 103 mm, Shaft 17 mm



235325

Replacing F00M 131 626 
Servicing 0124 525 016
 12 V. 140 Amp.
 L. 164.5 mm, O.D. 103 mm, Shaft 17 mm



234656

Replacing 1124 035 515
Servicing 0123 515 022, -023, -030
 12 V. 120 Amp.
 L. 163 mm, O.D. 103.3 mm, Shaft 17 mm



235219

Replacing F00M 131 631 
Servicing 0124 615 006, -007, -008, -009, -012, -013, -014, -015, -016, -017, -018, -019, -020, -021, -022, -025, -026, -028
 12 V. 150 Amp.
 L. 162 mm, O.D. 111 mm, Shaft 17 mm

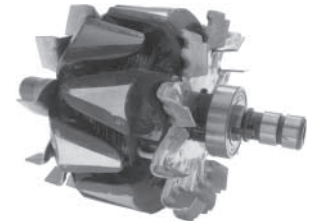

235326

Replacing F00M 131 634, F00M 131 639 
Servicing 0124 525 028, -034, -035, -043, -044, -047, -049, -076, -082
 12 V. 150 Amp.
 L. 157 mm, O.D. 103 mm, Shaft 17 mm



234776

Replacing F00M 111 607 
Servicing 0124 225 015, -016, -019, -021, -026, -027, -035
 12 V. 85 Amp.
 L. 148 mm, O.D. 89 mm, Shaft 17 mm



235255

Replacing F00M 131622 
Servicing 0124 525 008, -009, -010, -027, -039, -050, -066, -067
 12 V. 120 Amp.
 L. 159 mm, O.D. 103 mm, Shaft 17 mm



235341

Replacing 1124 034 970, -977 
Servicing 0123 325 500
 24 V. 55 Amp.
 L. 170.5 mm, O.D. 93.3 mm, Shaft 17 mm

Replacing BOSCH



239238

Replacing 1124 035 506
Servicing 0124 325 003, -137
 12 V. 115 Amp.
 L. 164.5 mm, O.D. 103 mm, Shaft 17 mm



Rotor Parts



133435

Servicing 9121 144 005, -019,
 Cargo 132850
 L. 200 mm, Shaft 17 mm, 18 Splines
 Rotor shaft



133910

Servicing 1124 034 311, Cargo 134097
 L. 149 mm, Shaft 17 mm
 Rotor shaft



133799

Servicing 1124 034 119, -169,
 Cargo 130092, 131073
 L. 157 mm, Shaft 17 mm
 Rotor shaft



135329

Servicing 1124 035 077, Cargo 133444
 L. 172 mm, Shaft 17 mm
 Rotor shaft



133800

Servicing 1124 034 172, -175,
 Cargo 132347, 132348
 L. 148 mm, Shaft 17 mm
 Rotor shaft



137223

Servicing 9121 144 037, 9122 334 021,
 Cargo 136286
 L. 210 mm, Shaft 17 mm, 18 Splines
 Rotor shaft



133801

Servicing 1124 035 024, -058,
 Cargo 133188
 L. 175 mm, Shaft 17 mm
 Rotor shaft



139894

Servicing 1124 034 258, -643,
 Cargo 134710
 L. 165 mm, Shaft 17 mm
 Rotor shaft

Replacing BOSCH



233750

Servicing 1124 034 246, -354, -668, Cargo 131957
L. 149 mm, Shaft 17 mm
Rotor shaft



132324 Std pkg 10 A

Replacing 1900 023 008
4 x 6.5 x 16 mm
Key



230822

Replacing 2120 202 006
Servicing 0120 689 502, -503, -504, -505, -506, -507, -508, -510, -511, -512, -513, -514, -515, -516, -517, -518, -521, -525
O.D. 38 mm, Bore 30 mm, Th. 13 mm
Rotor spacer

233832

Servicing 1124 035 416, -420, -442, -457, -458, -463, -464, -467, -471, -474, -500, -501, -502, -506, Cargo 137511, 230992, 233717
L. 160 mm, Shaft 17 mm
Rotor shaft



133785 Std pkg 10 A

Replacing 1900 023 004
3 x 3.7 x 10 mm
Key

234583

Servicing 0120 468 029, -101, -135
O.D. 30.95 mm, Bore 17 mm, Th. 9.77 mm
Rotor spacer



234421

Servicing 1124 034 403, -414, -444, -452, -467, -470, -477, -929, -931, -932, -948, Cargo 136360, 137331, 137787
L. 149 mm, Shaft 17 mm
Rotor shaft



139025

Replacing 1120 114 002
Servicing 0120 689 ...
O.D. 40 mm, Bore 30 mm, Th. 10 mm
Rotor spacer



139026

Replacing 2916 600 016
Servicing 0120 689 ...
Rotor circlip



130936 Std pkg 10 A

4 x 5 x 12.65 mm
Key



139040 Std pkg 5

O.D. 22.5/28 mm, Bore 17 mm, Th. 6 mm
Rotor spacer



133612 Std pkg 5 A

M15-1.5
Rotor shaft nut set

Replacing BOSCH



139333
Replacing 1127 011 166
Servicing 0120 689 522, -527, -540, -541
 M27-3.0
 Rotor shaft nut set



138775 Std pkg 5
Replacing 1127 011 100
 M16-1.5
 Nut for rotor



139930 Std pkg 5
Replacing F00M 990 132
Servicing 0124 515 017
 M16-1.5
 Anti CW rotation
 Nut for rotor



234137
 Part of Cargo 136010
 M24-1.5
 Nut for rotor



231564
Servicing 1126 601 568
 M16-1.5
 Nut for rotor



234710 
Servicing 0120 400 640, -642, -694, -708, -791, -835
 6.75 x 15.3 x 1.45 mm
 Washer

Stators



130097
Replacing 1125 043 007
Servicing 0120 300 518, -519, -531, -533, -536, -537, -545, -546, -547, -548, -552, -562, -575, -577, -578, -584, -585, -586
 12 V. 28 Amp.
 O.D. 108.9 mm, I.D. 73.8 mm, W. 22.5 mm



130099
Replacing 1125 043 004
Servicing 0120 300 529, -539, -550, -551, -558, -559, -563, -564, -569, -588, -592, 0120 339 510, -512, -516, -523, -531, -532
 12 V. 33 Amp.
 O.D. 107.9 mm, I.D. 73.8 mm, W. 21 mm



130100
Replacing 1125 045 010
Servicing 0120 400 602, -603, -605, -608, -609, -611, -615, -621, -623, -625, -631, -639, -645, -653, -655, -657, -659, -661
 12 V. 35 Amp.
 O.D. 125.1 mm, I.D. 88.9 mm, W. 17.6 mm

Replacing BOSCH



130101

Replacing 1125 045 012
Servicing 0120 400 722, -723, -733, -743, -747, -772, -782, -783, -806, -807, -809, -810, -853, -859, -869, -873, -885, -899
 12 V. 55 Amp.
 O.D. 125.3 mm, I.D. 89.3 mm, W. 24.1 mm



130106

Replacing 1125 045 047, 1124 229 026
Servicing 0120 400 617, -695, -708, -720, -784, -887, 0120 489 053, -192, -224, -230, -320, -684, -702, -731, -827, -944
 24 V. 35 Amp.
 O.D. 125.3 mm, I.D. 89 mm, W. 24.4 mm



131126

Replacing 1125 045 002
Servicing 0120 400 633, -668, -684, -754, -755, -785, -796, -797, -842, -877
 24 V. 35 Amp.
 O.D. 124.9 mm, I.D. 89.1 mm, W. 24 mm



130102

Replacing 1125 045 018
Servicing 0120 400 640, -642, -664, -666, -685, -690, -694, -699, -715, -732, -773, -774, -790, -791, -799, -805, -826, -830
 24 V. 27 Amp.
 O.D. 125 mm, I.D. 89 mm, W. 17.6 mm



131039

Replacing 1124 229 027
Servicing 0120 400 619, -691, -737, -775, -845, -892, -897, -907
 12 V. 35 Amp.
 O.D. 124.9 mm, I.D. 88.9 mm, W. 17.5 mm



131457

Replacing 1125 045 056
Servicing 0120 489 023, -727, -728
 24 V. 27 Amp.
 O.D. 125.2 mm, I.D. 88.9 mm, W. 17.2 mm



130105

Replacing 1125 045 045
Servicing 0120 400 905, 0120 489 060, -071, -303, -388, -481, -640, -643
 24 V. 45 Amp.
 O.D. 125 mm, I.D. 89.3 mm, W. 23.6 mm



131045

Replacing 1125 045 105
Servicing 0120 469 509, -518, -527, -549, -562, -634, -673, -679, -761
 24 V. 55 Amp.
 O.D. 137.6 mm, I.D. 100.8 mm, W. 23.8 mm



132091

Replacing 1125 045 102, -130, -137
Servicing 0120 450 003, 0120 469 506, -507, -515, -522, -526, -532, -534, -535, -546, -547, -548, -556, -557, -558, -566
 12 V. 90 Amp.
 O.D. 138 mm, I.D. 101 mm, W. 24 mm

Replacing BOSCH



132351

Replacing 1125 045 021
Servicing 0120 488 004, -005, 0120 489 629, 9120 080 135, 9120 144 016, -204, -209, -215, -222
 12 V. 45 Amp.
 O.D. 124.8 mm, I.D. 88.9 mm, W. 23.5 mm



132354

Replacing 1125 045 053
Servicing 0120 488 009, -103, 0120 489 026, -073, -079, -162, -184, -190, -254, -273, -275, -276, -279, -298, -299
 12 V. 70 Amp.
 O.D. 125.1 mm, I.D. 89 mm, W. 26.2 mm



133294

Replacing 1125 045 100, -135
Servicing 0120 469 501, -503, -504, -505, -511, -525, -528, -533, -537, -539, -542, -543, -544, -552, -553, -554, -561, -576
 12 V. 80 Amp.
 O.D. 138 mm, I.D. 100.5 mm, W. 23.9 mm



132352

Replacing 1125 045 044
Servicing 0120 489 033, -034, -035, -055, -411, -412, -413, -638, -639, -661, -682, -707, -730, -733, -793, -794, -795, -796
 24 V. 27 Amp.
 O.D. 125 mm, I.D. 88.8 mm, W. 17.5 mm



133081

Replacing 1125 045 043, -063
Servicing 0120 400 725, -945, 0120 488 001, 0120 489 003, -004, -005, -007, -017, -021, -024, -029, -031, -037
 12 V. 65 Amp.
 O.D. 125 mm, I.D. 89.6 mm, W. 25.7 mm



133474

Replacing 1125 045 061
Servicing 0120 489 368, -373, -377, -380, -433, -440, -443, -444, -496
 12 V. 45 Amp.
 O.D. 125.1 mm, I.D. 89.1 mm, W. 24.1 mm



132353

Replacing 1125 045 051
Servicing 0120 400 745, -839, -840, -841, -900, -901, -902, -903, -906, 0120 489 012, -013, -014, -015, -018, -019, -047, -049
 12 V. 45 Amp.
 O.D. 124.8 mm, I.D. 89 mm, W. 24.3 mm



133105

Replacing 1125 045 106
Servicing 0120 450 009, 0120 469 513, -517, -531, -564, -568, -570, -572, -574, -628, -656, -657, -658, -664, -668, -670
 12 V. 70 Amp.
 O.D. 138.1 mm, I.D. 100.5 mm, W. 24.1 mm



133846

Replacing 1125 045 059
Servicing 0120 489 227, -316
 24 V. 30 Amp.
 O.D. 125 mm, I.D. 89.1 mm, W. 23.6 mm

Replacing BOSCH



134565

Replacing 1125 045 195
Servicing 0120 468 017, -019, -020, -022, -042, -043
 12 V. 110 Amp.
 O.D. 141.7 mm, I.D. 103.3 mm, W. 29.4 mm



135613

Replacing 1125 045 075
Servicing 0120 484 002, -003, -004, -005, -006, -007, -008, -009, -010, -013, -014, -016, -023
 12 V. 85 Amp.
 O.D. 124.9 mm, I.D. 93.3 mm, W. 26.9 mm



135617

Replacing 1125 045 557
Servicing 0120 465 008, -023
 12 V. 120 Amp.
 O.D. 145.1 mm, I.D. 104.2 mm, W. 35.5 mm



134731

Replacing 1125 047 001, -003
Servicing 0120 689 503, -504, -505, -506, -507, -508, -510, -512, -514, -515, -516, -523, -524, -525
 24 V. 95 Amp.
 O.D. 166.2 mm, I.D. 125.1 mm, W. 44.5 mm



135615

Replacing 1125 045 222, -232, -534
Servicing 0120 485 029, -034, -043, -044, -046, -047, 0123 310 001, -002, -003, -007, -014, -022, -027, -031, -042, -043, -044
 12 V. 70 Amp.
 O.D. 128 mm, I.D. 93.5 mm, W. 27.4 mm



135904

Replacing 1125 045 212, -233, -234, -537
Servicing 0120 485 017, -018, -020, -023, -025, -026, -028, -030, -034, -036, -038, -039, -043, -044, -046, 0123 310 004
 12 V. 90 Amp.
 O.D. 128 mm, I.D. 94 mm, W. 32.2 mm



134929

Replacing 1125 045 096, -097
Servicing 0120 485 015
 12 V. 80 Amp.
 O.D. 128 mm, I.D. 93.3 mm, W. 31.2 mm



135616

Replacing 1125 045 306, -317
Servicing 0120 465 010, -011, -012, -018, -020, -021, -029, 0123 213 005, -006, -007, 0123 545 001, -002
 12 V. 120 Amp.
 O.D. 142.2 mm, I.D. 103.7 mm, W. 36.4 mm



135990

Replacing 1125 045 092, -213
Servicing 0120 485 011, -012, -022, 0123 310 005, 0123 315 005, 0123 335 004
 12 V. 70 Amp.
 O.D. 128 mm, I.D. 93 mm, W. 32.9 mm

Replacing BOSCH



135998

Replacing 1125 047 004, -005,
Servicing 0120 689 506, -511-513, -517,
 -518, -520, -522, -526, -528, -531, -531, -
 532, -533, -534, -538, -539, -540, -542, -543
 24 V. 120 Amp.
 O.D. 166 mm, I.D. 125.8 mm, W. 45 mm



136373

Replacing 1125 045 511
Servicing 0123 310 015, -029
 12 V. 70 Amp.
 O.D. 128.1 mm, I.D. 93.7 mm, W. 27.2 mm



136588

Replacing 1125 045 168
Servicing 0120 468 066
 24 V. 100 Amp.
 O.D. 141.9 mm, I.D. 103.6 mm, W. 29.3 mm



136037

Replacing 1125 045 152, -167
Servicing 0120 468 037, -065, -093, -094,
 -114, -116, -124, -129, -130
 24 V. 80 Amp.
 O.D. 142.1 mm, I.D. 103.6 mm, W. 28.8 mm



136463

Replacing 2125 007 022
Servicing 0120 689 519, -529, -536, -537,
 -544, -547
 24 V. 180 Amp.
 W/ bracket



136702

Replacing 1125 045 229, -507, -540
Servicing 0123 310 006, -010, -011, -012, -
 013, -018, -019, -020, -024, -025, -032,
 -034, -035, -037, -040, -049
 12 V. 80 Amp.
 O.D. 128 mm, I.D. 93.3 mm, W. 29.6 mm



136346

Replacing 1125 045 227
Servicing 0123 310 008, -017, -030,
 0123 315 016, 0123 320 004, -010, -011,
 -022, 0123 335 002, -003, -005, -006, -008
 12 V. 90 Amp.
 O.D. 127.6 mm, I.D. 94.3 mm, W. 32.4 mm



136483

Replacing 1125 043 034, -035, -513, -514
Servicing 0123 100 003, 0123 110 005,
 -006, 0123 120 001
 12 V. 70 Amp.
 O.D. 119 mm, I.D. 89.1 mm, W. 32.2 mm



136825

Replacing 1125 045 141
Servicing 0120 468 009, -010, -011, -012,
 -015, -016, -057, -058, -059, -060, -080,
 -081, -084, -085, -086, -119, -120, -122
 12 V. 100 Amp.
 O.D. 142.1 mm, I.D. 103.4 mm, W. 29 mm

Replacing BOSCH



136830

Replacing 1125 045 579
Servicing 0123 500 007, -008, -009, 0123 505 002, -003, 0123 510 043, -062, -063, -064, -069
 12 V. 120 Amp.
 O.D. 142 mm, I.D. 103 mm, W. 27.5 mm



137243

Replacing 1125 045 146
Servicing 0120 468 063, -064, -077, -078, -102, -103, -104, -105, -110, -111
 12 V. 140 Amp.
 O.D. 141.8 mm, I.D. 103.4 mm, W. 29.3 mm



137318

Replacing 1125 043 048
Servicing 0120 335 006, 0123 105 001
 12 V. 50 Amp.
 O.D. 119 mm, I.D. 89.2 mm, W. 26.1 mm



136841

Replacing 1125 045 225
Servicing 0120 484 017, -019, -021, -027, 6033 GB2 009
 12 V. 120 Amp.
 O.D. 125.1 mm, I.D. 93.6 mm, W. 26.8 mm



137244

Replacing 1125 045 196
Servicing 0120 468 029, -101, -125
 12 V. 115 Amp.
 O.D. 142 mm, I.D. 103.7 mm, W. 28.5 mm



137344

Replacing 1125 045 143
Servicing 0120 468 013, -014, -032, -033, -055, -071, -072, -073, -074, -097, -098
 12 V. 140 Amp.
 O.D. 142 mm, I.D. 103.5 mm, W. 29.2 mm



136842

Replacing 1125 043 503
Servicing 0123 100 001, -002
 12 V. 55 Amp.
 O.D. 118.8 mm, I.D. 89.5 mm, W. 32 mm



137285

Replacing 1125 045 318
Servicing 0120 468 131
 24 V. 70 Amp.
 O.D. 142.1 mm, I.D. 103.7 mm, W. 29.1 mm



137382

Replacing 1125 045 556, -574
Servicing 0123 212 001
 12 V. 90 Amp.
 O.D. 145 mm, I.D. 102.5 mm, W. 29.1 mm

Replacing BOSCH



137467

Replacing 1125 045 200
Servicing 0120 485 050
 12 V. 60 Amp.
 O.D. 127.7 mm, I.D. 92.1 mm, W. 21.4 mm



138054

Replacing 1125 045 220
Servicing 0120 485 048
 12 V. 50 Amp.
 O.D. 127.8 mm, I.D. 92.5 mm, W. 31.3 mm



138059

Replacing 1125 045 543, -544, -560
Servicing 0120 320 006, -007, -008, -017, -018, -019, -024, -027, -031, -032, -034, -035, -038, -058, -059, 0123 325 005
 12 V. 90 Amp.
 O.D. 127.9 mm, I.D. 93.5 mm, W. 32.3 mm



137514

Replacing 1125 045 313
Servicing 0120 465 031
 12 V. 140 Amp.
 O.D. 144.2 mm, I.D. 103.9 mm, W. 35.2 mm



138055

Replacing 1125 045 228, -608
Servicing 0123 325 002, -003, -012, -013, -014
 12 V. 80 Amp.
 O.D. 128 mm, I.D. 93.7 mm, W. 31.4 mm



138060

Replacing 1125 045 555, -588
Servicing 0123 520 001, -002, -003, -004, -005, -014, -019, -020, -021, -026, -027, -031, 0123 525 001
 12 V. 150 Amp.
 O.D. 144.5 mm, I.D. 112.5 mm, W. 35.7 mm



137534

Replacing 1125 043 038, -039, -501
Servicing 0120 335 007
 12 V. 70 Amp.
 O.D. 119.1 mm, I.D. 89.2 mm, W. 32.2 mm



138057

Replacing 1125 045 325
Servicing 0123 510 004, -018, -021
 12 V. 143 Amp.
 O.D. 144.6 mm, I.D. 111.6 mm, W. 36.2 mm



138061

Replacing 1125 045 564
Servicing 0123 510 028
 12 V. 120 Amp.
 O.D. 144.9 mm, I.D. 103.4 mm, W. 34 mm

Replacing BOSCH



138062

Replacing 1125 045 565, -567
Servicing 0123 510 038, -039, -044, -049, -050, -051, -058, -059, -066, -067, -072, -080
 12 V. 120 Amp.
 O.D. 144.6 mm, I.D. 102.2 mm, W. 33.4 mm



138826

Replacing 1125 045 170
Servicing 0120 469 007, -973, -974, -984, -985
 12 V. 105 Amp.
 O.D. 138 mm, I.D. 100.2 mm, W. 23.9 mm



139041

Replacing 1125 043 046
Servicing 0120 335 012, 0123 110 004
 12 V. 70 Amp.
 O.D. 119 mm, I.D. 90 mm, W. 29.3 mm

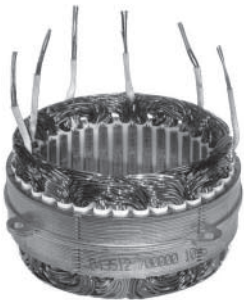

138266

Replacing 1125 043 512
Servicing 0123 110 007
 12 V. 70 Amp.
 O.D. 118.3 mm, I.D. 87.8 mm, W. 31.6 mm



138998

Replacing 1125 045 305
Servicing 0123 214 002, 0123 515 002, -007, -010
 12 V. 140 Amp.
 O.D. 144.6 mm, I.D. 103.4 mm, W. 34.5 mm



139042

Replacing 1125 045 580
Servicing 0123 510 033, -041, -045, -061, -070, -071, -088, -091, -092, 0123 515 012, -024
 12 V. 120 Amp.
 O.D. 144.9 mm, I.D. 103.5 mm, W. 33.9 mm



138267

Replacing 1125 045 073
Servicing 0120 484 001, -011, -012, -015, -018, -022, -024, -025, -026
 12 V. 95 Amp.
 O.D. 125 mm, I.D. 93.6 mm, W. 25.7 mm



139010

Replacing 1125 045 573
Servicing 0123 510 037, -040, -042, -094, -095, 0123 515 003, -008, -009, -013, -014
 12 V. 115 Amp.
 O.D. 142 mm, I.D. 103.9 mm, W. 33.4 mm



139170

Replacing 1125 045 309
Servicing 0120 450 026, -027, -028, -029, -031
 12 V. 120 Amp.
 O.D. 137.8 mm, I.D. 100 mm, W. 24.2 mm

Replacing BOSCH



139300

Replacing 1125 045 223, -224, -503, -582
Servicing 0123 315 004, -008, -017, -018, F010 LD0 201
 12 V. 75 Amp.
 O.D. 127.9 mm, I.D. 93.3 mm, W. 31.6 mm



230123

Replacing 1125 045 509
Servicing 0123 315 007
 12 V. 70 Amp.
 O.D. 127.9 mm, I.D. 93.6 mm, W. 27.4 mm

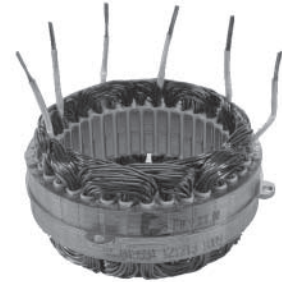

230234

Replacing 1125 045 594
Servicing 0123 510 082, -107, -108
 12 V. 115 Amp.
 O.D. 145 mm, I.D. 104 mm, W. 33.7 mm

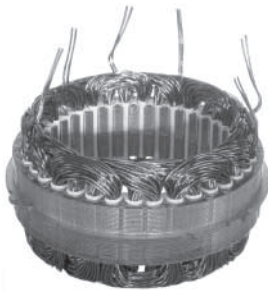

139920

Replacing F00M 130 101
Servicing 0124 515 010, -011, -012, -013, -017, -018, -020, -021, -026, -035, -038, -054
 12 V. 120 Amp.
 O.D. 144 mm, I.D. 103.1 mm, W. 32.9 mm



230181

Replacing F00M 120 107
Servicing 0124 325 001, -002, -003, -004, -014, -018 -021, -022, -023, -024, -028, -034, -041, -042, -043
 12 V. 90 Amp.
 O.D. 132.9 mm, I.D. 92.3 mm, W. 31.2 mm



230563

Replacing 1125 045 577
Servicing 0123 505 013, 0123 510 006, -007, -026, -027, -032, -034, 0123 515 017
 12 V. 120 Amp.
 O.D. 142 mm, I.D. 105 mm, W. 36 mm



139941

Replacing 1125 045 510
Servicing 0123 320 014, -036, -037, -050, -063, 1123 325 006
 12 V. 90 Amp.
 O.D. 127.9 mm, I.D. 93.7 mm, W. 31.6 mm



230183

Replacing 1125 045 587
Servicing 0123 510 068, -079, -081, -100, -101, -102
 12 V. 115 Amp.
 O.D. 142.3 mm, I.D. 93.5 mm, W. 33.8 mm

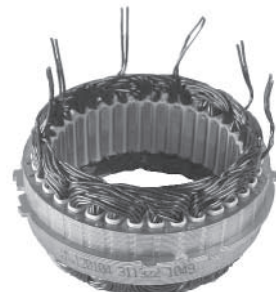

230620

Replacing F00M 120 104
Servicing 0124 325 006, -007, -011, -012, -013, -015, -016, -032, -033, -040, -045
 12 V. 90 Amp.
 O.D. 132.9 mm, I.D. 92.1 mm, W. 31.3 mm

Replacing BOSCH



230621

Replacing F00M 120 106
Servicing 0124 315 001, -002, -003, -006, -011, -012, -018, -020, -021, -022
 12 V. 70 Amp.
 O.D. 132.9 mm, I.D. 93.5 mm, W. 27.4 mm

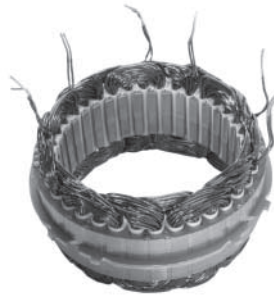

230736

Replacing F00M 120 100
Servicing 0124 415 001, -002, -005, -008, -010
 12 V. 100 Amp.
 O.D. 129 mm, I.D. 99 mm, W. 34 mm



230981

Replacing 9121 064 250
Servicing 9120 060 027
 12 V. 37 Amp.
 O.D. 125 mm, I.D. 94 mm, W. 25.5 mm



230700

Replacing F00M 120 108
Servicing 0124 320 001, 0124 325 010, -039, -046
 12 V. 90 Amp.
 O.D. 133 mm, I.D. 93.4 mm, W. 32.5 mm



230776

Replacing F00M 120 110
Servicing 0124 315 004, -005, -007, -008, -013
 12 V. 70 Amp.
 O.D. 125 mm, I.D. 94 mm, W. 27.5 mm



231255

Replacing F00M 120 109
Servicing 0124 415 006
 12 V. 105 Amp.
 O.D. 130 mm, I.D. 99 mm, W. 34 mm



230710

Replacing 1125 045 330
Servicing 0120 468 127, -128
 36 V. 90 Amp.
 O.D. 141.9 mm, I.D. 103.4 mm, W. 31.1 mm

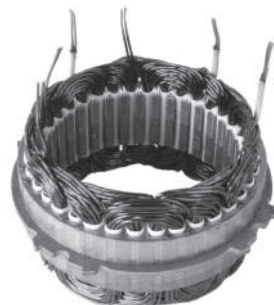

230971

Replacing F00M 110 110
Servicing 0124 225 010, -011, -020
 12 V. 75 Amp.
 O.D. 116 mm, I.D. 89.5 mm, W. 31 mm



231589

Replacing 9121 334 136
Servicing 0120 468 143, -145, 6033 GB3 010, -023
 24 V. 100 Amp.
 O.D. 142 mm, I.D. 103.3 mm, W. 61.3 mm

Replacing BOSCH



231713

Replacing F00M 130 102
Servicing 0124 515 004, -005, -006, -008, -023, -031, -032, -043, -049, -080, -081, -082, -085, -086, -089
 12 V. 120 Amp.
 O.D. 136 mm, I.D. 104 mm, W. 33.5 mm



233470

Replacing F00M 130 105
Servicing 0124 615 002
 12 V. 150 Amp.
 O.D. 142 mm, I.D. 111.7 mm, W. 36 mm



233562

Replacing F00M 120 114
Servicing 0124 415 011, -012, -015
 12 V. 90/105 Amp.
 O.D. 129 mm, I.D. 99 mm, W. 33.5 mm

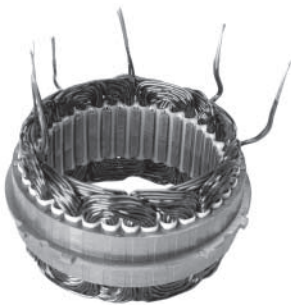

231759

Replacing F00M 110 100, -101
Servicing 0124 215 001, -002, -003, -004, -005, -006, -008, 0124 220 002, 0124 225 001, -004, -009, -012, -013, -014, -015, -016, -019, -021, -026, -027
 12 V. 85 Amp.
 O.D. 116 mm, I.D. 90 mm, W. 31 mm



233473

Replacing 1125 045 653
Servicing 0123 520 023
 12 V. 150 Amp.
 O.D. 142 mm, I.D. 112 mm, W. 36 mm



233763

Replacing 1125 045 581
Servicing 0123 505 018, 0123 510 046, -047, -053, -054, -056, -065, -099, 0123 515 016, -018, -020, -021
 12 V. 120 Amp.
 O.D. 136.9 mm, I.D. 99.2 mm, W. 33.3 mm



231799

Replacing 1125 045 589
Servicing 0123 512 500, -501, -502
 12 V. 120 Amp.
 O.D. 142 mm, I.D. 104 mm, W. 34 mm



233557

Replacing F00M 120 111
Servicing 0124 315 016, -024, -025, 0124 325 009, -054, -055, -058, -060, -065, -079
 12 V. 80/100 Amp.
 O.D. 124.9 mm, I.D. 93.5 mm, W. 33.2 mm



233926

Replacing 1125 045 321, -323, -566, -570
Servicing 0123 505 001, -004, 0123 510 003, -020, -052
 12 V. 120 Amp.
 O.D. 144.7 mm, I.D. 103.7 mm, W. 27.7 mm

Replacing BOSCH



234356

Replacing 1125 045 597
Servicing 1123 525 500, -502, -503
 24 V. 90 Amp.
 O.D. 142 mm, I.D. 112 mm, W. 35.5 mm



234528

Replacing F00M 120 103
Servicing 0124 415 007, -013, -014
 12 V. 90 Amp.
 O.D. 132.8 mm, I.D. 93.6 mm, W. 35.3 mm



234780

Replacing F00M 130 104 
Servicing 0124 515 022, -039, -068, -087, -090, -101
 12 V. 120 Amp.
 O.D. 136 mm, I.D. 104 mm, W. 32.7 mm



234364

Replacing F00M 120 121
Servicing 0124 415 009, -016, -025, -026, -030, -032
 12 V. 100 Amp.
 O.D. 129 mm, I.D. 99 mm, W. 33.5 mm



234547

Replacing 1125 045 525
Servicing 0123 310 033, -051, -052
 12 V. 70 Amp.
 O.D. 125 mm, I.D. 94 mm, W. 33.8 mm



234781

Replacing F00M 120 105 
Servicing 0124 320 002
 12 V. 90 Amp.
 O.D. 125 mm, I.D. 94 mm, W. 31.1 mm

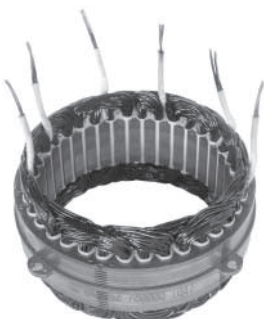

234524

Replacing 1125 045 652
Servicing 0123 525 501
 24 V. 90 Amp.
 O.D. 142 mm, I.D. 112 mm, W. 35.3 mm



234698

Replacing 1125 043 500 
Servicing 0123 115 009, -014
 12 V. 70 Amp.
 O.D. 116 mm, I.D. 89.5 mm, W. 33 mm

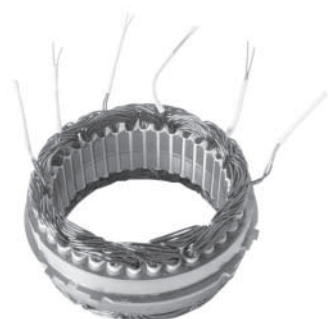

234784

Replacing F00M 130 103 
Servicing 0124 515 024, -025, -027, -028, -034, -040, -058
 24 V. 120 Amp.
 O.D. 136 mm, I.D. 103 mm, W. 33 mm

Replacing BOSCH



234834



Replacing 1125 045 011, -020, -026
Servicing 0120 400 702, -703, -752, -753, -786, -787, -794, -795, -847, -848, -914, -915, -916, -917, -918, -919, -926, -927
 12 V. 45 Amp.
 O.D. 125 mm, I.D. 89.6 mm, W. 17 mm



235055



Replacing F00M 130 112
Servicing 0124 555 001, -002, -003, -004, -007, -008, -011, -012, -013, -014, -015, -016, -018, -021, -022, -025, -029, -030, -032
 24 V. 80 Amp.
 O.D. 136 mm, I.D. 104 mm, W. 33.5 mm



235220



Replacing F00M 120 125
Servicing 0124 325 044, -047, -050, -051, -056, -057, -081, -095, -106, -125, -126, -127
 12 V. 110 Amp.
 O.D. 125.1 mm, I.D. 94 mm, W. 31 mm



234907



Replacing 1125 045 153
Servicing 0120 468 054, -147
 24 V. 65 Amp.
 O.D. 142 mm, I.D. 104 mm, W. 30 mm



235056



Replacing F00M 130 114
Servicing 0124 555 005, -009, -010, -017, -020, -023, -027, -028
 24 V. 70 Amp.
 O.D. 136 mm, I.D. 104 mm, W. 32.7 mm



235321



Replacing 1125 045 614, -617
Servicing 0123 325 500
 24 V. 55 Amp.
 O.D. 125 mm, I.D. 94 mm, W. 32 mm

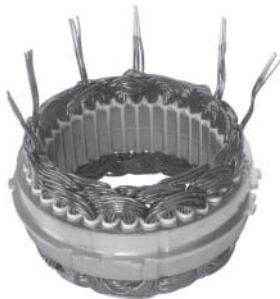

234964



Replacing F00M 120 127
Servicing 0124 325 053, -083, -087
 12 V. 110 Amp.
 O.D. 125.3 mm, I.D. 94 mm, W. 31.4 mm



235231



Replacing 1125 045 023
Servicing 0120 400 634, -635, -643, -644, -647, -648, -652, -679, -680, -686, -687, -692
 12 V. 55 Amp.
 O.D. 125.3 mm, I.D. 89.3 mm, W. 21.1 mm

235352



Replacing 1125 045 088
Servicing 0120 488 206, -294
 24 V. 45 Amp.
 O.D. 89 mm, I.D. 125 mm, W. 24 mm

Replacing BOSCH

Brackets D.E.



236523

Replacing F00M 130 138 
Servicing 0124 615 012, -13, -014, -020, -024, -044, -046, -047, -048
 12 V. 150 Amp.
 O.D. 142 mm, I.D. 112 mm, W. 36 mm



132210

Replacing 1125 824 150
Servicing 0120 400 807, -810, -811, -869, -885, -903, -906, 0120 489 509, -522, -536, -551, -562, -595, -603, -616, -617, -667, -706, -801, -811



132213

Replacing 1125 824 363
Servicing 0120 489 853



238953

Replacing 1125 047 007 
Servicing 0120 689 527, -530, -535, -541, -546, -548, -549, -552, -555, -557, -558, -559, -562, -566, -567, F000 LD0 202, -210, -212
 24 V. 140 Amp.
 O.D. 166.5 mm, I.D. 126 mm, W. 45 mm



132211

Replacing 1125 824 241, -243
Servicing 0120 400 857, 0120 489 548, -623



133888

Replacing 1125 825 018
Servicing 0120 450 009, 0120 469 568, -628, -664, -668, -751, -792



132212

Replacing 1125 824 281
Servicing 0120 400 913, -933, 0120 489 066, -466

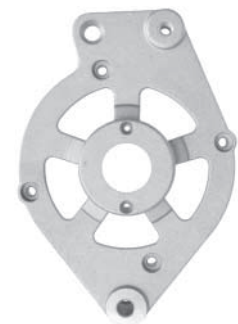

133898

Replacing 1125 824 553
Servicing 0120 488 197, -236, -239, -241, 0120 489 201, -205, -237, -239, -373, -377, -380, -447

Replacing BOSCH



133900

Replacing 1125 825 031
Servicing 0120 469 522, -523



133906

Replacing 1125 824 178, -580
Servicing 0120 489 586, -634, -636



134055

Replacing 1125 824 069, -087
Servicing 0120 400 720, -887, -905, -920, 9120 144 006, -007, -008



133901

Replacing 1125 824 528
Servicing 0120 484 004, -005, -006, -010, -013, -014, 0120 489 025, -026, -184, -253, -254, -274, -275, -276, -279, -298, -299, -310, -311, -312, -321, -322, -354, -355, -359, -898, -899, -928, -930



134021

Replacing 1125 824 403
Servicing 0120 489 164, -194, 9120 144 243, -245



134080

Replacing 1125 824 245
Servicing 0120 489 550, -904



133902

Replacing 1125 824 550, -415
Servicing 0120 489 228, -229, -362, -363, -367, -368, -436, -437, -439, -440, -443, -444



134022

Replacing 1125 824 612
Servicing 0120 488 175, -203



134082

Replacing 1125 824 583
Servicing 0120 489 027, -192, -387, -702

Replacing BOSCH



134118

Replacing 1125 824 123, -124
Servicing 0120 400 669, -670, -724, -733, -745, 0120 489 008, -009, -010, -011, -014, -015, -043, -044, -062, -250, -500, -501, -519, -520, -521, -523, -532, -535, -545, -546, -569, -580, -600, -622, -652

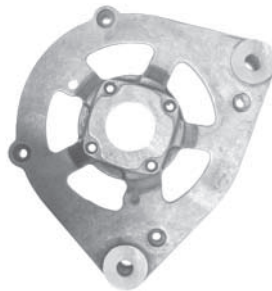

134128

Replacing 1125 825 218
Servicing 0120 469 524, -525, -579, -580, -583, -584, -772



134311

Replacing 1125 824 217
Servicing 0120 400 830



134124

Replacing 1125 824 436
Servicing 0120 488 176, -177, -182, -210, 0120 489 001, -047, -048, -051, -074, -075, -084, -086, -087, -088, -090, -091, -092, -093, -095, -103, -148, -175, -176, -214, -266, -267, -268, -269, -289, -290



134137

Replacing 1125 825 009
Servicing 0120 469 506, -509, -518, -526, -540



134312

Replacing 1125 824 298
Servicing 0120 489 060, -643

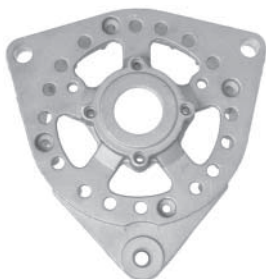

134126

Replacing 1125 824 432
Servicing 0120 489 315, -316
Mounting bushing: Cargo 233569



134303

Replacing 1125 824 212, -593
Servicing 0120 400 859, 0120 489 033, -034, -035, -055, -061, -388, -470, -527, -556, -683, -733, -786, -828, -878, -902, -918, -931, -932, -933, -994, -995, -996, 9120 144 270



134313

Replacing 1125 824 317
Servicing 0120 489 723, -724, -727, -728
Mounting bushing: Cargo 233569

Replacing BOSCH

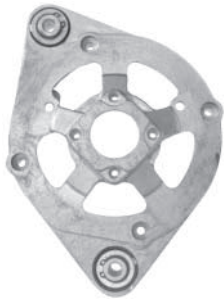

134314

Replacing 1125 824 327
Servicing 0120 489 031, -040, -167, -718



134335

Replacing 1125 824 382
Servicing 0120 489 944
Mounting bushing: Cargo 233569



134397

Replacing 1125 823 007
Servicing 0120 300 533, -552, -564, -579,
 0120 339 574, -526, -531, -538, -542,
 9120 143 222
 W/ bearing



134321

Replacing 9121 145 824
Servicing 9120 144 280



134336

Replacing 1125 824 624
Servicing 0120 488 141, -188, -207, -222,
 -223



134398

Replacing 1125 823 060
Servicing 0120 300 568, -569,
 0120 339 515, -516, -523, -527, -528



134333

Replacing 1125 824 226
Servicing 0120 489 020, -135, -170, -308,
 -402, -542, -570, -743, -822, 9120 144 238,
 -239



134338

Replacing 1125 824 324
Servicing 0120 489 716, -906



134405

Replacing 1125 825 113
Servicing 0120 469 689, -690, -709, -831

Replacing BOSCH



134443

Replacing 1125 824 545
Servicing 0120 489 016, -017, -077, -081, -262, -283, -425, -429, -430, -431, -434, -435, -774, -868, -869, -871, -873, -980, -981, -982, -983



134535

Replacing 1125 824 452
Servicing 0120 489 361



134638

Replacing 1125 824 369, -371
Servicing 0120 489 227, -885, -886
Mounting bushing: Cargo 233569



134529

Replacing 1125 824 538
Servicing 0120 489 331, -332, -333

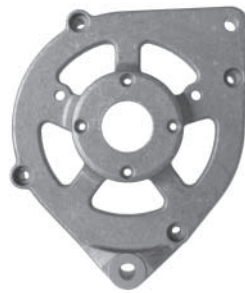

134564

Replacing 1125 825 038
Servicing 0120 469 563, -564, -608, -609, -665, -669



134678

Replacing 1125 824 292
Servicing 0120 400 943, 0120 488 194, -195, -252, -253, -266, -288, 0120 489 018, -106, -107, -144, -145, -146, -147, -151, -410, -411, -412, -413, -612, -638, -639



134534

Replacing 1125 824 247
Servicing 0120 400 836, -837, -863, 0120 489 565, -566, -584



134636

Replacing 1125 825 078, -176, -262
Servicing 0120 469 581, 582, -586, -587, -600, -604, -605, -632, -633, -635, -636, -638, -654, -697, -698, -699, -700, -702, -703, -704, -705, -708, -712, -714, -720, -727, -728, -729, -730, -731, -732, -733



134706

Replacing 1125 825 229, -355
Servicing 0120 469 920

Replacing BOSCH



134865

Replacing 1125 825 023
Servicing 0120 469 527, -562, -761



134900

Replacing 1125 824 419, -554
Servicing 0120 489 203, -207, -211, -375, -379, -381, -449



135007

Replacing 1125 824 544
Servicing 0120 489 012, -013, -076, -861, -862, -863, -864, -865, -866, -964, -965



134872

Replacing 1125 825 036
Servicing 0120 469 549, -679, -849



134908

Replacing 1125 824 344
Servicing 0120 488 170, -171, 0120 489 112, -113, -493, -494, -780, -781



135156

Replacing 1125 825 104
Servicing 0120 469 749, -798

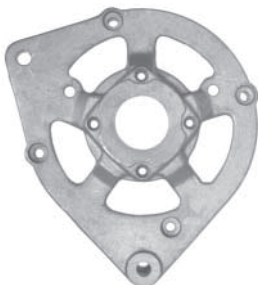

134874

Replacing 1125 824 350
Servicing 0120 488 350



135006

Replacing 1125 824 530
Servicing 0120 489 232, -233, -234, -300, -301



135159

Replacing 1125 824 284
Servicing 0120 489 003, -004, -005, -007, -058, -063, -080, -186, -614, -615, -660, -688, -712, -714, -737, -758, -772, -785, -857, -867, -972, -973, -975, -976, -977, -978, -979

Replacing BOSCH



135160

Replacing 1125 824 441, -534
Servicing 0120 488 133, -136,
 0120 489 324, -323



135555

Replacing 1125 824 141, -524, -590
Servicing 0120 400 723,
 0120 488 138, -224, -292, 0120 489 022,
 -023, -294, -506, -507, -707, -710, -730,
 6033 GB2 009



135779

Replacing 1125 824 613
Servicing 0120 488 100, -101, -162, -168,
 -169, -170, -171, -172, -173, -186, -187,
 -192, -193, -202, -204



135197

Replacing 1125 824 316
Servicing 0120 489 230, -684, -827



135612

Replacing 1125 824 416, -551
Servicing 0120 489 195, -196, -197,
 -364, -365, -366, -369, -370, -438, -445,
 -448, -499



135810

Replacing 1125 823 082, -085
Servicing 0120 335 006, -007
Mounting bushing: Cargo 139592



135198

Replacing 1125 825 016
Servicing 0120 469 661, -662, -808, -809

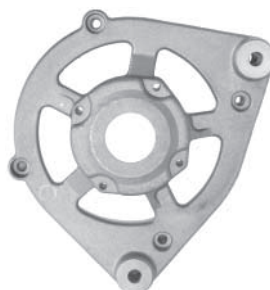

135778

Replacing 1125 825 047
Servicing 0120 469 008, -585

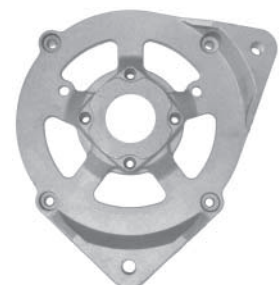

135813

Replacing 1125 825 040
Servicing 0120 469 547, -559, -566, -655,
 -656, -660, -661, -713, -754, -781, -899

Replacing BOSCH



135898

Replacing 1125 825 043
Servicing 0120 469 569, -643, -762, -900



135934

Replacing 1125 824 610
Servicing 0120 488 164, -165, -190, -191, -255



135986

Replacing 1125 825 327, -347
Servicing 0120 465 010, -011, -020, -021, -026, -027, -028, 0123 505 005, -011, -012, 0123 510 001, -005, -008, -009, -029, -030, 0123 515 013, -014, -028, 0123 540 001



135905

Replacing 1125 824 293
Servicing 0120 488 139, -152, -221, -254, -287, 0120 489 021, -136, -137, -171, -272, -273, -318, -319, -424, -498



135947

Replacing 9121 145 804
Servicing 0120 488 000, -001, -008, -009, -012



135987

Replacing 1125 825 115
Servicing 0120 469 784, -785, -786, -787, -788, -789, -793, -992, -993, -996, -997



135908

Replacing 1125 825 279
Servicing 0120 469 021, -715, -716, -722, -723, -724, -725, -726, -774, -929, -930



135965

Replacing 9121 140 470
Servicing 0120 489 393, -394



135988

Replacing 1125 825 069
Servicing 0120 469 034, -035, -100 -107, -108, -109, -110, -111, -112, -113, -114, -646, -647, -666, -710, -836, -860, -861, -875, -892, -979, -980, -981, 6033 GB3 009

Replacing BOSCH



135991

Replacing 1125 824 601, -671, -953
Servicing 0120 485 015, 0123 310 016



136002

Replacing 1125 827 013
Servicing 0120 689 520, -522, -527, -530, -533, -534, -535, -540, -541



136054

Replacing 1125 825 133
Servicing 0120 469 015, -790, -822, -823, -832, -839, -888, -889, -908, -953, -975, -998



135995

Replacing 9121 145 828
Servicing 9120 144 287, -288



136029

Replacing 1125 825 130
Servicing 0120 468 022, -023, -024, -034, -044, -052, -056, -068, -069, -079, -089, -106, -108



136124

Replacing 1125 825 081, -217
Servicing 0120 469 588, -589, -590, -591, -611, -642, -644, -844, -944, -945, -949, -950



136001

Replacing 1125 827 003
Servicing 0120 689 503, -508, -512, -513



136030

Replacing 1125 825 206
Servicing 0120 468 042, -043



136292

Replacing 1125 824 333
Servicing 0120 489 032, -221, -726
Mounting bushing: Cargo 233569

Replacing BOSCH



136294

Replacing 1125 824 426
Servicing 0120 489 251, -252, -292



136390

Replacing 9121 145 861
Servicing 9120 144 302, -303, 9120 334 310, -319



136439

Replacing 1125 824 343, -592
Servicing 0120 489 024, -146, -149, -150, -168, -397, -398, -748, -749, -751, -829, -935, -936



136309

Replacing 1125 824 413
Servicing 0120 489 189, -190, -358

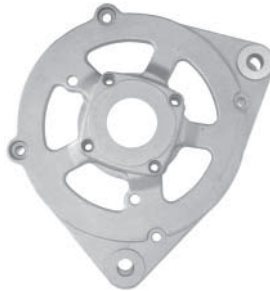

136417

Replacing 1125 825 168
Servicing 0120 469 744, -745, -746, -852, -854, -855, -856, -857, -884, -894, -896, -897, -905, -925, -926, -927, -928, -943, -946, -947, -948, -955, -956



136441

Replacing 1125 825 314
Servicing 0120 468 093

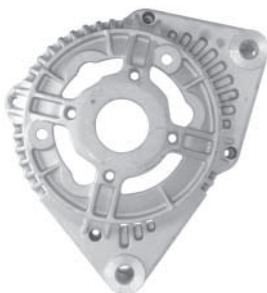

136361

Replacing 1125 824 665
Servicing 0120 485 011, -012, -022, -025, -026, 0123 310 004, -005, 0123 315 005, 0123 320 004, -010, 0123 335 002, -003, 0123 340 004



136420

Replacing 9121 145 802
Servicing 9120 144 600, -601, -602, -603, -604, -606, -608, -609, -615, -616, -618, -619, -621, -622, -624



136473

Replacing 1125 825 034, -058, -074, -077
Servicing 0120 469 538, -539, -560, -561, -593, -617, -618, -619, -782, -783, -794, -795, -804, -805, -806, 9120 690 253

Replacing BOSCH



136715

Replacing 1125 824 434
Servicing 0120 489 346, -347, -389, -390, -408



136781

Replacing 1125 825 346, -260
Servicing 0120 468 037, -114

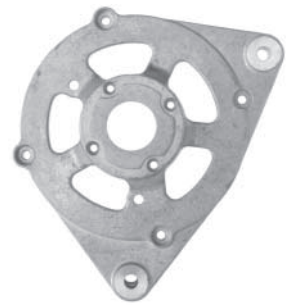

136817

Replacing 1125 825 123
Servicing 0120 469 775, -776, -989, -990



136774

Replacing 1125 824 340
Servicing 0120 489 731



136782

Replacing 1125 825 090
Servicing 0120 469 001, -013, -686, -687, -895, -982, 6033 GB3 008

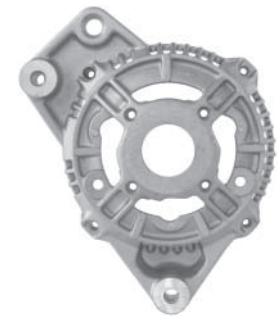

136821

Replacing 1125 824 668
Servicing 0123 335 001

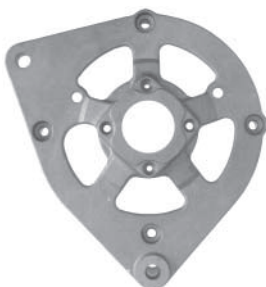

136775

Replacing 1125 824 411, -492
Servicing 0120 488 118, -119



136799

Replacing 1125 824 398
Servicing 0120 489 152, -153, -155, -212, -219, -338



136906

Replacing 9121 141 062
Servicing 9120 144 240, -241

Replacing BOSCH



136913

Replacing 1125 824 676, -699
Servicing 0120 485 034, 0123 114 005, 0123 310 002, 0123 315 001

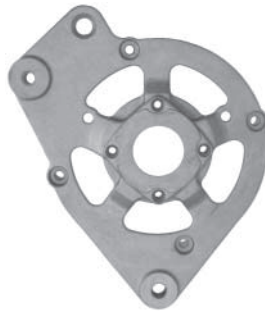

136991

Replacing 1125 824 567
Servicing 0120 488 144, -145



137019

Replacing 1125 824 406
Servicing 0120 489 173, -174, -344



136989

Replacing 1125 824 307
Servicing 0120 489 225, -231, -284, -725, -757
Mounting bushing: Cargo 233569



136996

Replacing 1125 825 286
Servicing 0120 468 084, -085, -119



137022

Replacing 1125 824 194
Servicing 0120 400 645, -666, -732, -805



136990

Replacing 1125 824 591
Servicing 0120 489 756



136999

Replacing 1125 825 245
Servicing 0120 469 641, -667, -799, -800, -801, -802, -921, -922, -923, -924, -988



137086

Replacing 1125 824 666
Servicing 0120 485 047

Replacing BOSCH



137088

Replacing 1125 825 244
Servicing 0120 469 575, -576, -577, -578, -650, -651, -818, -819, -820, -821



137138

Replacing 1125 823 074
Servicing 0120 335 539, -543, -544, -545



137180

Replacing 1125 824 428, -573
Servicing 0120 488 130, -131, -285, 0120 489 295, -297



137111

Replacing 1125 824 667
Servicing 0120 485 029, 0123 310 014



137139

Replacing 1125 824 969
Servicing 0123 310 022, 1123 320 030



137235

Replacing 1125 825 318
Servicing 0120 469 011



137113

Replacing 1125 825 340
Servicing 0123 500 004, -006, 0123 510 017, 0123 545 001



137140

Replacing 1125 825 255
Servicing 1120 468 029, -101



137389

Replacing 1125 824 165
Servicing 0120 400 740, -741, -832, -839, -850, 120 488 157, 0120 489 115, -572, -628, -722, -837, -910, 9120 144 016, -204

Replacing BOSCH



137391

Replacing 1125 824 473
Servicing 0120 488 124, -166, -167, -200, -201, 0120 489 419, -489



137411

Replacing 1125 823 019
Servicing 0120 300 535, -562, -575, -577, -578, -580, -589, 0120 339 511, -512, -513, -532



137477

Replacing 1125 823 507
Servicing 0123 115 011, 9120 336 000



137392

Replacing 1125 824 569
Servicing 0120 488 183, -184, -219, -220



137469

Replacing 1125 824 615
Servicing 0120 485 050



137498

Replacing 9121 335 527
Servicing 9120 334 631, -632



137410

Replacing 1125 825 230
Servicing 0120 468 065, -094, -116, -124, -129, -130



137475

Replacing 1125 824 477
Servicing 0120 488 146, -147, -148



137499

Replacing 1125 824 955
Servicing 0123 310 017, -030

Replacing BOSCH



137500

Replacing 1125 824 965
 Servicing 0123 320 014



137503

Replacing 1125 825 338
 Servicing 0123 505 001, -202



137597

Replacing 1125 825 215
 Servicing 0120 468 057, -058, -059, -060



137501

Replacing 1125 824 979
 Servicing 0123 310 023



137504

Replacing 1125 825 341
 Servicing 0123 500 005, 0123 505 015,
 0123 545 002



137598

Replacing 1125 825 264
 Servicing 0120 469 521



137502

Replacing 1125 825 307
 Servicing 0120 465 031

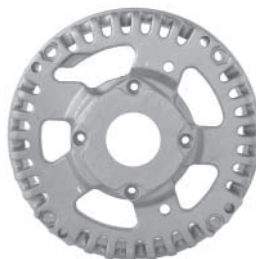

137505

Replacing 1125 825 349
 Servicing 0123 468 125



137599

Replacing 9121 145 827
 Servicing 9120 144 285, -286

Replacing BOSCH



137817
 Replacing 1125 827 009
 Servicing 0120 689 515, -532



138018
 Replacing 1125 824 652
 Servicing 0123 315 004



138021
 Replacing 1125 824 696
 Servicing 0123 310 006



138015
 Replacing 1125 823 042
 Servicing 0120 300 567, -576, -585,
 0120 339 521, -536, -537



138019
 Replacing 1125 824 682
 Servicing 0123 325 002

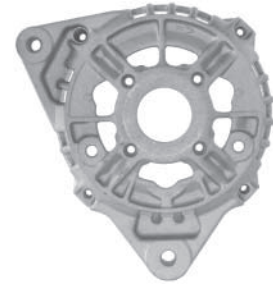

138022
 Replacing 1125 824 726
 Servicing 0120 320 050



138017
 Replacing 1125 824 579
 Servicing 0120 489 156, -625, -626



138020
 Replacing 1125 824 694
 Servicing 0123 320 011, 0123 335 004,
 -005



138023
 Replacing 1125 824 959
 Servicing 0123 310 010, -011, -012, -013

Replacing BOSCH

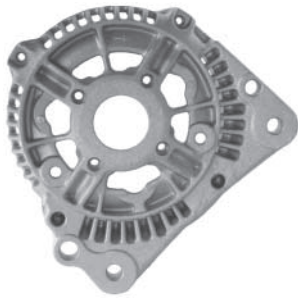

138024

Replacing 1125 824 697, -972, -986
Servicing 0123 315 004



138030

Replacing 1125 825 213, -343
Servicing 0120 468 053, -107, -113, -115, -118



138033

Replacing 1125 825 519
Servicing 0123 520 002

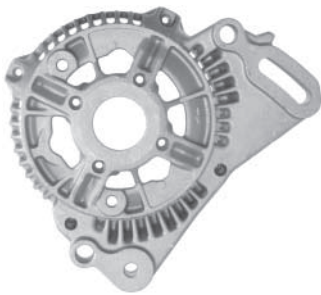

138025

Replacing 1125 824 974
Servicing 0120 310 020, 0120 320 006



138031

Replacing 1125 825 337
Servicing 0123 505 007, -008, -009, 0123 510 013, -014, -015, -028, -033



138181

Replacing 1125 824 466, -575
Servicing 0120 484 011, 0120 488 205, -293, 0120 489 475



138029

Replacing 1125 825 172
Servicing 0120 468 030, -031, -032, -033, -048, -049, -071, -072, -099, -100

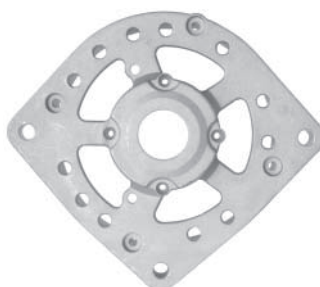

138032

Replacing 1125 825 354
Servicing 0120 468 131



138199

Replacing 1125 825 110
Servicing 0120 469 020, -742, -743, -931, -932, -933, -934

Replacing BOSCH



138230

Replacing 1125 825 510, -521
Servicing 0123 505 013, 0123 510 006, -007, -026, -027, -029, -030, -031, -032, -034, -037, -048, -053, -054, -056, -095, -099, 0123 515 003, -008, -009, -011, -017, -018, -020, -021



138785

Replacing 1125 824 555
Servicing 0120 484 015, -021, 0120 488 134, -233



139024

Replacing 1125 827 021
Servicing 0120 689 526, -531, -543, -545, -548, -549, -552, -557, -561, -566



138272

Replacing 1125 825 267
Servicing 0120 469 005, -006, -907, -912, -967, -969, -974, -985



138994

Replacing 1125 824 963
Servicing 0123 315 007, -020



139036

Replacing 1125 825 024, -174
Servicing 0120 469 502, -519, -520, -534, -541, -542, -543, -545, -546, -548, -552, -553, -554, -555, -556, -557, -558, -721, -773



138273

Replacing 1125 827 006
Servicing 0120 689 505, -511, -514, -518



139000

Replacing 1125 825 309, -500
Servicing 0123 214 002, 0123 515 002, -010



139256

Replacing 1125 824 626
Servicing 0120 489 249

Replacing BOSCH



139258

Replacing 1125 825 275
Servicing 0120 450 023, -024, -025, -026, -027, -028, -029, -030, -031



139301

Replacing 1125 824 975
Servicing 0123 315 013, 0123 320 012, 0123 325 010



139745

Replacing 9121 145 815
Servicing 9120 144 277, -278, -268



139264

Replacing 1125 823 077, -100
Servicing 0120 335 012, 123 110 004



139354

Replacing 1125 825 179
Servicing 0120 469 674, -675, -706, -707, -740, -741, -904, -976, -977



139909

Replacing 1125 823 509
Servicing 0123 100 003, 0123 110 006, -008

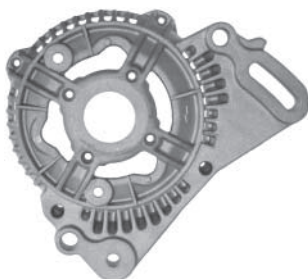

139279

Replacing 1125 824 677, -700
Servicing 0120 485 036, 0123 320 002, 0123 340 002

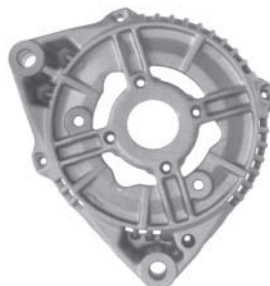

139355

Replacing 1125 825 525
Servicing 0123 500 007, -008, -009, 0123 505 003, -004, 0123 510 003, -020, -043, -052, -062, -064, -069, -093



139916

Replacing F00M 116 203
Servicing 0124 225 002, -009, -024, -025

Replacing BOSCH



139918

Replacing F00M 126 207
Servicing 0124 315 001, -002, -003, -004, -005, -006, -011, -012, -013, 0124 325 001, -002, -003, -004, -011, -012, -013, -014, -018, -021, -022



139972

Replacing 1125 824 952
Servicing 0123 315 008, -015, -017, -018, -019



139993

Replacing 1125 824 967
Servicing 0123 310 015



139922

Replacing F00M 136 213
Servicing 0124 515 017, -018, -019, -054



139973

Replacing 1125 824 977
Servicing 0123 315 016, -021



230009

Replacing F00M 136 205, -218
Servicing 0124 515 010, -011, -012, -013, -020, -021, -022, -026, -035, -038, -039, -057, -090



139951

Replacing 1125 825 222, -305, -325, -507
Servicing 0120 465 003, -015, -016, -017, 0123 500 001, 0123 510 004, -012, -018, -021, -022, -023, -038, -039, -040, -049, -050, -051, -057, -058, -059, -060, -066, -067, -072, -074, -075, -080



139992

Replacing 1125 825 261
Servicing 0120 469 938, -939



230117

Replacing 9121 335 863
Servicing 9120 334 625, -626, -635

Replacing BOSCH



230172

Replacing 1125 825 358
Servicing 0120 468 135, -144,
 6033 GB3 021



230284

Replacing 1125 825 527
Servicing 0123 510 068, -079, -081, -100,
 -101, -102, 0123 520 006, -007, -008,
 -010, -011, -012, -013, -015, -017



230450

Replacing 1125 824 980
Servicing 1123 310 029



230176

Replacing F00M 126 219
Servicing 0124 325 009



230316

Replacing 1125 824 108
Servicing 0120 400 634, -635, -637, -639,
 -640, -641, -642, -647, -648, -652, -673,
 -674, -679, -680, -685, -688, -689, -690,
 -691, -694, -697, -698, -715, -736, -788,
 -789, -790, -791, -798, -799, -845, -846

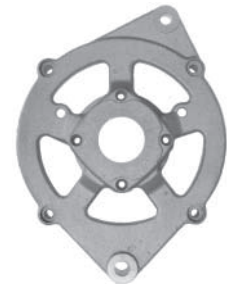

230509

Replacing 1125 825 372
Servicing 0120 468 140, -154



230236

Replacing 1125 825 538
Servicing 0123 510 082, -107, -108,
 123 520 023, -025



230449

Replacing 1125 824 484
Servicing 0120 488 149, -150, -178, -182,
 -242 -243



230612

Replacing 1125 825 141
Servicing 0120 469 829, -830, -878 -879,
 -913, -914, -918, -919

Replacing BOSCH



230618

Replacing 9121 145 813
Servicing 0120 488 002, -003, -004, -005

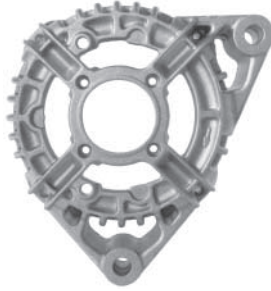

230737

Replacing F00M 126 203
Servicing 0124 415 001, -005

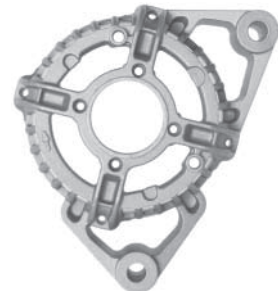

231016

Replacing F00M 116 205
Servicing 0124 225 001, -004, -022, -023
Bearing: Cargo 140093



230692

Replacing 1125 824 669
Servicing 0120 485 030



230751

Replacing 1125 824 338, -625
Servicing 0120 489 126, -127, -187, -188, -218, -738, -739



231067

Replacing 1125 825 185
Servicing 0120 469 882, -883, -915, -916, -935, -994, -995
Bearing: Cargo 140093



230711

Replacing 1125 825 352
Servicing 0120 468 127, -128, -134



230972

Replacing F00M 116 225
Servicing 0124 225 010, -011
Bearing: Cargo 140093



231124

Replacing 1125 824 288
Servicing 0120 489 036, -037, -191, -473, -474, -619
Bearing: Cargo 140087

Replacing BOSCH



231125

Replacing 1125 824 479
Servicing 0120 488 142, -143, -490, -491, -492
Bearing: Cargo 140093

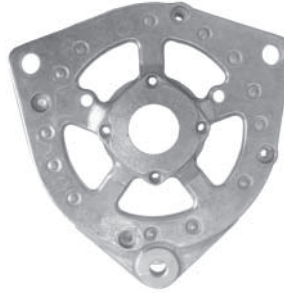

231171

Replacing 1125 825 365
Servicing 0120 469 115, -116, 6033 G3B 022, 6033 GB3 019, -022, -027
Bearing: Cargo 140569



231281

Replacing 2125 827 062
Servicing 0120 689 562
Bearing: Cargo 140707



231128

Replacing F00M 126 215
Servicing 0124 325 008, -010
Bearing: Cargo 140093



231247

Replacing 1125 825 303
Servicing 0120 469 682, -683, -684, -685, -881
Bearing: Cargo 140093

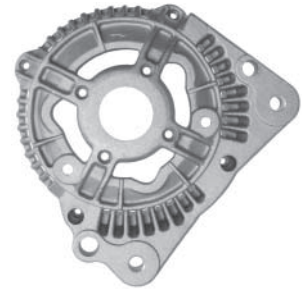

231545

Replacing 1125 824 660, -662, -698
Servicing 0120 485 039, -043, -044, -046, 0123 310 001, -003, -007, 0123 315 002, -006, 0123 340 005
Bearing: Cargo 140093



231157

Replacing 1125 827 020
Servicing 0120 689 516, -524, -538, -539, -550
Bearing: Cargo 140644



231253

Replacing F00M 126 217
Servicing 0124 415 006
Bearing: Cargo 140093



231562

Replacing 1125 824 176
Servicing 0120 400 750, -751, -767, -768, -889, -890, 0120 489 038, -039, -045, -533, -534, -543, -544, -607, -608, -611, -644, -645, -646, -647, -648
Bearing: Cargo 140087

Replacing BOSCH



231586

Replacing 1125 823 097
Servicing 0123 100 001, -002,
 0123 110 005, 0123 120 001
Bearing: Cargo 140093



231701

Replacing 1125 825 154
Servicing 0120 468 028, -054, -055, -136,
 -147
Bearing: Cargo 140917



232479

Replacing 1125 827 022
Servicing 0120 689 542, -546, -572
Bearing: Cargo 140707



231595

Replacing 9121 335 540
Servicing 0120 468 143, -145,
 6033 GB3 010, -023
Bearing: Cargo 140569



231760

Replacing F00M 116 209
Servicing 0124 215 001, -002, -003,
 0124 225 016
Bearing: Cargo 140093

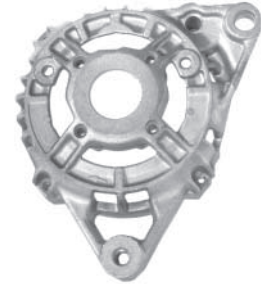

233336

Replacing 1125 824 998
Servicing 0123 315 500, -502, -503,
 0123 320 066
Bearing: Cargo 140263



231598

Replacing 1125 824 202
Servicing 0120 400 786, -787, -847, -848
Bearing: Cargo 140087



231778

Replacing F00M 136 209, -291
Servicing 0124 515 005, -006, -008, -043,
 -049, -080, -081, -085, 0124 525 012,
 -013, -018, -021, -022, -030, -031
Bearing: Cargo 140093



233466

Replacing F00M 126 223
Servicing 0124 415 002
Bearing: Cargo 140093

Replacing BOSCH

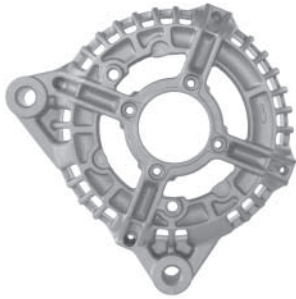

233468

Replacing F00M 136 220
Servicing 0124 615 002
Bearing: Cargo 140093



233556

Replacing 1125 825 151
Servicing 0120 469 870, -871, -874,
 -962, -970
Bearing: Cargo 140093



233647

Replacing 1125 825 368
Servicing 0120 469 101, 6033 GB3 047
Bearing: Cargo 140569

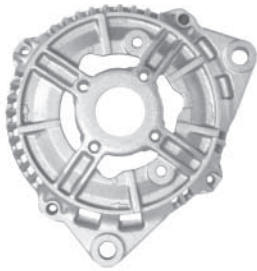

233478

Replacing 1125 825 334
Servicing 0123 212 001
Bearing: Cargo 140093



233560

Replacing F00M 126 229
Servicing 0124 415 011, -012
Bearing: Cargo 140093



233662

Replacing 1125 824 684
Servicing 0123 325 003, -013
Bearing: Cargo 140093



233509

Replacing F00M 126 239
Servicing 0124 315 019, -027
Bearing: Cargo 140093



233567

Replacing 9121 335 528
Servicing 6033 GB3 059, 6033 GB5 007,
 -009, 9120 335 000, -001, -002
Bearing: Cargo 140093



233724

Replacing 1125 824 728
Servicing 0123 320 051, -065
Bearing: Cargo 140263

Replacing BOSCH



233727

Replacing F00M 126 231, -273
Servicing 0124 325 024, -031
Bearing: Cargo 140093

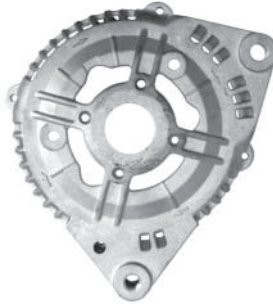

234182

Replacing 1125 825 326
Servicing 0120 465 007, -008, -022, -023, 0123 510 061
Bearing: Cargo 140093

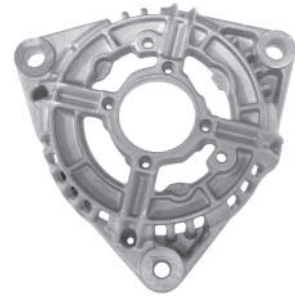

234526

Replacing 1125 825 547
Servicing 0123 525 501
Bearing: Cargo 140263

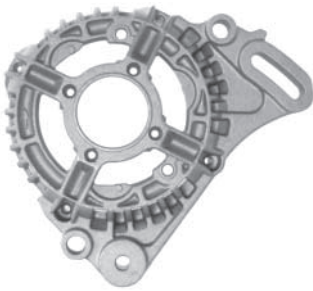

233939

Replacing F00M 126 221, -297
Servicing 0124 315 007, -008, 0124 325 015, -016, -033, -051, -057, -075, -106
Bearing: Cargo 140093



234379

Replacing 1125 825 540
Servicing 0123 520 500, 0123 525 500, -502, -503
Bearing: Cargo 140263
Bearing plate: Cargo 135608



234529

Replacing F00M 126 275
Servicing 0124 415 007, -013, -014
Bearing: Cargo 140093



234031

Replacing F00M 126 225
Servicing 0124 320 001, -002, 0124 325 052
Bearing: Cargo 140093

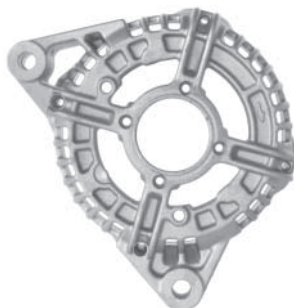

234425

Replacing F00M 136 217, -305
Servicing 0124 515 024, -025, -027, -028, -034, -040, -058, 0124 525 008
Bearing: Cargo 140093

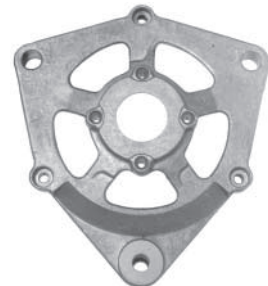

234560

Replacing 1125 824 145
Servicing 0120 400 699, -700, -773, -774, -874, -881, -882, -891, -904, -907, -934 9120 080 020, -054
Bearing: Cargo 140093

Replacing BOSCH



235023

Replacing F00M 136 226
Servicing 0124 510 001, 0124 515 044,
 0124 555 005
Bearing: Cargo 141233



235322

Replacing 1125 824 734
Servicing 0123 325 500
Bearing: Cargo 140263



Brackets S.R.E.



132214

Replacing 1125 884 398
Servicing 0120 489 510, -536, -551, -568,
 -587, -588, -589, -590, -592, -593, -617



235042

Replacing F00M 136 244
Servicing 0111 548 602, 0121 540 402,
 0121 546 802, 0124 222 002,
 0124 555 001, -003, -004, -013, -014, -022
Bearing: Cargo 140263



236200

Replacing 1125 824 446
Servicing 0120 489 334, -35, -36, -37
Bearing: Cargo 140093



132215

Replacing 1125 884 390
Servicing 0120 400 857, -859,
 0120 489 061, -300, -301, -302, -480,
 -527, -528, -556, -623, -683, -786, -828,
 -878, -910, -912, -918, -931, -932, -933,
 9120 144 270



235227

Replacing F00M 126 265
Servicing 0124 415 016, -030, -032
Bearing: Cargo 141233



239227

Replacing 1125 824 698, -662
Servicing 0133 310 001, -003, -007, 0123
 315 002, 0120 485 045
Bearing: Cargo 140093
Mounting bushing: Cargo 137575 x 2



134081

Replacing 1125 884 294
Servicing 0120 400 909, 0120 489 550,
 -904

Replacing BOSCH



134125

Replacing 1125 884 479
Servicing 0120 489 047, -048, -088, -091, -103, -176, -245, -267, -287, -288, -290, -291, -314, -345, -403, -426, -957, -959
Mounting bushing: Cargo 134774



134133

Replacing 1125 885 060, -261
Servicing 0120 469 034, -035, -646, -647, -861, -875, -892
Mounting bushing: Cargo 137408



134309

Replacing 1125 884 493
Servicing 0120 484 001, -011, 0120 488 134, -205, 0120 489 365, -366, -370, -371, -375, -379, -381, -425, -430, -431, -438, -441, -445, -448, -449



134127

Replacing 1125 884 484
Servicing 0120 489 316



134135

Replacing 1125 884 374
Servicing 0120 489 127, -188, -218, -739



134315

Replacing 1125 884 494
Servicing 0120 489 363, -368, -373, -377, -380, -383, -428, -433, -437, -440, -443, -444, -447, -496



134129

Replacing 1125 885 019, -143
Servicing 0120 469 008, -019, -024, -025, -030, -038, -039, -518, -519, -520, -521, -526, -532, -540, -562, -569, -580, -585, -592, -630, -643, -652, -653, -692, -753, -761, -762, -763, -772, -773, -807, -843

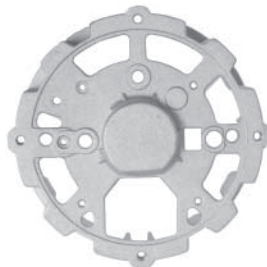

134286

Replacing 1125 884 529
Servicing 0120 489 192, -230, -303, -643, -684, -702, -731, -827, -944

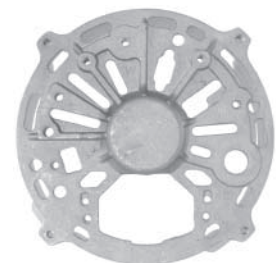

134316

Replacing 1125 885 070
Servicing 0120 469 672, -697, -698, -699, -700, -702, -703, -704, -705, -707, -708, -714, -716, -718, -720

Replacing BOSCH



134322

Replacing 9122 145 839
Servicing 9120 144 279, -280



134679

Replacing 1125 884 350
Servicing 0120 400 943, 0120 489 018, -019, -020, -106, -144, -145, -146, -147, -151, -335, -337, -741, -743, -762, -765, -770, -822, -838, -921, -984, -985
Mounting bushing: Cargo 137461

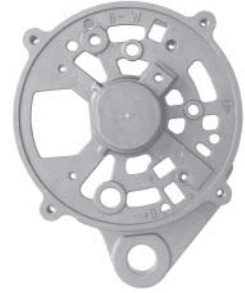

134873

Replacing 1125 885 036
Servicing 0120 469 010, -022, -023, -026, -027, -031, -549, -634, -673, -849, -890, -978, -999
Mounting bushing: Cargo 137343



134337

Replacing 1125 884 388
Servicing 0120 489 129, -263, -348, -400, -401, -943



134680

Replacing 1125 884 160, -303, -306, -420
Servicing 0120 400 743, -783, -853, -855, 0120 489 044, -046, -066, -109, -111, -115, -117, -119, -121, -122, -124, -125, -139, -285, -297, -309, -466, -481, -534, -538, -544, -586, -611, -626, -630, -632, -636



135148

Replacing 1125 885 021, -037
Servicing 0120 450 009, 0120 469 563, -564, -567, -568, -608, -609, -628, -664, -665, -668, -669, -670, -680, -681, -791, -792



134400

Replacing 1125 883 056
Servicing 0120 300 552, -562, -575, -576, -577, -578, -579, -580, -585, -586, -589, -590, 0120 339 511, -512, -513, -514, -521, -531, -532, -535, -536, -537, -538,
O-ring: Cargo 135357



134871

Replacing 1125 884 359, -527
Servicing 0120 488 133, -136, -153, 0120 489 023, -032, -033, -034, -035, -055, -221, -231, -284, -388, -707, -710, -723, -724, -725, -726, -727, -728, -730, -733, -757, -886, -902, -994, -995, -996



135149

Replacing 1125 884 555, -557
Servicing 0120 489 469, -470, -476

Replacing BOSCH

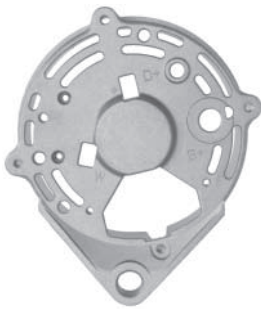

135151

Replacing 1125 884 539
Servicing 0120 488 200, -201
Mounting bushing: Cargo 134774

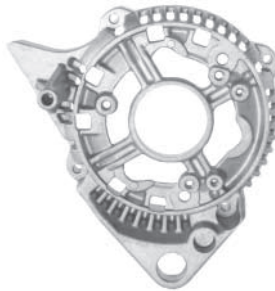

135811

Replacing 1125 884 678
Servicing 0120 485 034, -035,
 0123 114 005, 0123 310 002, -087,
 0123 315 001
Mounting bushing: Cargo 137575



135994

Replacing 1125 884 481
Servicing 0120 489 310, -311, -312, -474



135556

Replacing 1125 885 157
Servicing 0120 469 014, -522, -523, -749,
 -798



135891

Replacing 1125 885 033, -034, -035
Servicing 0120 450 003, -004,
 0120 469 500, -501, -502, -503, -504,
 -505, -510, -511, -515, -524, -525, -528,
 -533, -534, -535, -537, -541, -542, -543,
 -544, -545, -546, -547, -548, -551, -552



136003

Replacing 1125 887 003
Servicing 0120 689 503, -506, -508, -512,
 -513, -515, -532



135780

Replacing 1125 884 413
Servicing 0120 484 017, -019, -020,
 0120 488 162, -164, -165, -168, -169,
 -170, -171, -172, -173, -186, -187, -190,
 -191, -192, -193, -202, -204, -255



135993

Replacing 1125 884 385
Servicing 0120 489 024, -025, -026, -078,
 -079, -149, -150, -162, -168, -184, -298,
 -299, -397, -398, -748, -749, -750, -751,
 -829, -897, -898, -899, -930, -935, -936



136006

Replacing 1125 887 013
Servicing 0120 689 520, -523, -526, -530,
 -533, -534, -535, -546

Replacing BOSCH



136021

Replacing 1125 885 052, -058
Servicing 0120 469 581,
 -582, -586, -587, -588, -589, -590, -591,
 -594, -595, -600, -603, -611, -618, -619,
 -620, -641, -642, -644, -645, -648, -649,
 -667, -694, -695, -794, -795, -804, -805



136125

Replacing 1125 885 038
Servicing 0120 469 512, -513, -516, -517,
 -530, -531, -566, -570, -571, -572, -573,
 -574, -676, -677, -754
Mounting bushing: Cargo 137379



136362

Replacing 1125 884 669
Servicing 0120 485 011, -012, -022, -025,
 -026, 0123 310 004, -005, -008, -026,
 -028, 0123 315 005, 0123 320 004, -010,
 -011, -020, -022, -023, 0123 335 002,
 -003, -005, -006, -008, 0123 340 004



136043

Replacing 1125 885 114, -175, -226
Servicing 0120 468 007, -008, -013, -014,
 -095, -096, -097, -098
Mounting bushing: Cargo 137379



136354

Replacing 1125 884 559
Servicing 0120 488 146, -147, -148, -149,
 -150, -178, -179, -180, -181, -243
Mounting bushing: Cargo 134774



136375

Replacing 1125 885 105
Servicing 0120 469 784, -785, -786, -787,
 -788, -789, -793, -992, -993, -997, -998



136097

Replacing 1125 885 077
Servicing 0120 469 015, -689, -690, -709,
 -790, -822, -823, -831, -832, -839, -888,
 -889, -903, -908, -953, -975, -998
Mounting bushing: Cargo 137262



136355

Replacing 1125 885 082
Servicing 0120 469 744, -745, -746, -857,
 -894, -896, -897, -925, -926, -927, -928,
 -943, -946, -947, -948



136384

Replacing 1125 885 067
Servicing 0120 469 002, -011, -012, -020,
 -021, -722, -723, -724, -725, -726, -727,
 -728, -729, -730, -731, -732, -733, -734,
 -735, -736, -737, -738, -739, -740, -741,
 -742, -743, -758, -759, -768, -774, -777

Replacing BOSCH



136391

Replacing 9122 145 905
Servicing 9120 144 302, -303,
 9120 334 310
Mounting bushing: Cargo 231560



136478

Replacing 9122 145 862
Servicing 9120 144 232, -233, -274, -277,
 -278

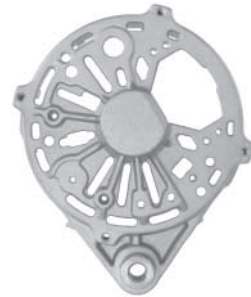

136778

Replacing 1125 885 118
Servicing 0120 469 017, -018, -019, -020,
 -022, -023, -024, -025, -026, -027, -034,
 -044, -052, -056, -068, -069, -070, -079,
 -089, -091, -092, -106, -108, -109, -112
Mounting bushing: Cargo 137379



136392

Replacing 1125 885 146
Servicing 0120 469 864, -865



136776

Replacing 1125 884 499
Servicing 0120 489 360, -361
Mounting bushing: Cargo 137262



136809

Replacing 1125 885 217, -235
Servicing 0120 465 003, -004, -013, -014,
 -015, -016, -017, -018



136440

Replacing 1125 885 230
Servicing 0120 468 093



136777

Replacing 1125 885 187
Servicing 0120 469 920
Mounting bushing: Cargo 137400



136918

Replacing 1125 884 487
Servicing 0120 489 346, -347, -389, -390,
 -408

Replacing BOSCH



136920

Replacing 1125 884 461
Servicing 0120 489 251, -252, -292



137087

Replacing 1125 884 670
Servicing 0120 485 047



137098

Replacing 1125 884 735, -923
Servicing 0120 315 500, -502, -503, 0123 310 022, -043, -044, -047, -50, 0123 320 016, -028, -052, -053, -054
Mounting bushing: Cargo 139245



136921

Replacing 1125 885 140
Servicing 0120 469 939, -938



137096

Replacing 1125 884 631
Servicing 0123 315 004
Mounting bushing: Cargo 137379



137100

Replacing 1125 885 224
Servicing 0120 469 775, -776, -989, -990
Mounting bushing: Cargo 137379



136997

Replacing 1125 885 072
Servicing 0120 469 032, -655, -656, -657, -658, -659, -660, -661, -662, -688, -713, -747, -748, -781, -899, -958
Mounting bushing: Cargo 137379



137097

Replacing 1125 884 911
Servicing 0123 310 017, -030
Mounting bushing: Cargo 138086

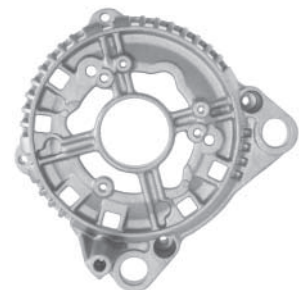

137101

Replacing 1125 885 237
Servicing 0120 465 009, -010, -011, -020, -021, -026, -027, -028, 0123 505 005, -010, -011, -012, 0123 510 001, -005, -008, -009
Mounting bushing: Cargo 137575

Replacing BOSCH



137102

Replacing 1125 885 238
Servicing 0120 465 006, -012, -029,
 0123 500 004, -006, 0123 510 017,
 0123 545 001, -003
Mounting bushing: Cargo 138086



137105

Replacing 1125 885 240
Servicing 0123 505 001, -002
Mounting bushing: Cargo 138091



137116

Replacing 9121 335 927
Servicing 9120 144 605, -606



137103

Replacing 1125 885 520
Servicing 0120 465 031
Mounting bushing: Cargo 138087



137108

Replacing 1125 884 917
Servicing 0123 320 014
Mounting bushing: Cargo 134774



137311

Replacing 1125 885 213, -312, -615
Servicing 0120 469 004, -006, -007, -907,
 -967, -968, -969, -973, -984, -985
Mounting bushing: Cargo 137262



137104

Replacing 1125 885 211
Servicing 0120 468 061, -062, -063, -064,
 -075, -076, -077, -078, -102, -103, -104,
 -105, -110, -111
Mounting bushing: Cargo 137262



137112

Replacing 1125 884 671
Servicing 0120 485 029, 0123 310 014
Mounting bushing: Cargo 134774



137316

Replacing 1125 883 080, -084
Servicing 0120 335 010, 0123 100 001,
 -002, 0123 110 005, 0123 120 001
Mounting bushing: Cargo 137575

Replacing BOSCH



137384

Replacing 1125 885 243
Servicing 0123 505 003, -004,
 0123 510 020
Mounting bushing: Cargo 138091 x 2



137596

Replacing 1125 884 598
Servicing 0120 488 137, -269, -270,
 0120 489 226, -227



137698

Replacing 9122 145 806
Servicing 0120 488 000, -001, -008, -009,
 -012

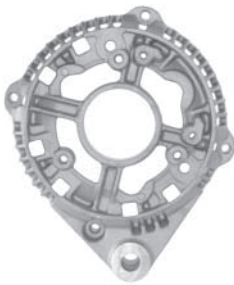

137472

Replacing 1125 884 584
Servicing 0120 485 050

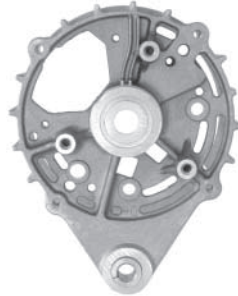

137600

Replacing 9122 335 915
Servicing 9120 334 625, -626, -635

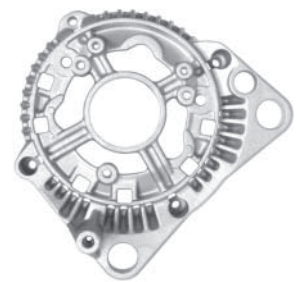

137987

Replacing 1125 884 665
Servicing 0123 320 001, -003, -005, -033,
 -048, 0123 340 001, -003, -005,
 0120 485 020, -023, -038, -039
Mounting bushing: Cargo 137575 x 2



137496

Replacing 9121 335 886
Servicing 9120 334 631, -632

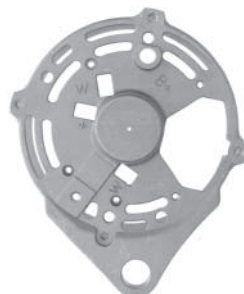

137601

Replacing 9122 144 843
Servicing 9120 144 285, -286

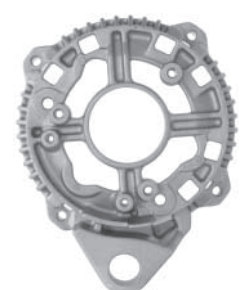

137988

Replacing 1125 884 686
Servicing 0123 325 002
Mounting bushing: Cargo 138090

Replacing BOSCH

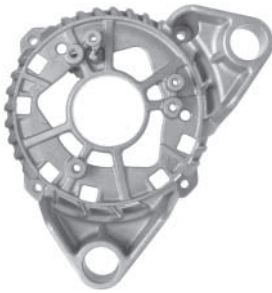

137989

Replacing 1125 884 700
Servicing 0123 310 006, 0123 320 012
Mounting bushing: Cargo 138087 x 2

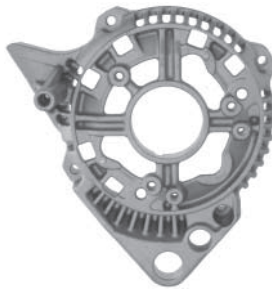

137993

Replacing 1125 884 927
Servicing 0123 310 020, 0123 320 006
Mounting bushing: Cargo 137575



138001

Replacing 1125 885 197, -236, -532, -533
Servicing 0120 465 007 -008, -023,
 0123 505 007, -008, -009, 0123 510 013,
 -014, -015, -028, -033, -041, -045, -061, -070,
 -071, -088, -091, -092, 0123 515 012, -024
Mounting bushing: Cargo 139245



137990

Replacing 1125 884 730
Servicing 0123 320 050



137994

Replacing 1125 884 948
Servicing 0123 320 021
Mounting bushing: Cargo 137575



138180

Replacing 1125 884 573
Servicing 0120 489 490, -491



137991

Replacing 1125 884 913
Servicing 0123 310 010, -011, -012, -013



138000

Replacing 1125 885 524
Servicing 0123 520 002, -005, -014
Mounting bushing: Cargo 137575 x 2

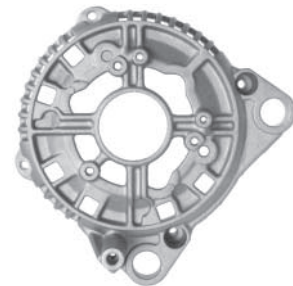

138237

Replacing 1125 885 507, -526
Servicing 0123 505 013, 0123 510 006,
 -007, -026, -027, -032, -034, -053, -054,
 -056, -065, -099, 0123 515 018, -020, -021
Mounting bushing: Cargo 137575

Replacing BOSCH



138239

Replacing 1125 884 672
Servicing 0123 320 026, -030, 0123 335 001
Mounting bushing: Cargo 139245



138276

Replacing 1125 884 342, -357, -392
Servicing 0120 489 003, -004, -005, -007, -017, -063, -077, -080, -081, -186, -196, -197, -203, -207, -211, -243, -249, -262, -274, -275, -276, -282, -283, -322, -359, -386, -712, -714, -758, -785, -857, -867



138280

Replacing 1125 887 006
Servicing 0120 689 504, -505, -507, -511, -514, -517
Mounting bushing : Cargo 138240

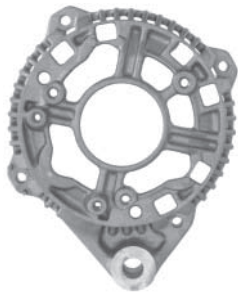

138274

Replacing 1125 883 503
Servicing 0123 115 009, -014
Mounting bushing: Cargo 138245



138278

Replacing 1125 885 264
Servicing 0120 469 101, -103



138428

Replacing 1125 884 472
Servicing 0120 489 190, -358
Mounting bushing: Cargo 135421



138275

Replacing 1125 883 511
Servicing 0123 110 007
Mounting bushing: Cargo 137575



138279

Replacing 1125 885 268, 6033 GC1 028
Servicing 0120 469 102



138777

Replacing 1125 884 728
Servicing 0123 310 038, -039, 0123 320 036, -037, 0123 325 006
Mounting bushing: Cargo 137575

Replacing BOSCH



138778

Replacing 1125 884 734, -909
Servicing 0123 315 008, -015, -017, -018, -019
Mounting bushing: Cargo 138244



138781

Replacing 1125 885 509, -516, -528
Servicing 0123 510 031, -037, -048, -095, -106, -109, 0123 515 003, -008, -009, -011
Mounting bushing: Cargo 137575



138997

Replacing 1125 885 106
Servicing 0120 468 010, -036, -046, -081, -083, -085, -086, -119, -120



138779

Replacing 1125 884 929
Servicing 0123 315 013, 0123 325 010
Mounting bushing: Cargo 138007



138993

Replacing 1125 884 915
Servicing 0123 315 007, -020



139001

Replacing 1125 885 221
Servicing 0123 214 002, 0123 515 002, -007, -010



138780

Replacing 1125 884 925, -944
Servicing 0123 310 018, -019, -024, -025, -032, -034, -035, -037, -040, 0123 320 007, -008, -017, -018, -024, -031, -032, -034, -038, -059
Mounting bushing: Cargo 137575



138995

Replacing 1125 883 086
Servicing 0120 335 007



139027

Replacing 1125 887 019
Servicing 0120 689 522, -527, -540, -541, -543, -548, -549, -552, -561, -562, -563, -566, -569
Mounting bushing: Cargo 138240

Replacing BOSCH



139117

Replacing 1125 884 417
Servicing 0120 488 157, -159, -163, -175, -203, -281

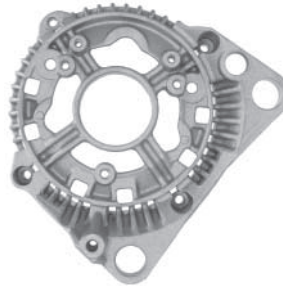

139296

Replacing 1125 884 667
Servicing 0120 485 044, -046, 0123 310 001, -003, -007, 0123 315 002, -006
Mounting bushing: Cargo 137575 x 2



139917

Replacing F00M 116 403
Servicing 0124 225 002, -009, -024, -025
Mounting bushing: Cargo 138091



139184

Replacing 1125 885 065, -087
Servicing 0120 450 011, -012, -013, -014, -016, -017
 Chrysler



139338

Replacing 1125 885 075
Servicing 0120 469 001, -013, -686, -687, -895, -982, 6003 GB3 008

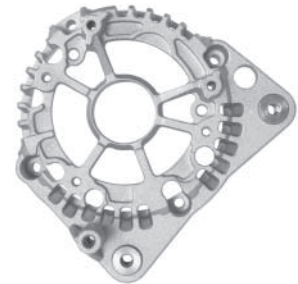

139919

Replacing F00M 126 407
Servicing 0124 315 001, -002, -003, -006, -011, -012, 0124 325 001, -002, -003, -004, -014, -018, -021, -022
Mounting bushing: Cargo 137575 x 2



139280

Replacing 1125 885 241
Servicing 0120 469 018, -033
Mounting bushing: Cargo 139968



139910

Replacing 1125 883 510
Servicing 0123 100 003, 0123 110 006, -008
Mounting bushing: Cargo 138091 x 2



139923

Replacing F00M 136 405
Servicing 0124 515 010, -011, -012, -013, -020, -021, -026, -035, -038
Mounting bushing: Cargo 137575 x 2

Replacing BOSCH

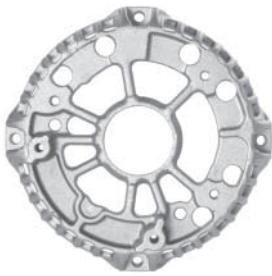

139924

Replacing F00M 136 412
Servicing 0124 515 017, -018, -019, -054



139994

Replacing 1125 884 919
Servicing 0123 310 015



230317

Replacing 1125 885 194, -249
Servicing 0120 469 028, -029, -936, -937, -940
Mounting bushing: Cargo 137343



139974

Replacing 1125 884 931
Servicing 0123 315 016, -021



230169

Replacing 1125 885 537
Servicing 0123 510 068, -079, -081, -100, -101, -102, 0123 520 006, -007, -008, -010, -011, -012, -013, -015, -017



230510

Replacing 1125 885 274
Servicing 0120 468 140
Mounting bushing: Cargo 230508

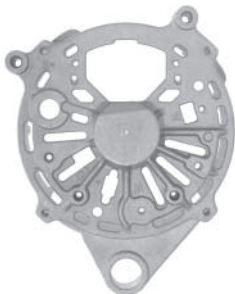

139975

Replacing 1125 885 165
Servicing 0120 450 018, -019, -020, -023, -024, -025, -026, -027, -028, -029



230237

Replacing 1125 885 547
Servicing 0123 510 082, -107, -108, 0123 520 023, -025

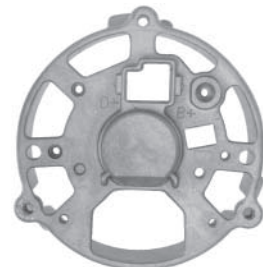

230528

Replacing 1125 883 057
Servicing 0120 339 526

Replacing BOSCH



230600

Replacing 1125 885 139
Servicing 0120 468 037, -114



230693

Replacing 1125 884 673
Servicing 0120 485 030



230712

Replacing 1125 885 254
Servicing 0120 468 127, -128



230619

Replacing 9122 145 821
Servicing 0120 488 002, -003, -004, -005



230703

Replacing 1125 884 244
Servicing 0120 400 600, -601, -602, -603, -614, -615, -620, -621, -622, -623, -624, -625, -626, -627, -628, -629, -630, -631, -634, -635, -637, -643, -644, -649, -650, -653, -654, -655, -656, -657, -658, -659

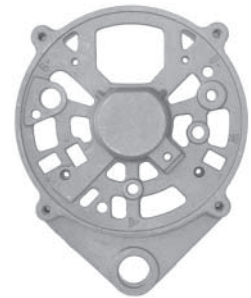

230723

Replacing 1125 885 188
Servicing 0120 468 065, -094, -116, -124, -129, -130, -139, -999, 6033 G30 37B, -39B
Mounting bushing: Cargo 137400



230623

Replacing F00M 126 419
Servicing 0124 315 004, -005, -013, 0124 325 011, -012, -013, -032
Mounting bushing: Cargo 137575 x 2



230704

Replacing 1125 885 156
Servicing 0120 469 036, -040, -041, -693, -796, 6033 G30 14B, 6033 GB3 014, 6033 GB3 053



230725

Replacing 9122 145 861
Servicing 9120 144 256, -258, -265, -266

Replacing BOSCH

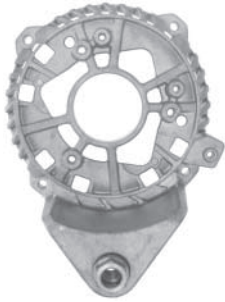

230735

Replacing 1125 884 938
Servicing 0120 485 048
Mounting bushing: Cargo 138087



230968

Replacing 1125 885 260
Servicing 0120 469 100, -107, -108, -109, -110, -111, -112, -113, -114, 6033 GB3 009
Mounting bushing: Cargo 137408
Bearing: Cargo 140081



231069

Replacing 1125 884 679
Servicing 0120 485 036, 0123 320 002, 0123 340 002
Bearing: Cargo 140087



230738

Replacing F00M 126 403
Servicing 0124 415 001, -005, -023
Mounting bushing: Cargo 233574 x 2



230973

Replacing F00M 116 423
Servicing 0124 225 010, -011
Bearing: Cargo 140273



231129

Replacing F00M 126 415
Servicing 0124 325 008, -010
Bearing: Cargo 140273
Mounting bushing: Cargo 138244



230765

Replacing 1125 885 270
Servicing 0120 469 115, -116, -117, 6033 G3B 022, 6033 GB3 019, -022, -027
Bearing: Cargo 140081



231017

Replacing F00M 116 405
Servicing 0124 225 001, -004, -022, -023
Bearing: Cargo 140273
Mounting bushing: Cargo 233574 x 2



231156

Replacing 1125 887 023
Servicing 0120 689 524, -538, -539, -550
Bearing: Cargo 140515

Replacing BOSCH

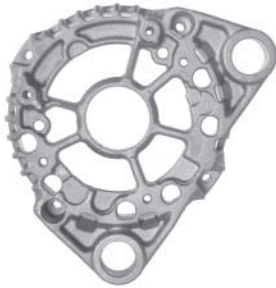

231254

Replacing F00M 126 417
Servicing 0124 415 006
Bearing: Cargo 140273
Mounting bushing: Cargo 231257



231594

Replacing 9121 335 952
Servicing 0120 468 143, -145,
 6033 GB3 010, -023
Bearing: Cargo 140081

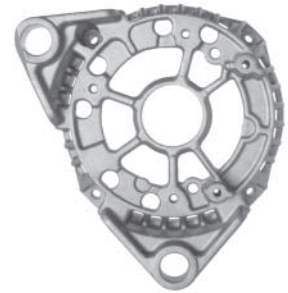

231753

Replacing F00M 136 410
Servicing 0124 515 005, -006, -008, -032,
 -043, -049, -080, -081, -085,
 0124 525 012, -013, -018, -021, -022, -030
Bearing: Cargo 140273
Mounting bushing: Cargo 233574 x 2

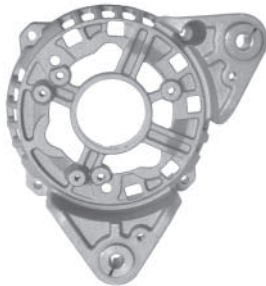

231261

Replacing 1125 884 732, -933
Servicing 0123 310 023, -029, -048, -054,
 -055
Bearing: Cargo 140087

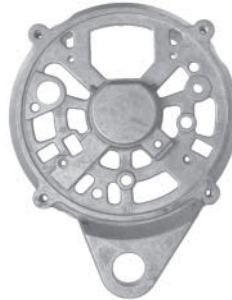

231702

Replacing 1125 885 129
Servicing 0120 468 028, -054, -055, -136,
 -147
Bearing: Cargo 140105
Mounting bushing: Cargo 138241



231757

Replacing 1125 883 070, -088
Servicing 0120 335 012, 0123 110 004
Mounting bushing: Cargo 231560



231463

Replacing 1125 883 039
Servicing 0120 300 569, 0120 339 516,
 -523, -528
Bearing: Cargo 140116



231719

Replacing 1125 885 256, 6033 GD1 016
Servicing 0120 468 131, 6033 GB3 033,
 -034, 6033 G30 57B, -60B
Bearing: Cargo 140105



231761

Replacing F00M 116 409
Servicing 0124 215 001, -002, -003,
 0124 225 016
Bearing: Cargo 140273
Mounting bushing: Cargo 138240

Replacing BOSCH



232234

Replacing 1125 884 688
Servicing 0123 325 003, -013
Bearing: Cargo 140087
Mounting bushing: Cargo 139592



233523

Replacing F00M 126 439
Servicing 0124 315 019, -027
Bearing: Cargo 140273



233566

Replacing 9121 337 077
Servicing 6033 GB4 009, 9120 334 641
Bearing: Cargo 140116



233474

Replacing 1125 885 253
Servicing 0123 510 023, -038 -039, -049, -050, -051, -058, -066, -067, -080, 0123 520 006, -007, -008
Bearing: Cargo 140087



233558

Replacing F00M 126 421
Servicing 0124 325 009, -054, -058, -059, -065
Bearing: Cargo 140273
Mounting bushing: Cargo 230079



233648

Replacing 1125 885 233
Servicing 0123 212 001
Bearing: Cargo 140087

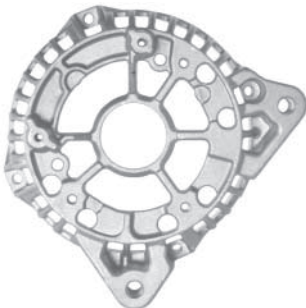

233506

Replacing F00M 136 420
Servicing 0124 615 002
Bearing: Cargo 140273



233559

Replacing F00M 126 431
Servicing 0124 415 011, -012
Bearing: Cargo 140273
Mounting bushing: Cargo 230079



233650

Replacing F00M 126 425
Servicing 0124 415 002, -008, -010, -028
Bearing: Cargo 140273
Mounting bushing: Cargo 138091

Replacing BOSCH

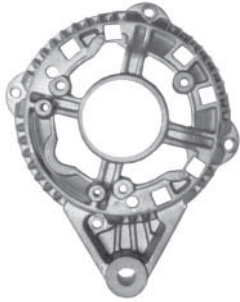

233782

Replacing 1125 883 085
Servicing 0120 335 006
Bearing: Cargo 140087



234030

Replacing F00M 126 427
Servicing 0124 320 001, -002,
 0124 325 052
Bearing: Cargo 140093
Mounting bushing: Cargo 138244



234223

Replacing 1125 884 646
Servicing 0120 488 252, -253
Bearing: Cargo 140105
Mounting bushing: Cargo 137461



233870

Replacing 1125 883 507
Servicing 0123 115 011
Bearing: Cargo 140087
Mounting bushing: Cargo 138244



234033

Replacing 1125 885 169
Servicing 0120 468 057, -058
Bearing: Cargo 140081

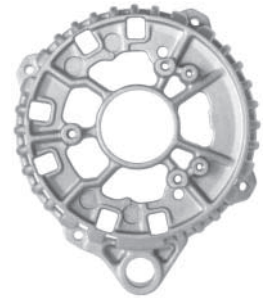

234355

Replacing 1125 885 549
Servicing 0123 520 500, 0123 525 500,
 -502, -503
Bearing: Cargo 140087
Mounting bushing: Cargo 138245



234003

Replacing 1125 884 391
Servicing 0120 400 669, -670, -724, -733,
 -745, -747, 0120 489 008, -009, -010,
 -011, -012, -013, -014, -015, -062, -076,
 -082, -083, -198, -199, -200, -201, -204
Bearing: Cargo 140081



234057

Replacing F00M 126 423, -486
Servicing 0124 315 007, -008,
 0124 325 015, -016, -033, -051, -057, -075,
 -106
Bearing: Cargo 140273
Mounting bushing: Cargo 137575

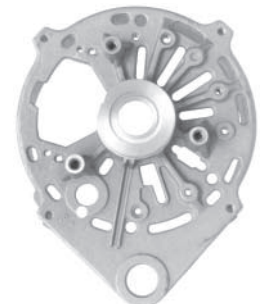

234521

Replacing 9121 337 0889
Servicing 9120 335 000, -001
Bearing: Cargo 140081,
Mounting bushing: Cargo 137263

Replacing BOSCH



234525

Replacing 1125 885 556, -558
Servicing 0123 525 501
Bearing: Cargo 140087
Mounting bushing: Cargo 139592



234838

Replacing F00M 136 498, -548 
Servicing 0124 515 022, -039, -068, -101,
 0124 525 027, -074, -090, -093, -095, -103
Bearing: Cargo 140273
Mounting bushing: Cargo 137575 x 2



235045

Replacing F00M 136 506 
Servicing 0124 510 001, 0124 515 044,
 -113, -120, 0124 525 020, -064,
 0124 555 005, -010
Bearing: Cargo 140273
Mounting bushing: Cargo 138244



234530

Replacing F00M 126 473
Servicing 0124 415 007, -013, -014
Bearing: Cargo 140093



234844

Replacing 1125 885 530 
Servicing 0123 505 018, 0123 510 046,
 -047, 0123 515 016
Bearing: Cargo 140087
Mounting bushing: Cargo 137575



235104

Replacing F00M 136 416, -496 
Servicing 0124 515 024, -025, -027, -028,
 -034, -040, -058, 0124 525 008
Bearing: Cargo 140273
Mounting bushing: Cargo 233920



234748

Replacing F00M 126 433 
Servicing 0124 325 024, -031
Bearing: Cargo 140273



235044

Replacing F00M 136 441 
Servicing 0124 515 103, -111, -116, -122,
 0124 555 001, -002, -003, -004, -007, -011,
 -012, -015, -016, -021, -022, -025, -029, -032
Bearing: Cargo 140273
Mounting bushing: Cargo 138089



235221

Replacing F00M 126463 
Servicing 0124 415 009, -016, -025, -026,
 -030, -032
Bearing: Cargo 140273

Replacing BOSCH



235323

Replacing 1125 884 741

Servicing 0123 325 500

Bearing: Cargo 140087

Mounting bushing: Cargo 139592



Bracket Parts



232309

Replacing 1121 331 500

Servicing 0123 325 002

Mounting bracket



232461

Replacing 9123 141 300

Servicing 0120 489 393, -394,

9420 144 254, -255, -265, -266

Mounting bracket



132397 Std pkg 5 **A**

Replacing 1120 323 000

Servicing BMW

15 x 23/28 x 20 mm

Mounting bushing, rubber, long



132398 Std pkg 5 **A**

Replacing 1120 321 000

Servicing BMW

15 x 20.8/26.5 x 8.2 mm

Mounting bushing, rubber, short



134774 Std pkg 10 **A**

8 x 13.05 x 20 mm

Mounting bushing, D.E.

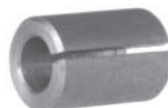

134775 Std pkg 10 **A**

8 x 14 x 20 mm

Mounting bushing, D.E. Oversize



134964 Std pkg 5 **A**

10 x 15 x 18 mm

Mounting bushing, D.E.



135061 Std pkg 5 **A**

11.5 x 14 x 50 mm

Mounting bushing, D.E.



135211 Std pkg 10 **A**

8.2 x 13.6 x 20 mm

Mounting bushing, D.E.



135216 Std pkg 5 **A**

8.4 x 14.0/20.0 x 13.0 mm

Mounting bushing, D.E.

Replacing BOSCH



135421 Std pkg 5
Replacing 1120 322 013
 10 x 16.5/22 x 20.7 mm
 Mounting bushing, S.R.E.



137379 Std pkg 5
Replacing 1120 300 017
 8 x 18 x 22 mm
 Mounting bushing, S.R.E.



137575 Std pkg 5
Replacing 1120 300 041, -508
 M8-1.25, 18 x 20 mm
 Mounting bushing, S.R.E.



137262 Std pkg 5
Replacing 1120 300 023
 10.3 x 21 x 22 mm
 Mounting bushing, S.R.E.



137400 Std pkg 5
Replacing 1120 300 034
 10 x 19.03 x 18.3 mm
 Mounting bushing, S.R.E.



137737 Std pkg 5
 8.5 x 11/19.5 x 11.1 mm
 Mounting bushing, D.E. and S.R.E.



137263 Std pkg 5
Servicing 9120 144 605, -606
 10 x 18.1 x 20 mm
 Mounting bushing, S.R.E.



137408 Std pkg 5
Replacing 1120 300 025
 12.2 x 21.1 x 27 mm
 Mounting bushing, S.R.E.



138086 Std pkg 5
Replacing 1120 300 035
 8.5 x 18.07 x 20 mm
 Mounting bushing, S.R.E.



137343 Std pkg 5
Replacing 1120 300 014
 12.3 x 18.08 x 22 mm
 Mounting bushing, S.R.E.



137461 Std pkg 5
Replacing 1120 300 015
 12.3 x 18 x 27 mm
 Mounting bushing, S.R.E.



138087 Std pkg 5
Replacing 1120 300 045
 M10-1.5 / 21 x 32 mm
 Mounting bushing, S.R.E.

Replacing BOSCH



138088 Std pkg 5
Replacing 1120 300 514
 8 x 21 x 20 mm
 Mounting bushing, S.R.E.



138240
Replacing 1120 300 018
 12.5 x 21.2 x 25 mm
 Mounting bushing, S.R.E.



138245
Replacing 1120 322 018, -501
 10.3 x 17.9/25 x 26.5 mm
 Mounting bushing, D.E.



138089 Std pkg 5
Replacing 1120 322 016
 11 x 14.1/21.5 x 8.1 mm
 Mounting bushing, D.E.



138241
Replacing 1120 300 019
 13.3 x 21.2 x 20 mm
 Mounting bushing, D.E.



138451
Replacing 1120 322 002
Servicing 0120 400 617, 0120 469 585
 8 x 13/16 x 21 mm
 Mounting bushing



138090 Std pkg 5
Replacing 1120 320 027
 10.45 x 18.05/22 x 17.5 mm
 Mounting bushing, D.E.



138243
Replacing 1120 322 015
 9 x 11/20 x 8 mm
 Mounting bushing, D.E.



139245
Replacing 1120 300 515
Servicing 0120 465 007, -008, -023,
 0120 485 017, -018, -028, 0123 310 022
 10.2 x 21.0 x 18 mm
 Mounting bushing, S.R.E.



138091 Std pkg 5
Replacing 1120 322 502
 10.35 x 18/21.9 x 21.1 mm
 Mounting bushing, D.E. and S.R.E.



138244
Replacing 1120 322 017
 10.6 x 18.1/21.9 x 18.1 mm
 Mounting bushing, S.R.E.



139246
Replacing 1120 322 019
Servicing 0120 488 249
 11.2 x 13/20 x 18 mm
 Mounting bushing, D.E.

Replacing BOSCH



139592
Replacing 1120 322 028
 10.5 x 18/24.9 x 26.5 mm
 Mounting bushing, D.E.



230220 Std pkg 10
 8 x 13.05 x 11 mm
 Mounting bushing, D.E.



231560
Replacing 1120 322 505
Servicing 0120 335 011, -012,
 0120 468 131, -132, 1125 883 087, -088,
 6033 GD1 016, -017, 9120 144 302
 10 x 18.2/22 x 15 mm
 Mounting bushing, S.R.E.



139966 Std pkg 5
 10 x 15 x 13 mm
 Mounting bushing, D.E.



230508
Replacing 1120 322 030
Servicing 0120 468 140, -150
 10.2 x 20.2 x 22.0 mm
 Mounting bushing, S.R.E.



231569 Std pkg 5
 11.2 x 14 x 23 mm
 Repair bushing for Cargo 138032, D.E.



139968 Std pkg 5
Replacing 1120 300 048
 13.4 x 21.3 x 27.0 mm
 Mounting bushing, S.R.E.



230910
Replacing 1120 322 003
Servicing 0120 469 036, -101, -103, -518,
 -687, -796
 10.2 x 16.8/21.5 x 13.0 mm
 Mounting bushing, D.E.



233214
Replacing 1120 300 046
Servicing 0120 468 128
 10.3 x 21.0 x 43.0 mm
 Mounting bushing, S.R.E.



230079 Std pkg 5
Replacing 1120 300 509
 12.3 x 21.1 x 22.1 mm
 Mounting bushing, S.R.E.



231257
Replacing F00M 147 001
 M8-1.25 x 21 x 20 mm
 Mounting bushing, S.R.E.



233569
Replacing 1120 322 005
 10.4 x 16.5/26 x 13 mm
 Mounting bushing, D.E.

Replacing BOSCH



233574

Replacing F00M 147 003
M10 x 18/22 x 21 mm
Mounting bushing, S.R.E.



233920

Replacing 1120 300 516
Servicing 0123 320 028, 0123 510 070,
-092, 0123 515 024, 0123 520 004, -019,
-020, -021, -026, -027, -031
M10 x 21 x 25 mm
Mounting bushing, S.R.E.

233998

Replacing 1120 320 021
Servicing 0120 469 882, -883, -915, -916,
-935, -994, -995
8 x 15/25 x 20 mm
Mounting bushing, D.E.



233995

Replacing 1120 390 005
Servicing 0120 469 837, -838, -882, -883,
-915, -916, -935
8.1 x 24.1 x 28.1 mm
Mounting bushing, rubber



234001

Replacing 1120 206 002
Servicing 0120 469 837, -838, -882, -883,
-915, -916, -935, -994, -995
15 x 27 x 6 mm
Mounting bushing, rubber



234002

Replacing 1120 206 003
Servicing 0120 469 994, -995
15 x 27 x 8.5 mm
Mounting bushing, rubber

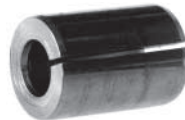

234265

Replacing 1120 300 033
Servicing 0120 450 018, -019, -020, -021,
-022, -023, -024, -025, -026, -027, -028,
-029, -030, -031
10.84 x 21.07 x 29.57 mm, Type split
Mounting bushing



131820 A

Servicing 0120 469 538, -539, -593,
-594, -595, -617, -618, -619
BMW 45, 55, 65 Amp. alternators
Thin ear, 25 mm
Mounting bushing kit



131821 A

Servicing 0120 489 036, -038, -039, -045,
-046, -533, -534, -537, -538, -543, -544
BMW 45, 55, 65 Amp. alternators
Thick ear, 51 mm
Mounting bushing kit



133641 A

Servicing BMW 85-90 Amp. alternators
Thick ear, 56 mm
Mounting bushing kit



234383

Replacing 1120 320 020
Servicing 0120 469 837, -838, -882, -883,
-916, -935, -994, -995
8 x 15/25 x 20 mm
Mounting bushing



132734 Std pkg 5 A

Replacing 9491 140 202, -204
Servicing 0120 488 000, -001, -002, -003
12 x 24 x 6 mm
Oil seal, S.R.E.

Replacing BOSCH



136014 A
Replacing 1120 283 000
Servicing 0120 689 502, -503, -504, -505, -506, -507, -508, -510, -511, -512, -513
 20 x 35 x 7 mm
 Oil seal, S.R.E.



136016 A
Replacing 2120 283 000
Servicing 0120 600 ...
 38 x 52 x 7 mm
 Oil seal, D.E.



235142 
Replacing 2120 283 004
Servicing 0120 689 519, -529, -536, -537, -544, -547, -554, -556, -560
 30 x 47 x 7 mm
 Oil seal



135369 Std pkg 5
Replacing 1121 038 018
Servicing 0120 469 ...
 Bearing retainer



135608 Std pkg 5
Replacing 1121 038 015, -017
Servicing 0120 465 ...
 Bearing retainer



136007
Replacing 2120 516 011
Servicing 0120 600 515, -525, -544, -562, -563, -565, -567, -570, -571, -574, -579
 Bearing retainer



136015
Replacing 1120 033 009
Servicing 0120 689 520, -522, -523
 Bearing retainer



137090 Std pkg 5
Replacing 1120 136 000
Servicing 0120 469 ...
 Bearing retainer



137409 Std pkg 5
Replacing 1121 038 500
 Bearing retainer



138093 Std pkg 5
Replacing 1121 038 020
 Bearing retainer



138248 Std pkg 5
Replacing 1120 551 000
 Bearing retainer



230975
Replacing F00M 146 800
Servicing 0124 225 010, -011, -020, 0124 315 019, 0124 415 009, 0124 510 001, 0124 515 033, -042, -044
 O.D. 64.2 mm, I.D. 41.7 mm
 Bearing retainer

Replacing BOSCH



234362

Replacing 1121 038 016
Servicing 0120 468 028, -055, -136, -147, 0120489 682
 30 mm hole, 65 x 65 mm
 Bearing retainer



131828 Std pkg 5 A

Replacing 1120 591 082
Servicing 0120 469 . . . , 6201
 O.D. 35 mm, I.D. 32 mm, L. 15 mm
 Bearing cap, S.R.E.



132769 Std pkg 5 A

Replacing 1120 591 075
Servicing 6201, 140081
 O.D. 35 mm, I.D. 34 mm, L. 42 mm
 Bearing cap, S.R.E.



135237 Std pkg 5 A

Replacing 1120 591 076, -103
Servicing 0120 485 005, -006, -007, -008
 O.D. 43 mm, I.D. 40 mm, L. 16.6 mm
 Alternator w/ internal fan
 Bearing cap, S.R.E.



135407 Std pkg 5 A

Replacing 1120 591 102, -116
Servicing 0120 335 006, -007, -011, -012
 Bearing cap, S.R.E.



136235 Std pkg 5 A

Replacing 1120 591 060
Servicing 62201, 140105
 O.D. 35 mm, I.D. 32 mm, L. 18.8 mm
 Bearing cap, S.R.E.



139929 Std pkg 5 A

Replacing F00M 146 900
Servicing 0124 215 001, -002, -003, -004, -005, 0124 220 002, 0124 225 001, -002, -004, -009, -013, -014, -015, -016, -019, -021, -022, -023, -024, -025, -026, -027
 Bearing cap, S.R.E. for 6003, Cargo 140273



232294

Servicing 0122 468 015, 0122 0AA 1S0
 O.D. 43 mm, I.D. 40 mm, L. 15 mm
 Bearing cap, S.R.E.

234584

Servicing 9120 335 000, -001
 O.D. 38 mm, I.D. 32 mm, L. 11 mm
 Bearing cap



134552 Std pkg 10 A

Replacing 1120 150 001
 26 x 23.5 x 0.3 mm
 For bearing 6000 series
 Bearing spring



140438 Std pkg 10 A

Replacing 1120 150 000
Servicing bearing 6200 series
 29.7 x 22.5 x 0.3 mm
 Bearing spring



140439 Std pkg 10

Servicing bearing 6201 series
 31.7 x 26.5 x 0.4 mm
 Bearing spring

Also see O-ring Survey
page 854

Replacing BOSCH



140524 Std pkg 5 A

Servicing 0120 488 000, -001, -002, -003
Scania alternators (Bearing Cargo 140116)
28 x 35 x 13 mm
Bearing sleeve
Used in: Cargo 137698, 9122 145 806
O-ring: Cargo 135357



135357 Std pkg 10

Replacing 9491 140 203
Servicing 0120 300 . . . , -339 . . .
28 x 2 mm
O-ring
Used w/ Cargo 140524



138007 Std pkg 5

Replacing 1120 210 001
32 x 2 mm
O-ring

Covers



134560

Replacing 1125 500 054
Servicing 0120 468 042, -043,
0120 469 868, -869, -876, -877, -902



135241

Replacing 1125 500 128
Servicing 0120 485 034, -036, -038,
-039, -043



135239

Replacing 1125 500 062, -167
Servicing 0120 485 025, -026



135379

Replacing 1125 500 077
Servicing 0120 485 015



135240

Replacing 1125 500 117, -190, -623
Servicing 0120 485 011, -012, -022,
0123 310 008, -041, 0123 315 005,
0123 320 010, -011, -029, -039, -040,
-041, -044, -045, -046, -047, -049, -051,
-057, -060, -061, -062, -065



135386

Replacing 1125 500 085, -152
Servicing 0120 335 006, -007

Replacing BOSCH



135398

Replacing 1125 500 110, -123
Servicing 0120 465 020, -021



135607

Replacing 1125 500 192
Servicing 0120 465 003, -004, -013, -014, -015, -016, -017



136484

Replacing 1125 500 154, -510, -572
Servicing 0123 110 005, 0123 120 001



135442

Replacing 1125 500 079
Servicing 0120 485 029, -030, 0123 310 014, -015, -029, 0123 320 014



136047

Replacing 1125 500 022
Servicing 0120 468 062, -064, -907, -912, 1120 468 103



136486

Replacing 1125 500 072, -120
Servicing 0120 468 075, -076, -077, -078, -105, -111, 0120 469 004, -005, -006, -007, -966, -967, -968, -969, -984, -985



135548

Replacing 1125 500 174, -562
Servicing 0120 485 020, -032, -046, 0123 114 005, 0123 340 001



136395

Replacing 1125 500 519, -647
Servicing 0123 310 015, -029, -053



136705

Replacing 1125 500 518, -583
Servicing 0123 310 010, -011, -012, -013

Replacing BOSCH



136772

Replacing 1125 500 168
Servicing 0123 212 001



136860

Replacing 1125 500 179
Servicing 0120 465 008, 0123 505 007,
 0123 510 014



137146

Replacing 1125 500 501
Servicing 1123 505 011, -012, -013



136833

Replacing 1125 500 165, -511, -568
Servicing 1123 505 001, -002, -003, -004



137144

Replacing 1125 500 111
Servicing 0120 465 031



137147

Replacing 1125 500 543
Servicing 0123 510 031



136848

Replacing 1125 500 044
Servicing 0120 488 139, -141, -151, -152,
 0120 489 127, -188, -307, -349, -351,
 -353, -400, -401, -402, -424, -498



137145

Replacing 1125 500 157
Servicing 0123 315 004



137438

Replacing 1125 500 135
Servicing 0123 500 004, 0123 510 017,
 0123 545 001, -002, -003

Replacing BOSCH



137445

Replacing 1125 500 546, -614
Servicing 0123 310 023, 0123 320 050



137828

Replacing 1125 500 023
Servicing 0120 689 503, -506, -508, -512, -513, -515, -520, -523, -526, -530, -532, -533, -534, -535, -546



138098

Replacing 1125 500 144, -523
Servicing 0123 505 018, 0123 510 008, -009, -099, 0123 515 003, -008, -009, -011, 0123 520 014



137450

Replacing 1125 500 172
Servicing 0123 310 022, 0123 320 016



138095

Replacing 1125 500 112
Servicing 0120 485 048



138099

Replacing 1125 500 148, -527
Servicing 0123 505 008, -009, 0123 510 015, -033, -045, -071, -088, -089, -091, 0123 515 012, -024



137474

Replacing 1125 500 070
Servicing 0120 485 050



138097

Replacing 1125 500 627
Servicing 0123 325 002, -003, -012, -013



138100

Replacing 1125 500 187
Servicing 0123 510 003, -052

Replacing BOSCH



138101

Replacing 1125 500 188
Servicing 0123 310 006



138104

Replacing 1125 500 533
Servicing 0123 315 016, -021



139023

Replacing 1125 500 504
Servicing 0123 510 013



138102

Replacing 1125 500 521
Servicing 0123 510 004, -018, -021, -023, -038, -039, -044, -049, -050, -051, -058, -059, -066, -067, -072, -074, -075, -080



138105

Replacing 1125 500 541
Servicing 0123 310 027, 0123 320 021



139031

Replacing 1125 500 515, -558, -566
Servicing 0123 315 008, -015, -017, -018, -019

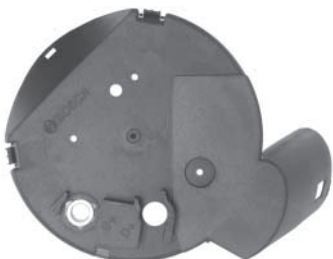

138103

Replacing 1125 500 525
Servicing 0123 500 007, 0123 510 020, -064



139003

Replacing 1125 500 584
Servicing 0123 515 002, -010



139262

Replacing 1125 500 136
Servicing 0123 214 002

Replacing BOSCH



139656

Replacing F00M 126 603, F00M 146 639
Servicing 0124 225 012, 0124 315 001, -002, -003, -004, -005, -006, -007, -008, -010, -011, -012, -013, -014, -018, -022, 0124 320 002, 0124 325 001, -002, -003, -011, -012, -013, -014, -016, -017, -018



139928

Replacing F00M 146 626
Servicing 0124 225 013, -014, -015, -019, -021, 0124 320 001, 0124 325 024, 0124 415 007, -013, -014, 0124 515 001, -015, -017, -019, -044, -054



230184

Replacing 1125 500 596
Servicing 0123 510 068, -079, -081, -082, -100, -101, -102, -107, 0123 520 006, -007, -008, -010, -011, -012, -013, -023



139809

Replacing 1125 500 528
Servicing 0123 515 004



230125

Replacing 1125 500 610
Servicing 0123 100 003, 0123 110 008



230235

Replacing 1125 500 063, -121, -131, -581
Servicing 0120 465 026, -027, -028, 0123 510 010, -011, -048, -095



139926

Replacing F00M 146 609
Servicing 0124 225 001, -002, -004, -009, -022, -023, -024, -025, 0124 415 001, -002, -005, -008, -010, 0124 515 004, -005, -006, -008, -020, -021, -023, -031, -032, -043



230178

Replacing F00M 146 622, -641, -642
Servicing 0124 215 001, -003, -004, -005, 0124 225 026, -027, 0124 325 009, -028, 0124 415 006, -011, -012, -015



230974

Replacing F00M 146 650
Servicing 0124 225 010, -011

Replacing BOSCH



231165

Replacing 1125 500 643
 Servicing 0123 510 108, 0123 520 025



231794

Replacing 1125 500 576
 Servicing 0123 110 006



232179

Replacing 1125 500 625
 Servicing 0123 315 022



231168

Replacing 1125 500 545
 Servicing 0123 515 007



232177

Replacing 1125 500 586
 Servicing 0123 510 060



232180

Replacing F00M 146 617
 Servicing 0124 325 008



231188

Replacing 1125 500 529
 Servicing 0123 315 013, 0123 325 010



232178

Replacing 1125 500 634
 Servicing 0123 520 017



232192

Replacing F00M 146 644
 Servicing 0124 615 002

Replacing BOSCH



232210

Replacing 1125 500 588
Servicing 0123 315 500, -502



232833

Replacing F00M 146 622
Servicing 0124 415 006



233653

Replacing F00M 146 707
Servicing 0124 515 050, -097



232431

Replacing 1125 500 535
Servicing 0123 505 014, -016



233575

Replacing 1125 500 604
Servicing 0123 325 005, -006



233721

Replacing 1125 500 579
Servicing 0123 320 035, -058



232457

Servicing 0122 468 015



233588

Replacing F00M 146 675
Servicing 0124 315 015, -016, -024, -025,
0124 325 071, -079, -085, -086



233725

Replacing F00M 146 718
Servicing 0124 415 025, -026,
0124 425 004, 0124 515 095, -096,
0124 525 017

Replacing BOSCH



233866

Replacing 1125 500 578
Servicing 0123 325 004, -008

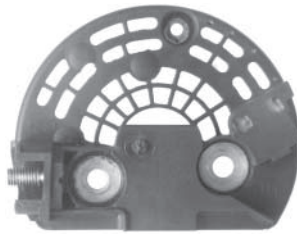

234150

Replacing F00M 146 692
Servicing 0124 325 030, -062, -072, -087, 0124 515 051, -098, 0124 525 042, -045



234527

Replacing 1125 500 641
Servicing 0123 525 501



233972

Replacing 1125 500 621
Servicing 0123 520 500, 0123 525 500, -502, -503



234228

Replacing 1125 500 087, -559
Servicing 0120 335 008, 0123 115 008, -010, -011



234549

Replacing F00M 146 652
Servicing 0124 325 039, -040, -045, -046, -077, -089, -093, -105, -117, 0124 515 045, -046, -047, -048, -055, -056, -060, -061, -062, -064, -079, -088, -091, -102, -114, -118, 0124 615 012, -013



234131

Replacing 1125 500 553
Servicing 0123 310 033



234235

Replacing 1125 500 509
Servicing 0123 115 012, -013



234658

Replacing F00M 146 781
Servicing 0120 525 034, 0124 525 035, -063

Replacing BOSCH



234660

Replacing 1125 500 633
 Servicing 0123 510 093



234832

Replacing F00M 146 116
 Servicing 0124 525 012, -046



237631

Replacing 1125 500 594
 Servicing 0123 315 501



234759

Replacing 1125 500 104
 Servicing 0120 465 018, 0123 213 007



235178

Replacing 1125 500 503
 Servicing 1123 115 009, -014



234769

Replacing F00M 146 659
 Servicing 0124 555 001, -002, -004,
 0124 655 001, -002



235261

Replacing 1125 500 636
 Servicing 0123 325 500



Replacing BOSCH

Regulators



130013

Replacing 0192 052 007
Servicing 0120 489 565, -566
 12 V.
 Slip ring O.D. 28 mm



130675

Replacing 0192 062 001
 12 V.
Adjustable type: Cargo 136325



130678

Replacing 0192 033 005
 24 V.
 Terminals D-/DF/D+/L



130015

Replacing 0190 700 002
 24 V.
 4 terminals



130676

Replacing 1197 311 090
 12 V.
 Slip ring O.D. 32 mm
Cover: Cargo 137361



130958

Replacing 1197 311 005, -021
Servicing 0120 468 001, -002, -003, -006, -070, 0120 469 002, -003, -006, -011, -012, -015, -541, -542, -543, -545, -546
 12 V.
 Slip ring O.D. 28 mm



130592

Replacing 0192 053 002
Servicing 0120 339 557, 0120 399 558, 0120 469 509, 0120 489 638, -681, -682, -793, -794, -795, -796
 K1 and G1 alternators
 24 V.
 Slip ring O.D. 32 mm



130677

Replacing 0192 033 004
 24 V.
 Terminals D-DF-D+



130960

Replacing 0192 053 006
Servicing 0120 469 527, -691, -752, -753, 0120 488 125, -232, 0120 489 053, -060, -071, -221, -230, -231, -284, -684, -727
 24 V.
 Slip ring O.D. 28 mm

Replacing BOSCH



131296

Replacing 0192 052 023
Servicing 0120 489 059, -998, -999,
 9120 144 218, -219, -220, -232, -233
 12 V.
 Slip ring O.D. 32 mm



132310

Universal
 Adjustable voltage 28 - 32 V.
 77 x 93 x 42 mm



132737

Replacing 9191 337 302
Servicing 9120 144 257, -258, -260, -262,
 -264, -267, -268
 12 V.
 Slip ring O.D. 28 mm



131340

Replacing 0192 053 014, 1197 311 315
Servicing 0120 689 503, -515
 24 V.
 Slip ring O.D. 32 mm

Volt setting 14.6 V.



132665

Replacing 1197 311 028, -050
 Same as 130958
 12 V.
 Slip ring O.D. 28 mm



132903

Replacing 1197 311 301
 24 V.
 Slip ring O.D. 28 mm
 Gasket: Cargo 136435



131375

Replacing 0192 052 030
Servicing 9120 144 231
 12 V.
 Slip ring O.D. 28 mm

Volt setting 14.6 V.



132666

Replacing 1197 311 030, -045
Servicing 0120 469 013, -522, -526, -532,
 -540, -629, -630, -687, -749, -762, -843
 12 V. Slip ring O.D. 28 mm
 For alternators with sealed slip ring space
 Gasket: Cargo 136435



132980

Servicing 0120 469 589, 0120 489 931
 Same as Cargo 133378
 12 V.
 Slip ring O.D. 28 mm
 W/ add. resistor 68 Ohm

Replacing BOSCH

Volt setting 14.6 V.



133095

Same as Cargo 130676
12 V.
Slip ring O.D. 32 mm

Volt setting 28.8 V.



133781

Replacing 0192 053 019
Servicing 0120 469 807
24 V.
Slip ring O.D. 28 mm



134687

Replacing 1197 311 212
Servicing 0120 485 015, -024, -025,
0123 100 001, -002, 0123 310 004, -016,
-026, -033, 0123 320 023, 0123 345 004
12 V.
Slip ring O.D. 14 mm



133378

Replacing 1197 311 003, -007, -023, -035
12 V.
Slip ring O.D. 28 mm
W/ add. resistor 68 Ohm

Volt setting 14.8 V.



133993

Replacing 1197 311 018, -039
Same as Cargo 133378
12 V.
Slip ring O.D. 28 mm
W/ resistor 68 Ohm

Volt setting 14.5 V.



134761

Replacing 1197 311 211, -213, -217, -219
Servicing 0120 485 011, -012, -022
12 V.
Slip ring O.D. 14 mm
W/ resistor 180 Ohm

Adjustable voltage



133501

Same as Cargo 130676,
but adjustable voltage
14.5 V. ± 0.6 V.
Slip ring O.D. 32 mm

Volt setting 15.0 V.



134342

Same as Cargo 130676
12 V.
Slip ring O.D. 32 mm



135797

Replacing 1197 311 026, -027, -038, -040
12 V.
Slip ring O.D. 28 mm
For heavy-duty alternators

Replacing BOSCH

Volt setting 28.5 V.



135856

Replacing 1197 311 304
Servicing 0120 468 065, -066, -093, -094, -114, -116, -118, -124, -129, -130, 0120 469 010, -014, -018, -022, -023
 24 V.
 Slip ring O.D. 28 mm

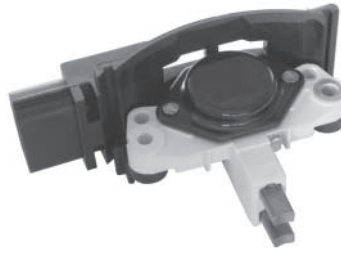

136468

Replacing 1197 311 251, -526
Servicing 0120 335 008, 0123 115 010, -011
 12 V.
 Slip ring O.D. 14 mm
 W/ battery sensing



136555

Replacing 9190 067 018
Servicing 9120 060 023
 12 V.
 Slip ring O.D. 28 mm

Adjustable voltage



136325

12 V.
 Same as Cargo 130675 but adjustable

Volt setting 28.5 V.



136545

Replacing 1197 311 308, -312
Servicing 0120 469 024, -983
 24 V.
 Slip ring O.D. 28 mm
 Insulated return

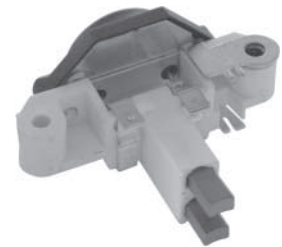

137117

Replacing 1197 311 500, -530, -531, -548
Servicing 0123 505 011, -012, -013
 12 V.
 Slip ring O.D. 14 mm

Adjustable voltage



136433

Replacing 1197 311 313
Servicing 0120 488 234, -283
 24 V.
 Slip ring O.D. 28 mm



136554

Replacing 9190 067 016, -017, -019, -020
Servicing 9120 060 009
 12 V.
 Slip ring O.D. 28 mm



137127

Adjustable version of cargo 133378
 12 V.
 W/ resistor 120 Ohm
 Slip ring O.D. 28 mm

Replacing BOSCH



137152

Replacing 0192 053 021, 1197 311 320
Servicing 0120 689 518, -524, -531, -534, -538, -539, -545, -550
 24 V.
 Slip ring O.D. 28 mm
 Insulated

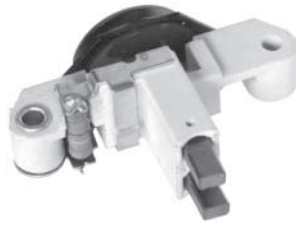

137342

Replacing 1197 311 239
Servicing 0120 465 006, 0123 545 003, 0123 510 017
 12 V.
 W/ resistor 68 Ohm
 Slip ring O.D. 14 mm



138107

Replacing 1197 311 501
Servicing 0123 325 003, -013
 12 V.
 Slip ring O.D. 14 mm
 W/ battery sensing



137183

Replacing 1197 311 523
Servicing 0123 310 023, -048
 12 V.
 Slip ring O.D. 14 mm

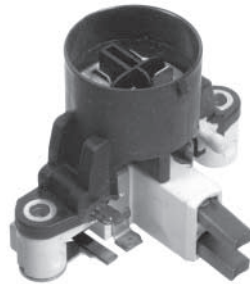

137406

Replacing 1119 311 231
Servicing 0120 485 050
 12 V.
 Slip ring O.D. 14 mm

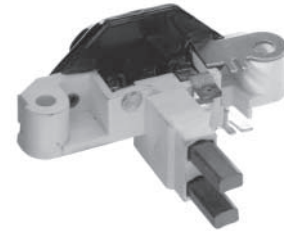

138108

Replacing 1197 311 512, -551
Servicing 0120 335 007, -011, -012, 0123 110 007, 0123 310 010, -011, -012, -013
 12 V.
 Slip ring O.D. 14 mm



137217

Replacing 0192 053 024, 1197 011 000
Servicing 0120 689 519, -529, -536, -537, -544, -547, 0122 469 001, -002, -003, -004
 Caterpillar
 24 V.
 Brushless, Insulated



137723

Replacing 9191 337 310
Servicing 0120 469 103, 6033 GB3 047
 24 V.
 Slip ring O.D. 28 mm



138109

Replacing 1197 311 518, -520, -555
Servicing 0123 315 016 -021, 0123 505 015, -016, 0123 510 108
 12 V.
 Slip ring O.D. 14 mm

Replacing BOSCH



138110

Replacing 1197 311 521
Servicing 0123 320 021, 0123 510 031
 12 V.
 Slip ring O.D. 14 mm



138292

Replacing 1197 311 310
Servicing 0120 488 206, -294,
 6033 G20 04B
 Komatsu PC 210-6
 24 V.
 Slip ring O.D. 28 mm

Volt setting 29 V.



138756

Same as Cargo 132903
 24 V.
 Slip ring O.D. 28 mm



138139

Replacing 9191 337 309
Servicing 9120 334 631, -632
 12 V.
 Slip ring O.D. 28 mm
 Terminals L-S
 W/ battery sensing

Volt setting 28.5 V.

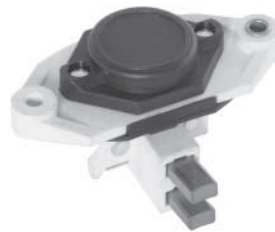

138293

Replacing 1197 311 323
Servicing 0120 469 102
 24 V.
 Slip ring O.D. 28 mm
 Gasket: Cargo 136435



138925

Replacing 1197 311 509
Servicing 0123 315 007, -020
 12 V.
 Slip ring O.D. 14 mm



138287

Replacing 1197 311 503
Servicing 0123 115 009, -014
 12 V.
 Slip ring O.D. 14 mm

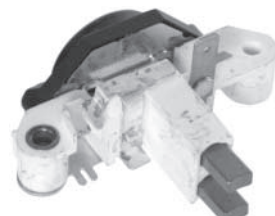

138310

Replacing 1197 311 511
Servicing 0123 505 017, 0123 510 007,
 -008, -028, 0123 515 003, -008, -009,
 -011, -012, -024, 0123 520 003, -004
 12 V.
 Slip ring O.D. 14 mm

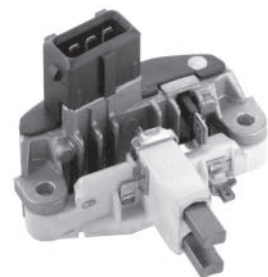

138999

Replacing 1197 311 545
Servicing 0123 315 013, 0123 325 010,
 0123 515 002, -004, -007, -010, -022,
 -023, -025, -030
 12 V.
 Slip ring O.D. 14 mm

Replacing BOSCH

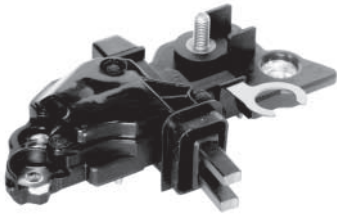

139044

Replacing F00M 145 201, -231
Servicing 0124 215 001, -003, 0124 225 001, -002, -004, -009, 0124 415 002, -005, -008, -010, 12 V.
 Slip ring O.D. 14 mm

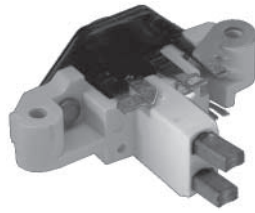

139854

Replacing 1197 311 540
Servicing 0123 100 003, 0123 110 008, 0123 500 009, 0123 510 069
 12 V.
 Slip ring O.D. 14 mm



139933

Replacing F00M 145 206, -240
Servicing 0124 225 010, -011, 0124 325 006, -007, 0124 515 020, -021
 12 V.
 Slip ring O.D. 14 mm

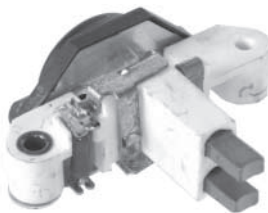

139251

Replacing 1197 311 529
Servicing 0123 515 013, -028
 12 V.
 Slip ring O.D. 14 mm
 W/ resistor 68 Ohm

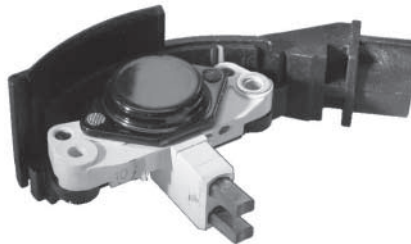

139872

Replacing 1197 311 510
Servicing 0123 325 002, -012, -014
 12 V.
 W/ battery sensing
 Slip ring O.D. 14 mm



Volt setting 28.5 V.

230006

Replacing 1197 311 316
Servicing 0120 689 552, -562, -566
 24 V.
 Slip ring O.D. 32 mm

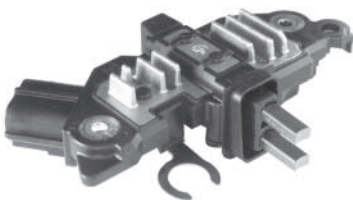

139334

Replacing F00M 145 214
Servicing 0124 415 006
 12 V.
 Slip ring O.D. 14 mm

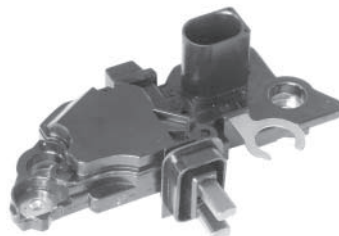

139925

Replacing F00M 145 200, -225, -237
Servicing 0124 215 008, 0124 225 032, 0124 315 010, -014, -021, -022, 0124 325 001, -002, -003, -004, -011, -012
 12 V.
 Slip ring O.D. 14 mm



Volt setting 29 V.

230007

Replacing 1197 311 325
Servicing 0120 689 559, -584
 24 V.
 Slip ring O.D. 28 mm

Replacing BOSCH



230200

Replacing 1197 311 034
Servicing 0120 468 028, -055
 12 V.
 Slip ring O.D. 28 mm



230455

Replacing 1197 311 032
Servicing 0120 484 011, -018, -022, -024, -025, -026, -027, -134, -138, -205, -285, -293, -299
 12 V.
 Slip ring O.D. 28 mm



230994

Replacing F00M 145 230, -352
Servicing 0124 515 019
 12 V.
 Slip ring O.D. 14 mm

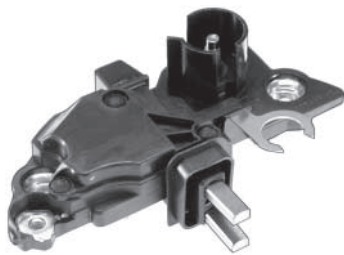

230249

Replacing F00M 145 220
Servicing 0124 215 001, -002, -003, -004, -005, 0124 225 016, -026, -027, 0124 325 009, -028, 0124 415 011, -012
 12 V.
 Slip ring O.D. 14 mm

Volt setting 40 V.



230456

Replacing 1197 311 103
Servicing 0120 468 127, -128
 36 V.
 Slip ring O.D. 28 mm

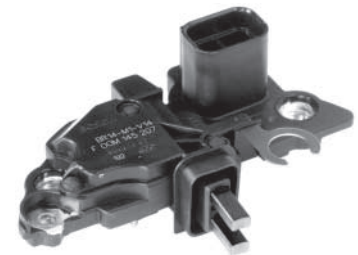

231130

Replacing F00M 145 207
Servicing 0124 325 008, -010
 12 V.
 Slip ring O.D. 14 mm



230259

Replacing 1197 311 541
Servicing 0123 320 040, -046, -047, -049, -051, -058, -060, -061, -062, 0123 340 007
 12 V.
 Slip ring O.D. 14 mm

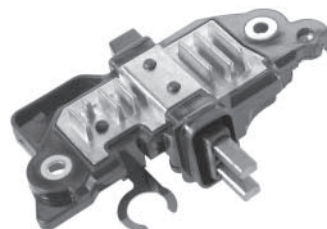

230624

Replacing F00M 145 239
Servicing 0124 415 014
 12 V.
 Slip ring O.D. 14 mm
Insulator plug: Cargo 238201



231237

Replacing 9191 067 043, -049, -059
Servicing 9120 060 043, 9120 061 100
 12 V.
 Terminals S-L
 Slip ring O.D. 28 mm

Replacing BOSCH



231523

Replacing F00M 145 267
Servicing 0124 555 003, 0124 655 003
 24 V.

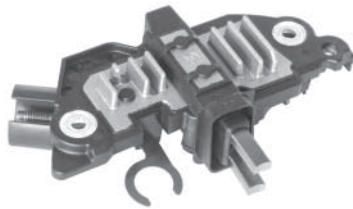

232193

Replacing F00M 145 252
Servicing 0124 615 002
 12 V.
 Slip ring O.D. 14 mm

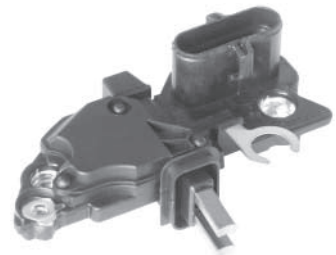

233117

Replacing F00M 145 246, -297
Servicing 0124 555 005, -006, -009, -010, -017, 0124 655 005, -006, -008, -012
 24 V.



231716

Replacing F00M 145 228, -283
Servicing 0124 415 009, -025, -026, 0124 515 032, -033, -095, -096
 12 V.



232197

Replacing 1197 311 508, -525
Servicing 0123 315 008, -015, -017, -018, -019
 12 V.
 Slip ring O.D. 14 mm



233372

Replacing 1197 311 230
Servicing 0123 115 012, -013
 12 V.
 Slip ring O.D. 14 mm



231758

Replacing 1197 311 033
Servicing 0120 484 001, -015, -017, -021, -185, -209, 6033 GB2 009
 12 V.

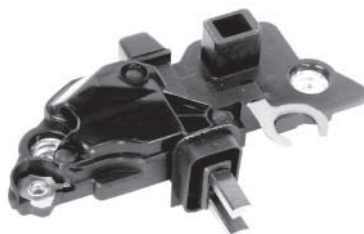

232927

Replacing F00M 145 229
Servicing 0124 515 014, -017, -054, 0124 525 001
 12 V.
 Slip ring O.D. 28 mm



233508

Replacing F00M 145 255
Servicing 0124 315 019, -027, 0124 415 016, -030, -032, 0124 525 021
 12 V.
 Slip ring O.D. 14 mm

Replacing BOSCH

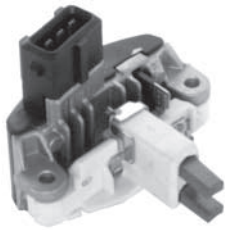

233568

Replacing 1197 311 547
Servicing 0123 315 022, 0123 325 011
 12 V.
 Slip ring O.D. 14 mm

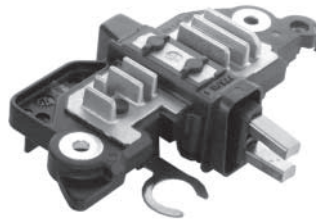

233729

Replacing F00M 145 248
Servicing 0124 325 039, 0124 515 064,
 -114, 0124 615 019, -033, 0124 625 020
 12 V.
 Slip ring O.D. 14 mm



234038

Replacing F00M 145 258
Servicing 0124 325 062, -072
 12 V.
 Slip ring O.D. 14 mm

Volt setting 14.4 V.

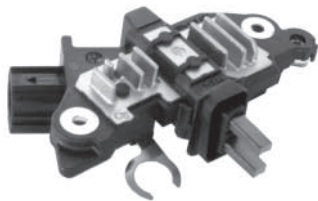

233587

Replacing F00M 145 236
Servicing 0124 315 015, -016, -024, -025,
 0124 325 071, -079, -085, -086
 12 V.
 Slip ring O.D. 28 mm



233774

Replacing 9190 087 005, 2Y5713
Servicing Caterpillar
 12 V.



234090

Replacing 9190 067 200
Servicing Harley Davidson
 Ceramic hybrid construction, chrome
 12 V.
 Regulator/rectifier



233632

Replacing 0192 900 007
 24 V.
 Overvoltage protection



233864

Replacing 1197 311 532
Servicing 0123 325 008
 12 V.
 Slip ring O.D. 14 mm



234112

Replacing 1197 311 543
Servicing 0123 500 520, 0123 525 500,
 -502, -503
 28 V.
 Slip ring O.D. 14 mm

Replacing BOSCH

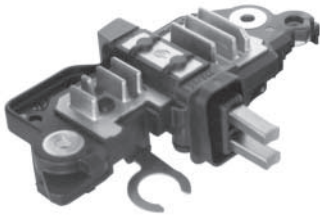

234263
Replacing F00M 145 251
Servicing 0124 515 050
 12 V.
 Slip ring O.D. 14 mm

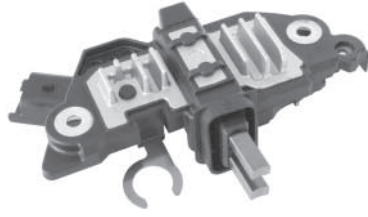

234770 
Replacing F00M 145 286, -394
Servicing 0120 525 035, 0124 525 034
 12 V.
 Slip ring O.D. 14 mm



234783 
Replacing 2127 311 001
Servicing 0120 389 567
 24 V.
 Slip ring O.D. 32 mm



234522
Replacing 1197 311 558
Servicing 0123 325 500, -501
 24 V.
 Slip ring O.D. 16 mm

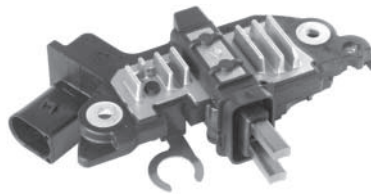

234771 
Replacing F00M 145 266, -365
Servicing 0124 625 002, -004, -019
 12 V.
 Slip ring O.D. 14 mm

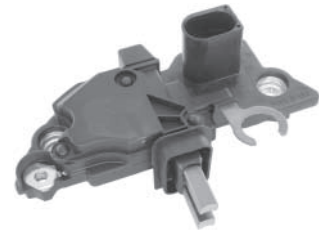

235156 
Replacing F00M 145 331, -382
Servicing 0124 615 012, -020, -024,
 0124 625 005, -007
 12 V.

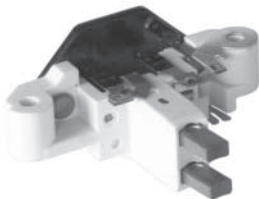

234630
Replacing 1197 311 222
Servicing 0123 320 112
 12 V.

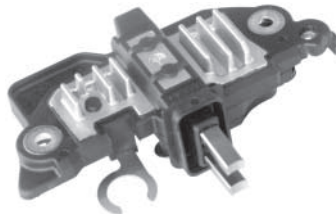

234779 
Replacing F00M 145 257, -362
Servicing 0124 225 029, -033, -034, -036,
 -045, -112, -113, -114, -144, 0124 515 049,
 -080, -082, -089, -109, -112, 0124 525 013,
 12 V.
 Slip ring O.D. 14 mm

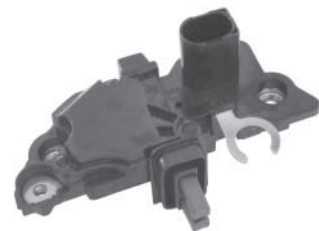

235207 
Replacing F00M 145 247
Servicing 0124 325 040, 0124 325 045,
 0124 325 108, 0124 325, 158,
 0124 515 047, 0124 515 048, 0124 515 055,
 0124, 515 060, 0124 615 013
 12 V.

Replacing BOSCH

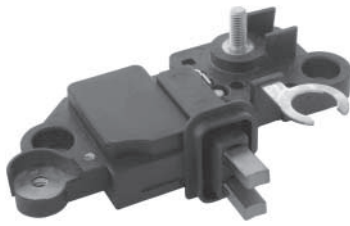

235273

Replacing F00M 145 271 366
Servicing 0124 525 016
 12 V. 140 Amp.
 Slip ring O.D. 16 mm



236717

Replacing F00M 145 276, -368
Servicing 0124 525 028, -043, -044, -047,
 -070, -076, -082
 12 V.



237736

Replacing F00M 145 374
Servicing 0124 625 014, -015
 12 V.



236002

Replacing F00M 145 289
Servicing 0124 325 087
 12 V.
 Slip ring O.D. 14 mm

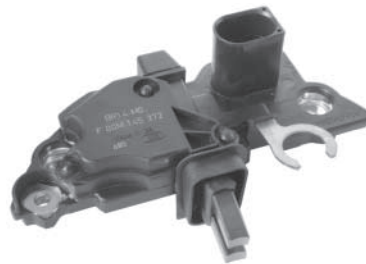

236820

Replacing F00M 145 372
Servicing 0124 625 006
 12 V.

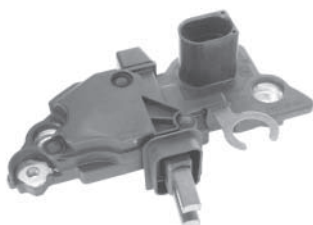

236714

Replacing F00M 145 280
Servicing 0124 515 105
 12 V.

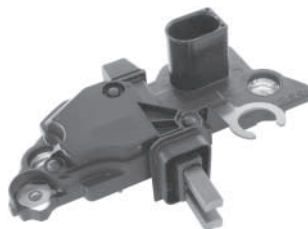

237270

Replacing F00M 145 272, -293, -367, -385
Servicing 0124 515 088, 0124 615 022,
 -028, 0124 625 017, -022
 12 V.



Replacing BOSCH

Regulator Parts



132578 Std pkg 5
Replacing 1121 015 003
 Gasket for brush holder 1197 336 010,
 Cargo 130697



136435 Std pkg 5
Replacing 1190 591 104
 Gasket for regulators 1197 311 032, -033,
 -044, -045, -310, -313, -314, -323,
 9191 339 310, Cargo 132666, 132903,
 136433, 137723, 138292, 138293



136823 Std pkg 5
Replacing 1121 015 015
Servicing 0120 468 054, 0120 469 549,
 -634, -673, -797, 0120 484 011
 Gasket for regulator



137361 Std pkg 10
 Cover for regulator
 Press fit



138294
Replacing 1190 591 095
Servicing 0120 469 100, -102, -103, -110,
 -113
 Cover for regulator



238201 
Servicing F00M 145 239, -387,
 Cargo 230624
 Insulator plug

Rectifiers



130594
Replacing 1127 320 342
Servicing 0120 300 530, -531, -536, -537,
 -538, -539, 9120 143 000, -006



130596
Replacing 1127 320 327, 9121 140 549
Servicing 0120 300 518, -519, -522, -523,
 -524, -528, -529, -532, -533, -540, -545,
 -546, -547, -548, -549, -550, -551, -558,
 -559, -563, -564, -587, -588,
 0120 339 502, -503, -504, -509, -510, -517



130597
Replacing 1127 320 152
Servicing 0120 300 516, -523, -568, -569,
 -592

Replacing BOSCH



130602 HD

Replacing 1127 011 120, -125
Servicing 0120 400 740, -741, -828, -832, -850, -855, -921, -922, -928, 0120 489 073, -637, -660, -668, -875, -882



131559 HD

Replacing 1127 011 116
Servicing 0120 489 080, -081, -083, -186, -209, -211, -250, -961, -967, -972, -973, -975, -976, -977, -978, -979, -981
 W/ terminal W



132667 HD

Replacing 1127 320 664, -665, -666, -934
Servicing 0120 488 138, -206, -218, -267, -294, -368, -370, -377, -379, -425, -435, -437, -438, -444, -445, 6033 G20 04B
 W/ terminal W,
 B+ terminal M8, D+ terminal M5



130603 HD

Replacing 1127 011 115
Servicing 0120 400 705, -758, -767, -811, -814, 0120 489 501, -503, -509, -511, -513, -522



132103

Replacing 1127 320 700
Servicing 0120 469 632, -633, -635, -636, -672, -697, -698, -699, -700, -708, -712, -716, -720



132668 HD

Replacing 1127 320 601
Servicing 0120 489 311, -312, -365, -366, -371, -373, -380, -381, -433, -440, -443
 B+ terminal M8
 D+ terminal M5



131468

Replacing 1127 011 095
Servicing 0120 489 728, -730, -827, -886, -944



132127

Replacing 1127 320 531, -538, -542
Servicing 0120 450 004, 0120 469 500, -501, -510, -511, -515, -524, -525, -534
 14 diodes
 NOTE: 14 diode rectifier can be used in 12 diode applications



132669 HD

Replacing 1127 011 139, 1127 320 580
Servicing 0120 489 047, -048, -075, -088, -091, -103, -176, -245, -267, -287, -288, -290, -291, -314, -957, -959
 W/ terminal W M5

Replacing BOSCH



132670

Replacing 1127 320 316, -569
Servicing 0120 300 552, -562, -575, -576, -577, -578, -579, -580, -585, -586, -589
 B+ terminal M6
 For alternators with sealed slip ring space



133260

Replacing 1127 320 370
Servicing 0120 450 009, 0120 469 564, -568, -628, -664, -668, -670, -681
 B+ terminal M6



133995

Replacing 1127 320 909, -992
Servicing 0120 488 256, 0120 489 316



132830

Replacing 1127 320 516
Servicing 0120 469 545, -546, -547, -548, -606, -607
 14 diodes. W/ terminal W
NOTE: 14 diode rectifier can be used in 12 diode applications



133261

Replacing 1127 320 369, -565, -581, -607
Servicing 0120 468 108, -134, 0120 469 517, -530, -531, -570, -571, -572, -571, -572, -573, -574, -594, -595
 O.D. 120 mm, 14 diodes, w/ terminal W
 B+ terminal M8



133996 HD

Replacing 1127 320 651, -677
Servicing 0120 488 156, -157, -158, -159, -160, -161, -163, -164, -165, -167, -168, -169, -170, -171, -172, -173, -174, -175, -190, -191, -192, -193, -200, -201, -202, -203, -204



133138

Replacing 1127 011 098, 1127 320 545
Servicing 0120 489 027, -053, -192, -230, -387, -388, -684, -702, -707, -723, -726, -727, -733, -757



133994

Replacing 1127 320 668
Servicing 0120 488 125, 0120 489 156, -643, -703, -704



133997 HD

Replacing 9121 147 302
Servicing 0120 488 000, -001, -002, -003, -004, -005, -008, -009, -010, -011, -012, 9120 144 605, -606, -609, -610, -611, -613, -614, -617, -618, -621, -622, 9120 334 628

Replacing BOSCH

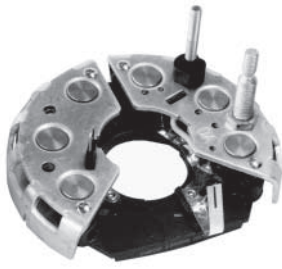

133998 HD
Replacing 1127 320 914
Servicing 0120 488 186, -187



134003
Replacing 1127 320 708
Servicing 0120 469 603, -610, -663, -723, -724, -734, -735, -736, -737, -738, -739, -740, -741, -768, -774, -813, -814, -831, -856, -857, -884, -903, -904, -930, -932, -934, -953, -975, -977, -991



134911
Replacing 1127 319 659, 1127 320 809
Servicing 0120 485 015, 0123 310 016



134001
Replacing 1127 320 704
Servicing 0120 469 646, -647, -666, -710, -836



134341 HD
Replacing 1127 011 131
Servicing 0120 489 070, -183, -286, -294, -475, -481



135438
Replacing 1127 319 605, 1127 320 840
Servicing 0120 335 016, -007, -011, -012



134002
Replacing 1127 320 706, -707
Servicing 0120 469 656, -657, -658, -660, -661, -662, -713, -747, -748, -781



134609
Replacing 1127 320 590, -976, -977
Servicing 0120 469 643



135439
Replacing 1127 319 667, 1127 320 850
Servicing 0120 485 036, -038, -039, 0123 320 001, -002, -005, 0123 340 002, -003, -005

Replacing BOSCH

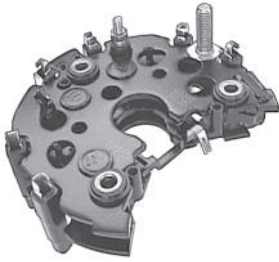

135440

Replacing 1127 320 856, 1127 319 015
Servicing 0120 485 025, -026,
 0123 310 004, 0123 320 004, -022,
 0123 345 004

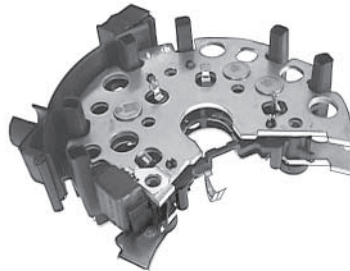

135528

Replacing 1127 319 033, -580, -715
Servicing 0123 212 001



135605

Replacing 1127 319 031, -637
Servicing 0120 465 003, -004, -013, -014



135444

Replacing 1127 320 870, 1127 319 584
Servicing 0120 485 029, 0123 310 014,
 -015, -029, 0123 320 014



135546

Replacing 1127 319 021, -673
Servicing 0120 485 032, -046,
 0123 114 005, -032, 0123 310 007,
 0123 320 048



135609

Replacing 1127 320 733
Servicing 0120 468 057, -058, -059, -060



135448

Replacing 1127 320 164
Servicing 0120 489 565, -566



135549

Replacing 1127 319 512, -649, -740
Servicing 0123 510 017, 0123 545 001,
 -002, -003



135633

Replacing 1127 320 683
Servicing 0120 488 115, -120, -121, -122,
 -489 396, -451, -452

Replacing BOSCH

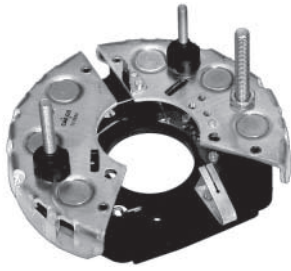

135890

Replacing 1127 319 113, 1127 320 667
Servicing 0120 488 211, -228, -286,
 0120 489 346, -347, -389, -390, -391, -
 392, -408



136434

Replacing 1127 319 104
Servicing 0120 488 283



136485

Replacing 1127 320 734
Servicing 0120 469 004, -006, -007, -968,
 -969, -973, -984, -985



136051

Replacing 1127 319 019
Servicing 0120 485 020, -023,
 0123 320 003, 0123 340 001



136469

Replacing 1127 319 663, 1127 320 846
Servicing 0120 335 008, 0123 115 010,
 -011



136556

Replacing 9121 067 379
Servicing 9120 060 027, Thermo King
 O.D. 114 mm, 8-40 Amp. diodes
 W/o diode trio
 B+ terminal M6 x 33 mm



136372

Replacing 1127 320 727
Servicing 0120 469 878 -879, -913, -914



136482

Replacing 1127 319 005, -601, -766
Servicing 0123 110 005, 0123 120 001



136581

Replacing 1127 320 547, -550, -571, -973
Servicing 0120 689 503, -504, -505, -506,
 -507, -508, -510, -511, -512, -513, -514
 W/ terminal W
 140 Amp.
Terminal W only: Cargo 233089

Replacing BOSCH



136591

Replacing 9121 067 394
Servicing 9120 060 009, -023
 Thermo King
 W/ terminal W
 B+ terminal M6



136826

Replacing 1127 320 743
Servicing 0120 468 080, -081, -084, -085, -086, -119, -120



136837

Replacing 1127 319 109, 1127 320 913
Servicing 0120 484 002, -003, -016, -017, -018, -019, -021, -027, 6033 GB2 009



136703

Replacing 1127 319 522, -607, -694
Servicing 0123 310 010, -011, -012, -013



136831

Replacing 1127 319 013, -597, -778
Servicing 0123 505 001, -004, 0123 510 003, -020, -052



136838

Replacing 1127 319 530, -599, -726
Servicing 0123 100 001, -002



136737

Replacing 1127 320 954
Servicing 0120 468 028, -055



136832

Replacing 1127 320 970, -971, -989, -990
Servicing 0120 468 037, -053, -107, -113, -114, -115, -118, -131, -137, -149, 0120 469 013, -895, 6033 GB3 006, -008, -033, -034, -054



136861

Replacing 1127 319 011, -560
Servicing 0120 485 047, 0123 310 022, -027, -031, -043, -044, -047, -050, 0123 315 003, -500, -502, -503, 0123 320 009, -016, -021, -025, -026, -028, -052, -053, -054, -055, -066

Replacing BOSCH



136957

Replacing 1127 319 003, -645
Servicing 0120 465 006, -007, -008, -012, -018, -023, -029, 0123 213 005, -006, -007, 0123 505 007, -008, -009



137258

Replacing 1127 319 538 -574, -736
Servicing 0123 500 013, 0123 510 047, 0123 515 018, -020, -021



137333

Replacing 1127 319 593, 1127 320 807
Servicing 0120 485 011, -012, -022, 0123 320 029, -044, -045, 0213 315 005



137030

Replacing 1127 320 906
Servicing 0120 484 004, -005, -006, -009, -010, -013, -014



137259

Replacing 1127 319 690
Servicing 0120 465 031, 0123 214 002



137380

Replacing 9122 337 307
Servicing 9120 334 631, -632



137257

Replacing 1127 319 009, -623
Servicing 0123 310 006, 0123 315 004, 0123 320 012



137260

Replacing 1127 320 717, -726, 935
Servicing 0120 468 063, -064, -077, -078, -102, -103, -104, -105, -110, -111, 0120 469 869, -877
 6 - 35A Diodes
 O.D. 120 mm.



137507

Replacing 1127 319 570
Servicing 0120 310 023, -048, 0123 320 050

Replacing BOSCH



137508

Replacing 9122 337 303
Servicing 9120 334 317, -318



137726

Replacing 1127 320 903
Servicing 0120 488 146, -147, -148, -149, -150, -179, -180, -181, -243



138076

Replacing 1127 319 035, -635, -710
Servicing 0123 510 004, -018, -021, -060, -074, -075



137604

Replacing 1127 319 684
Servicing 0120 465 026, -028, 0123 510 029, -030



138074

Replacing 1127 319 576, 1127 320 854
Servicing 0120 465 020, -021, 0123 505 005, 0123 510 001, -026, -027, -034

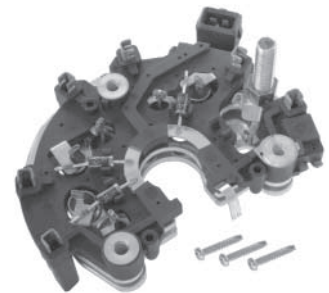

138077

Replacing 1127 319 552, 1127 320 852
Servicing 0120 485 034, -043, -044, 0123 310 002, -003, -024, -025, -032, 0123 315 002, 0123 320 017, -019



137724

Replacing 1127 320 750
Servicing 0120 469 100, -102, -103, -107, -108, -109, -110, -111, -112, -113, -114, 6033 GB3 009, -047, -055



138075

Replacing 1127 319 022, -615, -704, -786
Servicing 1123 325 002, -003, -012, -013, -014



138078

Replacing 1127 319 554
Servicing 0123 315 016, -021

Replacing BOSCH



138079

Replacing 1127 319 558, -562
Servicing 0123 510 023, -038, -039, -044, -049, -050, -051, -058, -059, -066, -067, -072, -080, 0123 512 500



138084

Replacing 1127 320 901, -912, -918, -938
Servicing 0120 468 013, -014, -032, -048, -049, -071, -072, -073, -074, -097, -098



138288

Replacing 1127 319 504, -669
Servicing 0123 115 009, -014



138080

Replacing 1127 319 568, -732
Servicing 0123 510 031, -033, -041, -045, -061, -070, -071, -088, -091, 0123 515 003, -008, -009, -011, -012, -024



138164

Replacing 1127 320 712, -735
Servicing 0120 469 784, -785, -786, -787, -793, -882, -883, -910, -915, -924



138289

Replacing 1127 319 722
Servicing 0123 110 007



138081

Replacing 1127 319 631
Servicing 0123 520 002, -005



138165

Replacing 1127 320 692
Servicing 0120 484 001, -002, -003, -011, -012, -015, -016, -017, -018, -020, -022
 O.D. 114 mm, B+ terminal M8 x 30 mm,
 D+ terminal M5 x 25 mm
 W/ diode trio, w/ terminal W



138620

Replacing 1127 320 713
Servicing 0120 468 009, 010, -011, -012, -015, -016

Replacing BOSCH



138987

Replacing 1127 320 718, -719
Servicing 0120 450 011, -012, -013, -016, -017, Chrysler
 B+ terminal M8 /M6 x 46 mm
 O.D. 120 mm
 W/o diode trio



139252

Replacing 1127 319 643, -692
Servicing 0123 515 002, -004, -007, -010



139571

Replacing 1127 319 671
Servicing 0123 315 020
 Honda



139028

Replacing 1127 320 744
Servicing 0120 468 082, -83, -122



139253

Replacing 1127 320 729
Servicing 0120 450 018, -019, -020, -021, -022, -023, -024, -025, -026, -028, -029, -030, -031
 B+ terminal M8 /M6 x 42 mm
 W/o diode trio



139581

Replacing 1127 320 390, -959, -961, -995
Servicing 0120 450 015, 0120 469 038, -518, -519, -520, -521, -522, -523, -526, -540, -562, -569, -579, -585, -592, -652, -653, -692, -749, -752, -761, -763, -772
 W/ terminal W



139030

Replacing 1127 319 514, -564, -698
Servicing 0123 315 008, -015, -017, -018



139426

Replacing 1127 320 397, -503
Servicing 0122 469 001, -002, -003, -004, -005
 W/ terminal W



139915

Replacing F00M 113 200
Servicing 0124 225 001, -002, -004, -009, -023, -024, -025, -026, -027

Replacing BOSCH



139921

Replacing F00M 133 201
Servicing 0124 515 010, -011, -012, -013, -017, -019, -020, -021, -022, -024, -025, -026, -027, -034, -038, -039, -054
 O.D. 120 mm

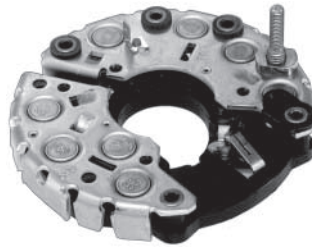

139996

Replacing 9121 337 072
Servicing 9120 335 000, -001



230093

Replacing 1127 319 572, -734
Servicing 0120 510 053, -054, -056, -065, 0120 515 016



139939

Replacing 1127 319 712
Servicing 0123 515 022, -023, -025, -030



230075

Replacing F00M 123 200, -201
Servicing 0124 225 010, 0124 315 001, -002, -003, -004, -005, -006, -007, -008, -010, -011, -013, -014, 0124 320 001, 0124 325 001, -002, -003, -004, -011, -012
 B+ terminal M8



230124

Replacing 1127 319 661, -748
Servicing 0123 325 005, -006



139944

Replacing 1127 319 764
Servicing 0123 110 006, -008



230092

Replacing 1127 319 738
Servicing 0120 510 005, -006, -007, -032
 Honda



230173

Replacing 1127 319 501, -578, -752
Servicing 0123 505 011, -012, -013, -017

Replacing BOSCH



230174

Replacing 1127 319 655
Servicing 0123 510 009, -013, -014, -015, -028



230242

Replacing 1127 319 728
Servicing 0123 310 001, -018, -019, -020, -034, -035, -037, -038, -039, -040, -046, -049, 0123 320 007, -027 -031, -032, -034, -038, -063



230361

Replacing 1127 320 661, -662, -926
Servicing 0120 488 183, -184, -219, -220
 B+ terminal M8
 D+ terminal M5



230179

Replacing 1127 319 682, -788, -796
Servicing 0123 510 037, -106, -109
 B+ terminal M6
 D+ terminal M5



230358

Replacing 1127 320 721
Servicing 0120 469 827, -828, -829, -830, -918, -919
 B+ terminal M8
 D+ terminal M6



230374

Replacing F00M 133 207
Servicing 0124 515 035, -057
 O.D. 120 mm



230241

Replacing 1127 319 696, -714
Servicing 0123 510 073



230360

Replacing F00M 123 202
Servicing 0124 415 001, -002, -005, -006, -008, -009, -010
 O.D. 120 mm



230511

Replacing 1127 319 103
Servicing 0120 468 140, 0120 469 024, -036, -037, -053

Replacing BOSCH



230614

Replacing 1127 319 639
Servicing 0120 465 015, -016, -017,
 0123 500 001, 0123 545 004



230713

Replacing 1127 319 108
Servicing 0120 468 127, -128
 B+ terminal M8



230782

Replacing 1127 320 748
Servicing 0120 450 027

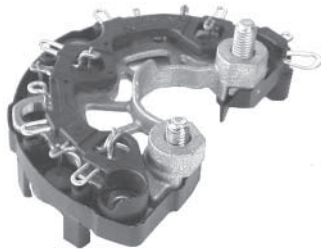

230622

Replacing F00M 123 204, -217
Servicing 0124 325 006, -007, -024
 O.D. 120.5 mm
 B+ terminal M8



230729

Replacing 1127 320 904, -968
Servicing 0120 469 041, -796, -963, -983
 O.D. 120 mm
 B+ terminal M8
 W terminal M5
 B- terminal M6



230783

Replacing 1127 319 762
Servicing 0123 100 003



230640

Replacing 1127 319 101, 1127 320 994
Servicing 0120 468 093, -135, -144,
 0120 469 018, -033, 6033 GB3 021
 B+ terminal M8
 W/ terminal W



230775

Replacing 1127 320 740
Servicing 0120 468 042, -043, -061, -062,
 -075, -076
 B+ terminal M8
 14 diodes

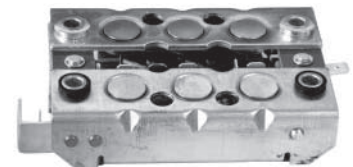

230988

Replacing 0197 002 003
Servicing 0120 340 001, -002, 003, -004,
 -005, -006, -008

Replacing BOSCH



231115

Replacing 1127 320 515
Servicing 0120 469 541, -542, -543, -544, -598, -599
 O.D. 120 mm
 B+ terminal M8
 W/ terminal W



231344

Replacing 1127 319 556, -587
Servicing 0123 505 014, -015, -016



231590

Replacing 1127 319 744
Servicing 0123 500 007, -008, -009, 0123 505 002, -003, 0123 510 043, -062, -063, -064, -089
 B+ terminal M8 x 22 mm



231118

Replacing 1127 320 359
Servicing 0120 469 502, -503, -504, -505, -528, -533, -551, -552, -553, -554
 O.D. 120 mm
 B+ terminal M8
 W/ diode trio



231451

Replacing 1127 320 753
Servicing 0120 468 143, -145, 0120 469 101, -115, -116, -117, 6033 G00 4BY, 6033 G3B 022, 6033 GB3 010, -019, -022, -023, -027

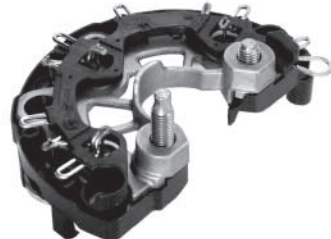

231592

Replacing F00M 123 203
Servicing 0124 415 013, -014



231218

Replacing 1127 320 517, -603
Servicing 0120 469 549, -634, -673, -679, -691, -849, -890
 B+ terminal M6
 D+ terminal M4
 B- terminal M6



231524

Replacing F00M 133 223
Servicing 0124 555 003, -005, -006, 0124 655 003, -005, -006



231643

Replacing 1127 319 802
Servicing 0123 510 108

Replacing BOSCH



231714

Replacing F00M 133 200
Servicing 0124 515 001, -004, -005, -006, -015, -016, -023, -031, -032, -033, -085, -086



233371

Replacing 1127 320 930
Servicing 0120 488 214, -215, 0120 489 467, -476

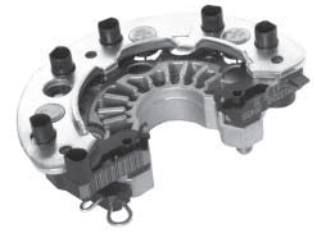

233469

Replacing F00M 133 208
Servicing 0124 615 002



231989

Replacing 1127 319 516, -613, -800
Servicing 0123 510 010, -011
 B+ terminal M8 x 36 mm
 D+ terminal M5 x 23 mm
 6 diodes, w/ diode trio



233465

Replacing F00M 113 208
Servicing 0124 225 011



233524

Replacing F00M 123 233
Servicing 0124 315 019, -027
 B+ terminal M6
 O.D. 120.5 mm



232172

Replacing 1127 320 701
Servicing 0120 469 601, -602, -604, -605, -637, -638, -654, -674, -675, -701, -702
 O.D. 120 mm, 8 diodes
 W/ terminal W
 B+ terminal M8



233467

Replacing F00M 123 228
Servicing 0124 325 022, -035



233561

Replacing F00M 123 211
Servicing 0124 415 011, -012

Replacing BOSCH



233718

Replacing 1127 319 677
Servicing 0123 510 048



233780

Replacing 1127 320 737
Servicing 0120 468 004, -005, -006
 O.D. 120 mm, w/ diode trio
 B+ terminal M8 x 33 mm
 D+ terminal M5 x 33 mm



234357

Replacing 1127 319 721
Servicing 0123 525 500, -502, -503
 O.D. 120 mm, 8 diodes
 B+ terminal M8



233778

Replacing 1127 320 705, -715, -723, -728
Servicing 0120 468 017, -018, -019, -020, -022, -025, -026, -027, -029, -052, -056
 O.D. 120 mm, 8 diodes
 B+ terminal M8 x 33 mm
 D+ terminal M5 x 20 mm



233923

Replacing 1127 319 771
Servicing 0120 520 017, -029
 O.D. 123 mm, 12 diodes
 B+ terminal M8 x 26 mm
 D+ terminal M5 x 13 mm

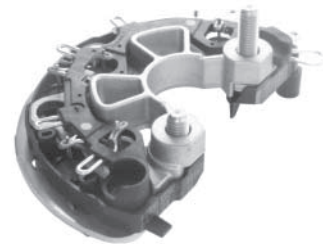

234424

Replacing F00M 133 206, -230, -248
Servicing 0124 515 028, 0124 525 010
 O.D. 130 mm, 6 diodes
 B+ terminal M8
 D+ terminal M8



233779

Replacing 1127 320 716
Servicing 0120 469 788, -789
 B+ terminal M6/8
 W/ diode trio
 W/ terminal W



234333

Replacing 1127 319 794
Servicing 0123 525 501
 O.D. 123 mm, 8 diodes
 B+ terminal M8 x 12 mm

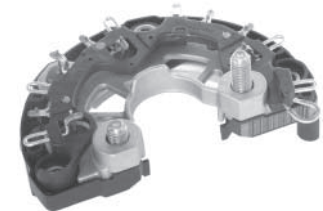

234775

Replacing F00M 113 207
Servicing 0124 225 016
 B+ terminal M8 x 16 mm



Replacing BOSCH



234782

Replacing F00M 123 216
Servicing 0124 320 002, 0124 325 052
 B+ terminal: M8 x 20 mm



234953

Replacing 9121 067 067, -364, -371, -374
Servicing 9120 060 009, -023, -038
 O.D. 114 mm, 8-40 Amps. diodes
 W/ terminal W
 B+ terminal: M8 x 30 mm



235053

Replacing F00M 123 215
Servicing 0124 325 009, -058, -145
 B+ terminal: M8 x 25 mm



234792

Replacing 1127 011 186
Servicing 0120 488 252, -253, -266
 B+ terminal: M8 x 31 mm
 D+ terminal: M4 x 19 mm

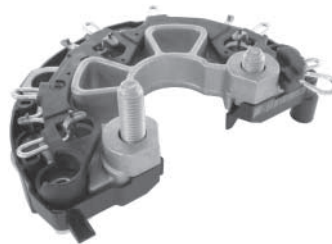

235051

Replacing F00M 133 224, -286
Servicing 0124 555 001, -002, -004, -007, -008, -011, -012, -015, -021, -022, -023, -025, 0124 655 001, -002, -004, -007, -016
 O.D. 121 mm
 B+ terminal: M8 x 20.6 mm



235057

Replacing 9121 337 093
Servicing 6033 GB5 007, -009, 9120 335 002
 B+ terminal: M6 x 25.5 mm
 D+ terminal: M5 x 23 mm



234839

Replacing 1127 319 782
Servicing 0123 515 500, -501, -503
 B+ terminal: M8 x 25.5 mm
 D+ terminal: M5 x 15 mm



235052

Replacing F00M 123 234
Servicing 0124 415 016, -030, -032
 B+ terminal: M6 x 19.5 mm



235218

Replacing F00M 133 218, -247
Servicing 0124 515 049, 0124 525 001, -008, -009, -010, -013, -014, -016, -027, -029, -060, -061, -074, -087, -088, -089, -090, -093, 0124 615 006, -007, -008, -009, -012, -013, -014, -015, -019, -020, -022
 B+ terminal: M8 x 20 mm



Replacing BOSCH



236821

Replacing F00M 133249

Servicing 0124 625 001, -003, -005, -006, -007, -020, -022, -024, -025, -032

O.D. 130 mm. 6 diodes

W/ terminal W

B+ terminal: M8 x 21 mm



237268

Replacing 1127 319 700

Servicing 0123 520 003, -004, -006, -007, -008, -010, -011, -012, -013, -014, -019, -020, -021, -022, -023, -026, -027, -031



Rectifier Parts



133373 Std pkg 10 **A**

M8 x 51.5 mm

B+ terminal



232601 Std pkg 5

M8-1.25 x 29 mm / M6-1.0 x 18 mm

B+ terminal



133374 Std pkg 10 **A**

M8 x 48 mm

B+ terminal



232602 Std pkg 5

M8-1.25 x 51.5 mm

B+ terminal



139326

M6 / M8 x 38 mm

B+ terminal



232603 Std pkg 5

M5-0.8 x 49.5 mm

B+ terminal



230512

M6 x 50 mm

B+ terminal



135319

Servicing Cargo 131468, 133138, 133995
Insulation kit

Replacing BOSCH

Also see Diode Chapter
page 780



233100 Std pkg 5

Servicing 0120 450 011, -012, -014, -018, -019, -020, -021, -022, -023, -024, -025
I.D. 8 mm
Insulator for rectifier



234464

O.D. 18.8/22.5 mm, I.D. 8 mm, W. 8.8 mm,
O.D. 12.07 mm, I.D. 4 mm, W. 9.75 mm
Insulators



233089 Std pkg 5

Servicing 1127 320 547, -550, -571, -973,
Cargo 136581
3.3 Ohm
W-terminal
Part of terminal kit 1127 011 083:
Cargo 231814



136017

Replacing 1121 015 011
Servicing 0120 689 502, -503, -504, -505,
-506, -507, -508, -510, -511, -512, -513,
-514, -515, -516, -517, -518, -520, -521
Gasket for rectifier

Diode Trios

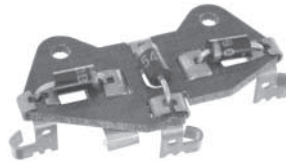

131095

Replacing 1121 099 007
Servicing 0120 400 600, -605, -611, -620,
-629, -631, -632, -633, -634, -643, -644,
-650, -665, -702, -708, -714, -716, -717,
-721, -725, -726, -752, -787, -793, -794,
-848, -895

Diodes



131294 Std pkg 10 A

3 Amp. 1000 V.



234350 Std pkg 10

50 Amp. Avalanche
12.8 mm press fit
32-40 V.
Negative



234351 Std pkg 10

50 Amp. Avalanche
12.8 mm press fit
32-40 V.
Positive



236252 Std pkg 10

Replacing 0270 300 113
Servicing 0123 310 010
65 Amp. Avalanche
13 mm press fit
19-25 V.
Positive

Also see Diode Chapter
page 780

Replacing BOSCH



236253 Std pkg 10 
Replacing 0270 300 114
Servicing 0123 310 010
 65 Amp. Avalanche
 13 mm press fit
 19-25 V.
 Negative

Slip Rings



133401 Std pkg 10 **A**
Replacing 1124 304 007
 O.D. 32 mm, Shaft 17 mm, L. 22.3 mm
 W/ 1.8 mm copper
Quick repair: Cargo 135659



136465
Replacing 2124 306 001
Servicing 0120 600 588, -590, -591,
 0120 689 519, -529, -536, -537, -544, -547
 O.D. 40.5 mm, Shaft 25 mm, L. 38 mm



133402 Std pkg 10 **A**
Replacing 1124 303 001, -013
Servicing 0120 484 012, -015,
 0120 489 032, -726
 O.D. 28 mm, Shaft 17 mm, L. 22.1 mm
 W/ 1.8 mm copper
Quick repair: Cargo 135660



135659 Std pkg 10
Servicing Cargo 133401
 30 / 34 x 8.5 mm
 Copper ring
Quick repair for slip ring: Cargo 133401



135172 Std pkg 5 **A**
Servicing 0120 465 . . . , 485 . . .
 O.D. 16 mm, Shaft 7 mm, L. 52.1 mm
 Alternators w/ internal fan



135660 Std pkg 10
Servicing Cargo 133402
 26 / 30 x 8.5 mm
 Copper ring
Quick repair for slip ring: Cargo 133402



136000
Replacing 1124 304 018
Servicing 0120 689 ...
 O.D. 32.7 mm, Shaft 20 mm, L. 22.3 mm

Replacing BOSCH

Brush Boxes



130692

Replacing 1124 336 075
Servicing 0120 400 633, -668, -684, -690, -698
 24 V. Complete w/ brushes

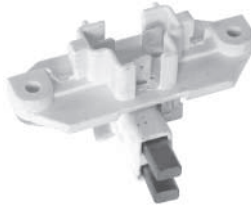

130697

Replacing 1194 336 010
Servicing 0120 300 540, -551, -559
 12 V. Complete w/ brushes



138754

Replacing 1194 336 038
Servicing 0120 450 012, -014, -016, 017
 12 V. Complete w/ brushes

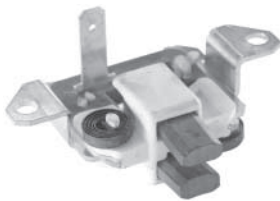

130693

Replacing 1124 336 042
Servicing 0120 400 605, -709, -920
 12 V. Complete w/ brushes



133170

Replacing 1124 336 055, -057
Servicing 0120 400 617, -632, -639, -640, -641, -642, -645, -664, -673, -674, -688
 24 V. Complete w/ brushes

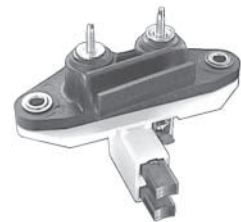

139005

Replacing 1194 336 053
Servicing 0120 450 019, -020, -022, -023, -024, -025, -026, -027, -028, -029, Chrysler
 12 V. Complete w/ brushes

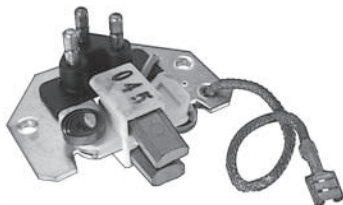

130694

Replacing 1124 336 045
Servicing 0120 400 608, -609, -611, -648, -693
 12 V. Complete w/ brushes

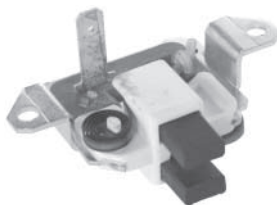

133172

Replacing 1124 336 070
Servicing 0120 400 695, -708, -720, -887, -905
 24 V. Complete w/ brushes



232731

Replacing 1194 336 035
Servicing 0120 400 944, -945
 12 V. Complete w/ brushes



130696

Replacing 1124 336 047
Servicing 0120 400 602, -603, -615, -621, -623
 12 V. Complete w/ brushes

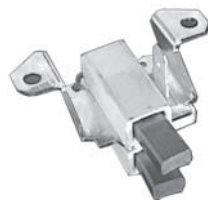

133179

Replacing 1124 336 049
Servicing 0120 300 510, -511, -512, -513, -514, -515, -516, -517, -543, -544, -555
 12 V. Complete w/ brushes

Replacing BOSCH

Brush Box Parts



135174 Std pkg 10 **A**
 Replacing 1124 652 000
 Servicing 0120 400 . . .
 Brush spring

Brush Sets



BX182 2 Std pkg 10 **A**
 Replacing 1127 014 009
 5 x 10 x 17 mm
 12 V.



BX202 2 Std pkg 10 **A**
 Replacing 1127 014 017
 5 x 8 x 19 mm
 24 V.



BX185 2 Std pkg 10 **A**
 Replacing 1127 014 011
 5 x 8 x 15 mm
 12 V.



BX203 2 Std pkg 10
 Replacing 2127 014 003, -005
 5 x 10 x 22 mm
 24 V.



BX198 2 Std pkg 10 **A**
 Replacing 1127 014 014
 5 x 10 x 17 mm
 12/24 V.



BX204 2 Std pkg 10 **A**
 Replacing 1127 014 018
 5 x 8 x 19 mm
 12 V.



BX201 2 Std pkg 10
 Replacing 1197 014 016
 5 x 8 x 23.2 mm
 12 V.



BX206 2 Std pkg 10
 Replacing 2127 014 006, -007
 5 x 10 x 26.5 mm
 24 V.

Replacing BOSCH

Also see Bearing Chapter page 821



BX209 2
Replacing 1127 014 019, -021
 5 x 8 x 15.5 mm
 12 V.



BX220 2 
Servicing Compact alternators
 12 / 24 V.
 4 x 6 x 17.5 mm
 W/ spring and plastic part

Special Bearings



140105 Std pkg 14 **A**
Replacing 1900 905 282, 62201-LRSX
Servicing 0120 489 643, -921
 12/32 x 14 mm



BX210 2 Std pkg 10
Replacing 1127 014 032, -024
 5 x 8 x 17.5 mm
 12 V.



140116 Std pkg 10 **A**
Replacing 1120 900 002, 394737A
Servicing 0120 339 523, -528, -546
 12/28 x 12 mm



BX213 2 Std pkg 10 **A**
Replacing 1127 014 028
 4 x 6 x 17.5 mm
 12 V. / 24 V.



140176 Std pkg 10 **A**
Replacing 1120 900 008, -010, 365740BB1B
Servicing 0120 400 633, -664, -668, -701
 17/62 x 17.5 mm



BX215 2 Std pkg 10
Replacing 1127 014 026, -027
Servicing 0120 469 710, 0120 689 503
 5 x 8 x 24.2 mm
 12 V.



140263 Std pkg 10 **A**
Replacing 1120 905 012, 363226C
Servicing 0120 469 745, -746
 17/52 x 17 mm

Also see Bearing Chapter
page 783

Replacing BOSCH



140442 Std pkg 10 **A**
Replacing 62304-2RSI
 20/52 x 21 mm



140917
Replacing 1120 905 035, TM-623-22LLUC3
Servicing 0120 468 028, -054
 22/56 x 21 mm

Needle Bearings



140807 Std pkg 10 **A**
Replacing 1000 917 004
 10/14 x 14 mm



140569 Std pkg 6 **A**
Replacing 1120 905 005,
 TM-62304 LLUA/17
 17/52 x 21 mm



140957 Std pkg 8
Replacing 1120 905 097
 17/62 x 20 mm



140707
Replacing 2120 905 000, 62306 X1 LLUA
Servicing 0120 689 519, -520, -521, -522
 30/72 x 27 mm



141232 
Replacing 1120 905 510
 17/52 x 17 mm
 For use in alternators w/ Free wheel



140879 Std pkg 5
Replacing 1120 905 043, 62305-2RS-1C3
Servicing 0122 469 002, -005
 25/62 x 24 mm



141233 
Replacing 1120 905 502, F00M 990 410
 17/47 x 14 mm
 For use in alternators w/ Free wheel

Replacing BOSCH

Also see Bearing Chapter page 821

Roller Bearings



140515 A
 Replacing 1900 910 024, NU 202 ECP
 15/35 x 11 mm



140516 Std pkg 10 **A**
 Replacing 1900 910 032, NU 205 ECP
 25/52 x 15 mm



140816 Std pkg 10
 Replacing 2120 910 000
 20/47 x 14 mm

Fan & Pulleys



133874
 Replacing 1126 610 032, -047
 Servicing G1
 O.D. 127 mm, Bore 17 mm



133875
 Replacing 1126 610 045, -060, -078
 Servicing K1
 O.D. 135 mm, Bore 17 mm



134537
 Replacing 1126 610 065
 Servicing 0120 450 012, -016,
 0120 469 513, -517, -531, -549, -570, -
 572, -574, -576, -578, -593, -595, -618, -
 619
 O.D. 141 mm, Bore 17 mm



134538
 Replacing 1126 610 070
 Servicing 0120 400 952, 0120 468 003,
 -005, -006, -024, 0120 469 589, -591, -620,
 -642, -645, -683, -685, -695, -745, -746
 O.D. 141 mm, Bore 17 mm



136008
 Replacing 1126 610 052
 Servicing 0120 623 052, 0120 689 502,
 -503, -504, -505, -506, -507, -508, -510,
 -511, -512, -513, -514, -517, -518, -520, -522
 O.D. 210 mm, Bore 30 mm



136045
 Replacing 1126 610 113
 Servicing 0120 469 005, -906, -907, -911,
 -912, -969
 O.D. 146 mm, Bore 17 mm

Replacing BOSCH



136678

Replacing 1126 610 046
Servicing 0120 400 531, -534, -615, -625, -650, -657, -745, -747, -810, -906, -928
 O.D. 135 mm, Bore 17 mm
 Anti CW rotation



231282

Replacing 2126 610 033
Servicing 0120 689 599, -562, -567, -569, -570, -571, -572, -573, -574, -576, -577
 O.D. 210 mm, Bore 30 mm



234671

Replacing 1126 610 075
Servicing 0120 689 516, -524, -525
 O.D. 177 mm, Bore 30 mm



137256

Replacing 1126 610 114
Servicing 0120 468 105
 O.D. 154 mm, Bore 17 mm



231755

Replacing 1126 610 061
Servicing 0120 468 028, -054, -055, -136, -142, -147, 0122 469 002, -004, -005
 O.D. 165 mm, Bore 22 mm



230774

Replacing 1126 610 110
Servicing 0120 450 009, 0120 468 011, -012, -025, -026, -027, -091, -092, 0120 469 500, -502, -503, -504, -505, -510, -511, -520, -524, -525, -528, -534, -537
 O.D. 145 mm, Bore 17 mm

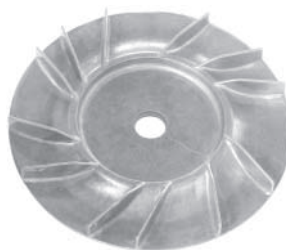

234017

Replacing 1126 610 108
Servicing 0120 468 143, -145, 6033 G00 4BY, 6033 GB3 010, -023
 O.D. 153 mm, Bore 17 mm

Replacing BOSCH

Also see Pulley Survey page 809



131048

Replacing Universal
O.D. 83.6 mm, Bore 17 mm,
Single, B-belt type



131200

Replacing 1126 600 488, -348
Servicing 0120 469 586, -599, -633, -677,
-698, -714, -724, -729, -739, -814,
0120 489 002, -003, -009, -013, -017, -081
O.D. 67.9 mm, Bore 17 mm, W. 49.3 mm,
Single w/ neck



131844

Replacing 1126 600 568
Servicing 0120 469 695, 0120 489 322,
-321
O.D. 49.6 mm, Bore 17 mm, W. 38.3 mm,
6 grooves



131193

Replacing 6033 GD 5113
Servicing 0120 300 550, -551,
0120 339 533, -534, 0120 400 604, -605,
-623, -625, -670, 0120 469 600, -607
O.D. 83.4 mm, Bore 17 mm, W. 21.3 mm,
Single



131201

Replacing 1126 600 381, -184, -254, -381
Servicing 0120 300 511, -513, -518, -519,
-530, -531, -533, -536, -537, -539, -560,
0120 339 525, 0120 400 605, -611, -619,
O.D. 71.8 mm, Bore 17 mm, W. 21.4 mm,
Single



131845

Replacing 1126 600 569
Servicing 0120 469 746, -853, -855, -884,
-897, 0120 488 126, -133, -136,
0120 489 324, -326, -332
O.D. 55.1 mm, Bore 17 mm, W. 37.7 mm,
6 grooves



131196

Replacing 6033 GD 5100
Servicing 0120 300 523, -540, -545, -546,
-547, -505, 0120 339 503, -506, -510,
0120 400 806, -807, -808, -809, -810, -872
O.D. 68.5 mm, Bore 17 mm, W. 21.7 mm,
Single



131203

Replacing 1126 600 259, -103
Servicing 0120 400 722, -723, -852, -853,
-909, -912, -913, -932, -933,
0120 489 065, -066
O.D. 76.2 mm, Bore 17 mm, W. 37.8 mm,
Double



131846

Replacing 1126 600 570
Servicing 0120 469 857, 0120 489 327,
-329, -333
O.D. 63.5 mm, Bore 17 mm, W. 37.8 mm,
6 grooves



131198

Replacing 1126 600 385, -168, -186
Servicing 0120 300 564, -586, -588,
0120 400 630, -631, -680, -730, -731,
-744, -745, -746, -747, -752, -753, -761,
-794, -795, -850, -870, -871, -910, -911
O.D. 75.6 mm, Bore 17 mm, W. 20.8 mm,
Single



131842

Replacing 1126 600 536, 9121 146 651
Servicing 9120 144 295, -296, -297, -298
O.D. 56 mm, Bore 17 mm, W. 23.2 mm,
5 grooves



131928

Replacing 1126 600 434
Servicing 0120 469 572, -574, -656, -660,
-747, -748
O.D. 60.9 mm, Bore 17 mm, W. 34.8 mm,
Double

Also see Pulley Survey
page 809

Replacing BOSCH



133742

Replacing 1126 600 749
Servicing 0120 469 016, -017, -909, -910
O.D. 55.2 mm, Bore 17 mm, W. 28.7 mm,
6 grooves



134938

Replacing 1126 600 500
Servicing 0120 469 620, -683,
O.D. 66.8 mm, Bore 17 mm, W. 27.3 mm,
Double



135426

Replacing 1126 600 750
Servicing 0120 485 015
O.D. 69.2 mm, Bore 17 mm, W. 27.5 mm
6 grooves



133870

Replacing 1126 600 997
Servicing 0120 469 870, -871, -970,
0120 488 111, -112, -179, -180, -228
O.D. 59.6 mm, Bore 17 mm, W. 29.6 mm,
6 grooves,



135057

Replacing 1126 600 395
Servicing 0120 489 958, -959,
Case, Ford
O.D. 93.2 mm, Bore 17 mm, W. 19.9 mm,
Single, B-belt type



135441

Replacing 1126 600 822
Servicing 0120 485 025
O.D. 66.1 mm, Bore 17 mm, W. 24.7 mm,
5 grooves



133876

Replacing 1126 600 884
Servicing 0120 469 859, -938, -939
O.D. 64.3 mm, Bore 17 mm, W. 32 mm,
5 grooves



135178

Replacing 1125 600 540
Servicing 0120 469 670, -681, -784, -785,
-787
O.D. 62.6 mm, Bore 17 mm, W. 32.5 mm,
Double



135520

Replacing 1126 600 460
Servicing 0120 488 214, -215,
0120 489 157, -158, -258, -259
O.D. 56.1 mm, Bore 17 mm, W. 23.1 mm,
4 grooves



134684

Replacing 1126 600 117
O.D. 87.7 mm, Bore 17 mm, W. 36 mm,
Double, B-belt type



135356

Replacing 1126 600 850
Servicing 0120 488 144, -145
O.D. 57.7 mm, Bore 17 mm, W. 47.5 mm,
6 grooves



135529

Replacing 1126 600 954
Servicing 0123 212 001
O.D. 55 mm, Bore 17 mm, W. 27 mm,
6 grooves

Replacing BOSCH

Also see Pulley Survey
page 809



135550

Replacing 1126 600 821
Servicing 0120 465 008, -020
O.D. 64.9 mm, Bore 17 mm, 27.4 mm,
6 grooves



135606

Replacing 1126 600 825, -891
Servicing 0120 465 003, -004, -014, -017
O.D. 50 mm, Bore 17 mm, W. 45.7 mm,
8 grooves



136161

Replacing 1126 600 712, -759
Servicing 0120 468 023, -044,
0120 469 860, -861, -875, 0120 488 152
O.D. 65.4 mm, Bore 17 mm, W. 35.3 mm,
4 grooves



135561

Replacing 1126 600 641
Servicing 0120 489 490, -491
O.D. 54.9 mm, Bore 17 mm, W. 15.9 mm,
3 grooves



135776

Replacing 1126 600 976
Servicing 0123 315 003, 0123 335 001
O.D. 56.1 mm, Bore 17 mm, W. 49 mm,
4 grooves



136162

Replacing 1126 600 865, -866
Servicing 0120 468 061, -062, -063, -064,
-070, -071, -072, -073, -074, -089
O.D. 57.1 mm, Bore 17 mm, W. 40.7 mm,
6 grooves



135562

Replacing 1126 601 006
Servicing 0120 335 011, -012
O.D. 62.9 mm, Bore 17 mm, W. 25.1 mm,
6 grooves



135944

Replacing 1126 600 625, -861
O.D. 64.4 mm, Bore 17 mm, W. 32.3 mm,
Single



136471

Replacing 1126 600 906, -975
Servicing 0120 335 008, 0123 115 010,
0123 120 001
O.D. 51.1 mm, Bore 17 mm, W. 27.2 mm,
6 grooves



135584

Replacing 1126 600 952
Servicing 0120 469 011
O.D. 61.2 mm, Bore 17 mm, W. 52.2 mm,
4 grooves



136151

Replacing 1126 600 886, -888
Servicing 0120 469 847, -848, -939, -940
O.D. 59.7 mm, Bore 17 mm, W. 42.4 mm,
5 grooves



136700

Replacing 1126 601 008
Servicing 0120 485 029, -030
O.D. 60.5 mm, Bore 17 mm, W. 27.7 mm,
6 grooves

Also see Pulley Survey
page 809

Replacing BOSCH



136704

Replacing 1126 601 519
Servicing 0123 310 010
O.D. 63.2 mm, Bore 17 mm, W. 25.5 mm,
6 grooves



137248

Replacing 1126 600 927
Servicing 0120 468 102, -103, -104, -105,
-110, -111
O.D. 56.8 mm, Bore 17 mm, W. 32.2 mm,
6 grooves



137252

Replacing 1126 600 000
Servicing 0123 310 028, 0123 320 004,
-020, -022
O.D. 60.3 mm, Bore 15 mm, W. 20.3 mm,
5 grooves



136843

Replacing 1126 601 529
Servicing 0123 100 002
O.D. 67 mm, Bore 17 mm, W. 13.6 mm,
Single



137249

Replacing 1126 600 933
Servicing 0120 465 031
O.D. 49.6 mm, Bore 17 mm, W. 40.5 mm,
6 grooves



137253

Replacing 1126 601 010
Servicing 0120 488 287
O.D. 62.4 mm, Bore 17 mm, W. 24.2 mm,
5 grooves



136859

Replacing 1126 600 994
Servicing 0123 505 007, -009
O.D. 64.5 mm, Bore 17 mm, W. 26.5 mm,
6 grooves



137250

Replacing 1126 600 977
Servicing 0123 315 014
O.D. 69.7 mm, Bore 17 mm, W. 45.8 mm,
Single



137254

Replacing 1126 601 542
Servicing 0123 510 031
O.D. 47.7 mm, Bore 17 mm, W. 27 mm,
6 grooves



137095

Servicing 0123 345 004
O.D. 56.7 mm, Bore 17 mm, W. 29.3 mm,
7 grooves



137251

Replacing 1126 600 980
Servicing 0123 510 018, 0123 540 002,
-004
O.D. 44.1 mm, Bore 17 mm, W. 29.4 mm,
6 grooves



137255

Replacing 1126 601 547
Servicing 0123 310 022
O.D. 55.9 mm, Bore 17 mm, W. 26.8 mm,
5 grooves

Replacing BOSCH

Also see Pulley Survey
page 809



137385

Replacing 1126 600 685
Servicing 0120 488 123, -124, -161, -166, -167, -200
O.D. 49.9 mm, Bore 17 mm, W. 36.2 mm, 5 grooves



137605

Replacing 1126 600 923
Servicing 0120 465 028
O.D. 56 mm, Bore 17 mm, W. 27.9 mm, 7 grooves



137962

Replacing 1126 601 507
Servicing 0123 115 011, 9120 336 000
O.D. 75 mm, Bore 17 mm, W. 16.2 mm, Single



137471

Replacing 1126 600 919
Servicing 0120 485 050
O.D. 64.9 mm, Bore 17 mm, W. 19.2 mm, 3 grooves



137608

Replacing 9122 336 686, -695
Servicing 6033 GB5 007, -009, 9120 335 000, -001, -002
O.D. 93.9 mm, Bore 17 mm, W. 46.8 mm, Double, B-belt type



138063

Replacing 1126 600 367
Servicing 0120 489 123, -124, -947, -948, -950, -951
O.D. 73.4 mm, Bore 17 mm, W. 21 mm, Single



137516

Replacing 1126 601 528
Servicing 0123 310 017, -030, 0123 315 016
O.D. 56.1 mm, Bore 17 mm, W. 32 mm, 6 grooves



137734

Replacing 1126 600 993
Servicing 0123 325 002
O.D. 55.2 mm, Bore 17 mm, W. 23.8 mm, 5 grooves



138064

Replacing 1126 600 770
Servicing 0120 465 006, -012, 0123 213 006, 0123 500 004
O.D. 56 mm, Bore 17 mm, W. 28.9 mm, 6 grooves



137535

Replacing 9122 336 671
Servicing 9120 334 317, -318
O.D. 54.9 mm, Bore 17 mm, W. 22.7 mm, 4 grooves



137818

Replacing 2126 600 030
Servicing 0120 600 562, 0120 689 503
O.D. 106.8 mm, Bore 30 mm, W. 35.1 mm, Double, B-belt type



138065

Replacing 1126 600 987
Servicing 0123 310 003, 0123 315 006, 0123 320 005, 0123 340 005
O.D. 53.6 mm, Bore 17 mm, W. 44.1 mm, 7 grooves

Also see Pulley Survey
page 809

Replacing BOSCH



138066

Replacing 1126 601 011
Servicing 0123 310 006
O.D. 61.9 mm, Bore 17 mm, W. 46.1 mm,
6 grooves



138071

Replacing 1126 601 533
Servicing 0123 310 019, 0123 510 007,
-053, 0123 520 002
O.D. 60.9 mm, Bore 17 mm, W. 44.4 mm,
7 grooves



138281 A

Replacing 1126 601 501
Servicing 0123 115 009, -014
O.D. 64.8 mm, Bore 17 mm, W. 26.3 mm,
5 grooves



138067

Replacing 1126 601 014
Servicing 0123 310 004
O.D. 56.9 mm, Bore 17 mm, W. 22.2 mm,
5 grooves



138072

Replacing 1126 601 562
Servicing 0123 310 041, 0123 320 057,
0123 325 007, 0123 335 004, -005
O.D. 52.1 mm, Bore 17 mm, W. 61.6 mm,
6 grooves



138282 A

Replacing 1126 601 557, F-226556.5
Servicing 0123 320 033, Seat, Skoda, VW
O.D. 56.8 mm, Bore 17 mm, W. 36.2 mm,
5 grooves, w/ Free wheel
Pulley tool: Cargo 210843



138069

Replacing 1126 601 520, F00M 061 001
Servicing 0123 310 011, -013
O.D. 56.5 mm, Bore 17 mm, W. 24.9 mm,
6 grooves



138073 A

Replacing 1126 601 568, F-225644.5
Servicing 0123 320 041, -046, -062,
0123 510 038, -049, -080, Mercedes
O.D. 55.7 mm, Bore 17 mm, W. 37.3 mm,
6 grooves, w/ Free wheel
Pulley tool: Cargo 210843



138339

Replacing 1126 600 522, 6033 605 106,
Servicing 0120 488 146, 0120 300 522,
-545, -546, 0120 339 502, 0120 488 146,
-182, 0120 489 091, -096, -097, -252,
O.D. 62 mm, Bore 17 mm, W. 16.4 mm,
Single



138070

Replacing 1126 600 950, 1126 601 524
Servicing 0120 485 046, 0123 310 001,
-002, -007, -019, -020, 0123 315 001,
-002
O.D. 49.3 mm, Bore 17 mm, W. 36.7 mm,
6 grooves



138203 A

Replacing 1126 601 559, F-226804.5
Servicing 0123 310 035, 0123 320 032,
-059, 0123 510 047, Audi, Skoda, VW
O.D. 56 mm, Bore 17 mm, W. 40.7 mm,
6 grooves, w/ Free wheel
Pulley tool: Cargo 210843



138495

Replacing 1126 601 536, -541
Servicing 0123 310 040, 0123 320 018,
0123 510 026, 0123 515 016,
0123 520 005, -014
O.D. 67.3 mm, Bore 17 mm, W. 37.4 mm,
6 grooves

Replacing BOSCH

Also see Pulley Survey page 809



138600

Replacing 1126 600 910
Servicing 0120 488 249
 O.D. 62.4 mm, Bore 17 mm, W. 30.6 mm,
 4 grooves



139247

Replacing 1126 601 561
Servicing 0123 310 037, 0123 320 034,
 0123 510 065
 O.D. 56 mm, Bore 17 mm, W. 37.2 mm,
 6 grooves



139493

Replacing 1126 601 535
Servicing 0123 310 025, 0123 320 019,
 0123 505 012, -013, 0123 510 027
 O.D. 56 mm, Bore 17 mm, W. 27.3 mm,
 6 grooves



138807 A

Replacing 1126 601 572, F-225643.5
Servicing 0123 320 029, -047,
 0123 510 044, -058, -075, Mercedes
 O.D. 55.5 mm, Bore 17 mm, W. 32.9 mm,
 6 grooves, w/ Free wheel
Pulley tool: Cargo 210843



139248

Replacing 9121 146 630
Servicing 9120 144 604, -605, -606, -610,
 -611, -615, -616, 9120 334 314, -627
 O.D. 94.2 mm, Bore 17 mm, W. 22.5 mm
 Single, C-type belt



139696

Replacing 1126 600 306
Servicing 0120 400 938, -939, -941, -942,
 0120 488 257, -258, 0120 489 069, -070
 O.D. 64.2 mm, Bore 17 mm, W. 46.2 mm,
 Double



138992

Replacing 1126 601 522
Servicing 1123 315 007, -020
 O.D. 60 mm, Bore 17 mm, W. 23 mm,
 4 grooves



139281

Replacing 1126 601 565, F-225355.5
Servicing 0123 310 049, 0123 320 038,
 0123 515 017, -020, Seat, VW, Volvo
 O.D. 49.5 mm, Bore 17 mm, W. 38.7 mm,
 6 grooves, w/ Free wheel
Pulley tool: Cargo 210843



139864

Servicing 0120 400 672, -719, -721,
 -726, -893, -894
 O.D. 92.1 mm, Bore 17 mm, W. 23.4 mm,
 Single



139002

Replacing 1126 601 504
Servicing 0123 214 002, 0123 515 002,
 -025
 O.D. 45.6 mm, Bore 17 mm, W. 30 mm,
 7 grooves



139310

Replacing 1126 600 649
Servicing 0123 510 022, -050, -068
 O.D. 50.2 mm, Bore 17 mm, W. 29.4 mm,
 6 grooves



139932

Replacing F00M 991 004
Servicing 0124 315 003, -004, -008,
 0124 325 003, -011, -016
 O.D. 56.2 mm, Bore 17 mm, W. 36.8 mm,
 6 grooves

Also see Pulley Survey
page 909

Replacing BOSCH



139943

Replacing 1126 601 582
Servicing 0123 100 003, -008
O.D. 54 mm, Bore 17 mm, W. 30.6 mm,
5 grooves



230121

Replacing 1126 601 587, F00M 991 017
Servicing 0123 515 028, 0124 515 020,
-021
O.D. 67 mm, Bore 17 mm, W. 37.5 mm,
6 grooves



230240

Replacing 1126 601 534
Servicing 0123 310 024, -031,
0123 320 017, -025, 0123 515 008
O.D. 55.9 mm, Bore 17 mm, W. 23.5 mm,
5 grooves



139970

Replacing 1126 601 500
Servicing 0123 320 011, -039,
0123 500 002, -017
O.D. 59.6 mm, Bore 17 mm, W. 28.9 mm,
6 grooves



230177

Replacing F00M 991 073
Servicing 0124 325 009, 0124 415 011,
-012
O.D. 60 mm, Bore 17 mm, W. 34.1 mm,
5 grooves



230292 A

Replacing 1126 601 597, F-228824.1
Servicing 0123 320 051, -065,
0123 510 082, -107, -108, Mercedes
O.D. 49.7 mm, Bore 17 mm, W. 38.8 mm,
6 grooves, w/ Free wheel
Pulley tool: Cargo 210843



139971

Replacing 1126 601 515
Servicing 0123 515 008, -015, -017, -018,
-019
O.D. 55 mm, Bore 17 mm, W. 19.4 mm,
4 grooves



230180

Replacing 1126 600 687, 6033 GD5 110
Servicing 0120 450 011, -012, -014, -016,
-017, 0120 469 622, -624
O.D. 67.3 mm, Bore 17 mm, W. 29.8 mm,
4 grooves



230293 A

Replacing F00M 991 002, F-227628.6
Servicing 0124 315 001, -013,
0124 325 001, -025, Audi, Seat, Skoda, VW
O.D. 56.1 mm, Bore 17 mm, W. 41.6 mm,
6 grooves, w/ Free wheel
Pulley tool: Cargo 210843



230083 A

Replacing 1126 601 566, F-225653.5
Servicing 0123 320 055, 0123 515 003
O.D. 56.1 mm, Bore 17 mm, W. 34.3 mm,
5 grooves, w/ Free wheel
Pulley tool: Cargo 210843
Cap: Cargo 138236



230239

Replacing 1126 601 503
Servicing 0123 510 013, -014, -015,
0123 520 003
O.D. 57.6 mm, Bore 17 mm, W. 26.6 mm,
6 grooves



230296

Replacing F00M 991 061, F-230401
Servicing 0124 515 019, -054, Volvo
O.D. 56.7 mm, Bore 17 mm, W. 33.9 mm,
6 grooves, w/ Free wheel, Anti CW-threaded
Pulley tool: Cargo 210843
Cap: Cargo 138236

Replacing BOSCH

Also see Pulley Survey
page 809



230302

Replacing F00M 991 045, F-225653.6
Servicing 0124 325 018, 0124 515 026, VW
O.D. 55.8 mm, Bore 17 mm, W. 33.1 mm,
5 grooves, w/ Free wheel
Pulley tool: Cargo 210843
Cover: Cargo 138236



230306

Replacing 1126 601 593, F-228618.5
Servicing 0123 320 054, 0123 510 091,
VW
O.D. 55.9 mm, Bore 17 mm, W. 34.6 mm,
6 grooves, w/ Free wheel
Pulley tool: Cargo 210843



230312

Replacing F00M 991 044, F-230846.1
Servicing 0123 325 020, 0123 515 024,
Audi, VW
O.D. 56 mm, Bore 17 mm, W. 32.8 mm,
6 grooves, w/ Free wheel
Pulley tool: Cargo 210843



230303

Replacing 1126 601 588, F-226321.5
Servicing 0123 520 004, Audi
O.D. 65 mm, Bore 17 mm, W. 38.1 mm,
6 grooves, w/ Free wheel
Pulley tool: Cargo 210843
Cap: Cargo 230302



230307

Replacing 0122 1AA 7V0, F-229363.6
Servicing 0120 0AA 0C0, Mercedes
O.D. 50 mm, Bore 17 mm, W. 35.1 mm,
6 grooves, w/ Free wheel
Pulley tool: Cargo 210843



230315

Replacing F00M 991 105, F-233525.1
Servicing 0124 515 073, Porsche
O.D. 52.9 mm, Bore 17 mm, W. 33 mm,
6 grooves, w/ Free wheel
Pulley tool: Cargo 210843



230304

Replacing F00M 991 042, F-226322.11
Servicing 0124 515 025, Audi
O.D. 55.8 mm, Bore 17 mm, W. 32.7 mm,
5 grooves, w/ Free wheel
Pulley tool: Cargo 210843



230309

Replacing F00M 991 039, F-230147.2
Servicing 0124 315 006, -012,
0124 325 014, -021, Audi, Seat, VW
O.D. 56 mm, Bore 17 mm, W. 36.9 mm,
5 grooves, w/ Free wheel
Pulley tool: Cargo 210843



230475

Replacing F00M 991 005
Servicing 0124 225 001, -002, -018, -020,
-022, -024, 0124 415 001, -002, -004, -006
O.D. 54.7 mm, Bore 17 mm, W. 27 mm,
5 grooves

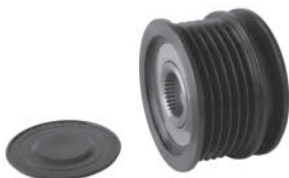

230305

Replacing 6033 GD5 036, F-228215
Servicing 6033 GB3 030, -031, Mercedes
O.D. 55.7 mm, Bore 17 mm, W. 37.3 mm,
6 grooves, w/ Free wheel
Pulley tool: Cargo 210843



230311

Replacing 0122 1AA 6K0, F-230825.3
Servicing Mercedes
O.D. 49.7 mm, Bore 17 mm, W. 38.5 mm,
7 grooves, w/ Free wheel
Pulley tool: Cargo 210843



230503

Replacing 1126 601 023, -024
Servicing 0120 468 128, -134, -326
O.D. 55.1 mm, Bore 17 mm, W. 28.6 mm,
6 grooves

Also see Pulley Survey
page 909

Replacing BOSCH



230519

Replacing F00M 061 016, F-227079.4
Servicing 0123 510 109, Chrysler, Volvo
O.D. 55.8 mm, Bore 17 mm, W. 37.6 mm,
6 grooves, w/ Free wheel
Pulley tool: Cargo 210843



230977

Replacing F00M 991 035
Servicing 0124 225 010, -011, -013, -014
O.D. 48 mm, Bore 17 mm, W. 33.7 mm,
5 grooves



231428

Replacing F00M 991 009
Servicing 0124 415 007
O.D. 54.9 mm, Bore 17 mm, W. 39.1 mm,
6 grooves



230520

Replacing F00M 061 005, F-227820.4
Servicing 0123 520 014, VW, Volvo
O.D. 67.8 mm, Bore 17 mm, W. 39.8 mm,
6 grooves, w/ Free wheel
Pulley tool: Cargo 210843



231092

Replacing 1126 601 102
Servicing 0120 469 115, -117
O.D. 71 mm, Bore 17 mm, W. 36.5 mm,
8 grooves



231441

Replacing F00M 991 029
Servicing 0124 315 005, -007,
0124 325 013, -015, -056, -057,
0124 515 012
O.D. 49 mm, Bore 17 mm, W. 37 mm,
6 grooves



230719

Replacing F00M 991 006
Servicing 0123 310 048, 0124 225 009,
-019, -025, 0124 415 010
O.D. 62.1 mm, Bore 17 mm, W. 13.1 mm,
Single



231110

Replacing 1126 601 518
Servicing 0123 320 012
O.D. 52 mm, Bore 17 mm, W. 46.4 mm,
6 grooves



231584

Servicing 0124 325 013, -024, -031, 0124
415 014
O.D. 54.25 mm, Bore 17 mm, W. 41.6 mm,
6 grooves



230956

Replacing 1126 601 549
Servicing 0123 320 029, 0123 510 044
O.D. 56 mm, Bore 17 mm, W. 29.1 mm,
6 grooves



231258

Replacing F00M 991 053
Servicing 0124 415 006
O.D. 48.1 mm, Bore 17 mm, W. 27.1 mm,
6 grooves



231635

Replacing 1126 600 902
Servicing 0120 469 979
O.D. 65.7 mm, Bore 17 mm, W. 38.2 mm,
5 grooves

Replacing BOSCH

Also see Pulley Survey page 809



231715

Replacing F00M 991 007
Servicing 0124 225 004, -023, -028, -029, -030, -034, 0124 415 005, -008, 0124 515 005, -008, -023, -032, -080, -081
 O.D. 50.1 mm, Bore 17 mm, W. 26.5 mm, 6 grooves



232624

Replacing F00M 991 125
Servicing 0124 325 039, -046, -077, 0124 515 061, -064, -084, -091, -102
 O.D. 50 mm, Bore 17 mm, W. 39 mm, 6 grooves, w/ Free wheel



233510

Replacing 1126 600 763
Servicing 0120 469 874, 0120 488 149, -181
 O.D. 77.4 mm, Bore 17 mm, W. 27 mm, 6 grooves



231973

Replacing F00M 991 074
Servicing 0124 315 014
 O.D. 50.1 mm, Bore 17 mm, W. 27 mm, 5 grooves



233530

Replacing F00M 991 142
Servicing 0124 325 072, -087
 O.D. 49.1 mm, Bore 17 mm, W. 32.9 mm, 6 grooves, w/ Free wheel
Pulley tool: Cargo 210843



232348

Replacing 1126 600 670
Servicing 0120 450 019
 O.D. 66.2 mm, Bore 17 mm, W. 22.8 mm, 4 grooves



233216

Replacing F00M 991 014
Servicing 0124 515 017, -018, 0124 525 001, 0120 625 001
 O.D. 56 mm, Bore 17 mm, W. 28.9 mm, 6 grooves



233597

Replacing F00M 991 056
Servicing 0124 615 002
 O.D. 54.5 mm, Bore 17 mm, W. 28 mm, 6 grooves



232356

Replacing 1126 601 576
Servicing 0123 315 500, -503
 O.D. 69.2 mm, Bore 17 mm, W. 29 mm
 Single



233507

Replacing F00M 991 030
Servicing 0122 468 015, 0122 0AA 1J0
 O.D. 48.6 mm, Bore 17 mm, W. 30.7 mm, 7 grooves



233657

Replacing F00M 991 078, -116, -192
Servicing 0124 315 019, -027
 O.D. 59 mm, Bore 17 mm, W. 68.5 mm, 7 grooves, w/ Free wheel
Pulley tool: Cargo 210948

Also see Pulley Survey
page 909

Replacing BOSCH



233849

Replacing 1126 601 575
Servicing 0123 510 048, -095
O.D. 52 mm, Bore 17 mm, W. 26.6 mm,
6 grooves



233940

Replacing 1126 601 596
Servicing 0123 512 500
O.D. 49.3 mm, Bore 17 mm, W. 35.1 mm,
8 grooves



234026

Replacing F00M 991 055
Servicing 0124 320 001, -002,
0124 325 054, 0124 510 001,
0124 515 044, 0124 555 010
O.D. 67.5 mm, Bore 17 mm, W. 40.7 mm,
6 grooves



233850

Replacing 1126 601 570
Servicing 0123 320 035, -058
O.D. 56 mm, Bore 17 mm, W. 28.1 mm,
6 grooves



233971

Replacing F00M 991 072
Servicing 0124 315 016, -024, -025, -079
O.D. 55 mm, Bore 17 mm, W. 26.5 mm,
6 grooves



234056

Replacing F00M 991 172, F-232369.2
Servicing 0124 615 027
O.D. 54.4 mm, Bore 17 mm, W. 31.6 mm,
6 grooves, w/ Free wheel
Pulley tool: Cargo 210843



233865

Replacing 1126 601 552
Servicing 0123 325 004, -008
O.D. 89 mm, Bore 17 mm, W. 19 mm,
Single



233986

Replacing 1126 601 511
Servicing 0123 115 013
O.D. 54.8 mm, Bore 17 mm, W. 19.9 mm,
4 grooves



234127

Replacing F00M 991 171, F-232369.4
Servicing 0124 525 035
O.D. 54.4 mm, Bore 17 mm, W. 33.5 mm,
6 grooves, w/ Free wheel
Pulley tool: Cargo 210843



233916

Replacing 1126 600 859, -926
Servicing 0120 468 009, -010,
0120 469 786, -793, -992, -993
O.D. 63 mm, Bore 17 mm, W. 34.2 mm,
Double



234016

Servicing 0120 689 ...
O.D. 90.1 mm, Bore 30 mm, W. 38.4 mm,
10 grooves
Key way 8 x 30 mm



234169

Replacing F00M 991 141, F-236528
Servicing 0124 515 098, 0124 525 042,
-045, -048
O.D. 49.1 mm, Bore 17 mm, W. 33 mm,
6 grooves, w/ Free wheel
Pulley tool: Cargo 210843

Replacing BOSCH

Also see Pulley Survey page 809



234354

Replacing F00M 061 013
Servicing 0123 525 502
 O.D. 68.9 mm, Bore 17 mm, W. 48.1 mm,
 12 grooves



234672

Replacing 1126 601 550
Servicing 0123 310 033, -051, -052
 O.D. 80 mm, Bore 17 mm, W. 20.2 mm,
 Single



234796

Replacing F00M 991 181, F-235968.01
Servicing 0124 625 014, -019
 O.D. 49.8 mm, Bore 17 mm, W. 35.2 mm,
 6 grooves, w/ Free wheel
Pulley tool: Cargo 230843



234365

Replacing F00M 991 047
Servicing 0124 415 009, -016, -025, -033
 O.D. 57.1 mm, Bore 17 mm, W. 36.9 mm,
 5 grooves



234675

Replacing F00M 991 095, F-227820.8, -9
Servicing Volvo
 O.D. 69.2 mm, Bore 17 mm, W. 39.9 mm,
 6 grooves, w/ Free wheel
Pulley tool: Cargo 210843

234826

Replacing F00M 991 077
Servicing 0124 515 043, -049,
 0124 525 012, -013, -022
 O.D. 55.9 mm, Bore 17 mm, W. 27 mm,
 6 grooves



234366

Replacing F00M 991 106
Servicing 0124 415 016, -030, -032
 O.D. 53 mm, Bore 17 mm, W. 30 mm,
 6 grooves



234793

Replacing F00M 991 138, F-232001.2, -4
Servicing 0124 515 062, -088,
 0124 615 022, -028
 O.D. 55.5 mm, Bore 17 mm, W. 44.2 mm,
 7 grooves, w/ Free wheel
Pulley tool: Cargo 230843

234968

Replacing F00M 147 743, F00M 991 120
Servicing 0124 555 004
 O.D. 77 mm, Bore 17 mm, W. 49.5 mm,
 11 grooves



234602

Replacing F00M 991 041
Servicing 0124 325 019, 0124 515 028,
 -040, 0124 525 008, -087, 0124 615 007
 O.D. 65 mm, Bore 17 mm, W. 26.5 mm,
 6 grooves



234795

Replacing F00M 991 108, F-231142.1
Servicing 0124 515 059, 0124 525 009,
 -088, 124 615 009
 O.D. 56 mm, Bore 17 mm, W. 35.3 mm,
 6 grooves, w/ Free wheel
Pulley tool: Cargo 230843

235081

Replacing F00M 991 104
Servicing 0124 325 052, 0124 515 113,
 -120, 0124 555 005, -006, 0124 655 006
 O.D. 55 mm, Bore 17 mm, W. 38.5 mm,
 8 grooves

Also see Pulley Survey
page 909

Replacing BOSCH

235331

Replacing F00M 991 090, F010 LD 1120, F-230209, -.2, -.3, 535003210
Servicing 0124 315 020, 0124 325 041, -076, F010 LD 0205, -0206
O.D. 61 mm, Bore 17 mm, W. xx mm, 6 grooves, w/ Free wheel



236762

Replacing F00M 991 128
Servicing 0124 515 031
O.D. 53.85 mm, Bore M17 mm, W. 42 mm, 5 grooves, w/ Free wheel
Pulley tool: Cargo 230843



237817

Replacing F00M 147806
Servicing 0124 425 013, -029
O.D. 55 mm, Bore 17 mm, W. 40.5 mm, 5 grooves, w/ Free wheel
Pulley tool: Cargo 230843



236721

Replacing F00M 991 196
Servicing 0124 525 044, -084, -101
O.D. 49 mm, Bore 17 mm, W. 37.5 mm, 7 grooves



237263

Replacing F00M 991 167, F-235449.2
Servicing 0124 615 026
O.D. 56 mm, Bore 17 mm, W. 34.7 mm, 7 grooves, w/ Free wheel
Pulley tool: Cargo 230843



238734

Replacing F00M 991 216, F-238512.03
Servicing 0124 525 076
O.D. 49 mm, Bore 17 mm, W. 35.9 mm, 7 grooves, w/ Free wheel
Pulley tool: Cargo 230843



236726

Replacing F00M 991 166
Servicing 0124 525 043, 0124 525 049
O.D. 49 mm, Bore 17 mm, W. 31 mm, 6 grooves



237355

Replacing F00M 991 178, F-238120.1
Servicing 0124 525 047
O.D. 49 mm, Bore 17 mm, W. 34.5 mm, 6 grooves, w/ Free wheel
Pulley tool: Cargo 230843



210843

Tool to be used for mounting and dismounting of free wheel pulleys
Shaft L. 74 mm.



210948

As Cargo 210843, but
Shaft L. 114 mm.



236735

Replacing F00M 991 162
Servicing 0124 425 005, -020
O.D. 53.9 mm, Bore 17 mm, W. 37.5 mm, 5 grooves



237600

Replacing 1126 601 567, F-226322.4, -5
Servicing 0123 510 045
O.D. 57.7 mm, Bore 17 mm, W. 34.5 mm, 5 grooves, w/ Free wheel
Pulley tool: Cargo 230843

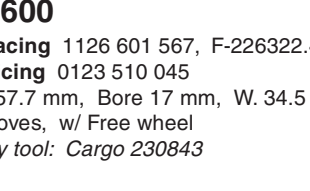

210877

Tool to be used for mounting and dismounting of Bosch rubber clutch pulley
w/ 28 mm. hex socket.

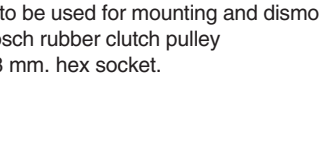

Replacing BOSCH

Fan & Pulley Parts



138092

Replacing 1120 591 505, F-226556-51
Servicing 0123 310 038, 0123 320 033, -036, -041, -046, 0123 325 006, 0123 510 038, -049, -080, -101
 O.D. 49 mm
 Cover for free wheel pulley



138236 Std pkg 5

Replacing 1120 591 506, F-225653-91
Servicing 0123 310 034, -035, -039, 0123 320 031, -032, -037, -038, -047
 O.D. 55.5 mm
 Cover for free wheel pulley



231452

Replacing F-226954-91
 O.D. 34 mm
 Cover for free wheel pulley



138774 Std pkg 5

Replacing 1120 202 008
 17 x 30 x 4.4/5.1 mm
 Spacer



139907 Std pkg 5

Replacing 1120 202 505
Servicing 0123 310 038, 0123 320 033, -036, -041, -046, 0123 325 006, 0123 510 038, -049, -080, -101
 17 x 44 x 5 mm
 Spacer



139931 Std pkg 5

Replacing F00M 990 500
 17 x 39 x 5 mm
 Spacer



234363

Replacing 1120 202 038
Servicing 0120 468 028, -054, -055, -136, -147
 22 x 40 x 6.1/8.1 mm
 Spacer



234463 Std pkg 5

Replacing 1120 140 142
Servicing 0120 468 124, -999, 0120 469 113, 0120 484 018, 0120 488 285, -295, -299
 O.D. 55.25 mm, Bore 17 mm
 Spacer

Vacuum Pumps

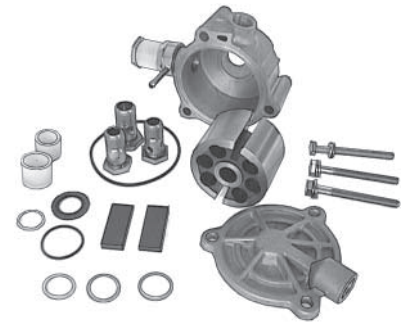

136300

Replacing 9491 147 202
Servicing 9120 144 605, -606, -609, -618, -626, 9120 334 633, 9121 144 019, -021

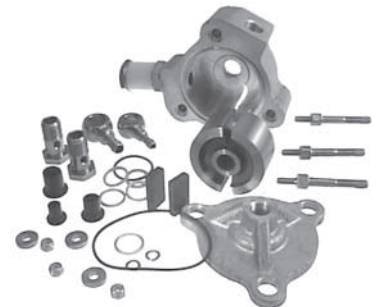

136807

Replacing 9491 147 201
Servicing 0120 488 000, -001, -002, -003, -004, -005



138759

Replacing 9491 335 137
Servicing 9120 335 000, -001, -002

Replacing BOSCH



233262

Replacing 9491 145 100
Servicing 9120 144 605, -606, -610 -611
Rotor: Cargo 137272
Vane kit: Cargo 135973

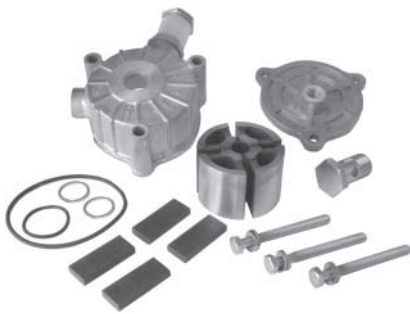

235232

Replacing 9491 335 136
Servicing 9120 334 633, -634, -638, -641

Vacuum Pump Parts



134326

Replacing 9491 146 309
Servicing 0120 488 001, -003, -005, -007, -009, -011
 O.D. 49 mm, W. 25 mm, 18 Splines
 Rotor kit



137272

Replacing 9491 146 305
Servicing 9120 144 601, -603, -604, -611
 O.D. 49 mm, W. 25 mm, 18 Splines
 Rotor
Vane set: Cargo 135973 (2 pcs.)
Vane set: Cargo 133277 (4 pcs.)



230251

Replacing 9491 146 310
Servicing 9120 144 608, 9120 334 635, 9120 335 000, -001
 O.D. 52.7 mm, W. 35 mm, 18 Splines
 Rotor
Vane set: Cargo 137153



233793

Replacing 9491 145 501
Servicing 9120 144 605, -606, -610 -611, Cargo 233262
 Cover for vacuum pump



080240 Std pkg 10 A

Replacing 9491 143 304
Servicing 0120 488 001, -003, -005, -007, -009, -011
 Hose nipple for M12 hollow screw
 For hose I.D. 7 mm



080242 Std pkg 10 A

Replacing 9491 143 302
Servicing 0120 488 001, -003, -005, -007, -009, -011
 Hose nipple for M14 hollow screw
 For hose I.D. 9 mm



135973

Replacing 9491 142 300, 9491 147 007
 5 x 13.8 x 25 mm
 Rotor vane set



137153

Replacing 9491 147 011
Servicing 9120 334 625, -626
 5 x 14.75 x 34.9 mm
 Rotor vane set

Replacing BOSCH



133277 A
5 x 13.8 x 25 mm
Rotor vane set



231608
Servicing 0120 488 000, -001, -008, -009, -012
M18-1.5
Valve

Repair Kits



134541 A
Replacing 1127 011 054
Servicing 0120 450 003, -004, 0120 469 501, -503, -504, -505, -511, -515
Terminal kit
B+ insulator only: Cargo 131823



134544
Replacing 1127 011 142
Servicing 0120 468 008, -014, 0120 469 776
Terminal kit



134542
Replacing 1127 011 079
Servicing 0120 469 531, -566, -574, -618, -619, -656, -657, -658, -660, -662, -677, -748, -754, -758, -759, -778, -779, -783, -805, -806
Terminal kit



134545
Replacing 1127 011 155
Servicing 0120 469 876, -877, 0120 469 868, -869, -901, -902
Terminal kit



134543
Replacing 1127 011 092
Servicing 0120 489 311, -312, -361, -363, -365, -366, -368, -370, -371, -373, -375, -377, -379, -380, -381, -383, -425, -428, -430, -431
Terminal kit



134547
Replacing 1127 011 165
Servicing 0120 469 042, -043
Terminal kit

Replacing BOSCH

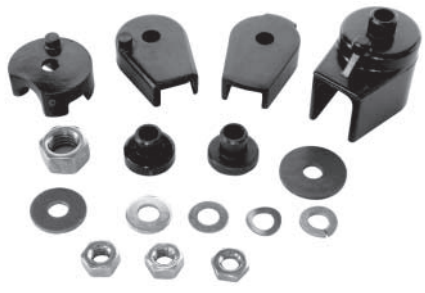

135449
Replacing 1127 011 047
Servicing 9120 143 201, -202, -223, -225, -228, 9120 144 102, -103, -104, -105, -109, -110, -236, -237, -238, -239, -241, -243, -266
 Terminal kit



136699
Replacing 1127 011 071
Servicing 0120 468 037, -053, -065, -066, -093, -094, -107, -113, -114, -115, -116, -118, -124, -129, -130, 0120 469 001, -008
 Terminal kit



139249
Replacing 1127 011 088
Servicing 0120 488 001, -003, -005, -007, -009, -011, -012, 0120 489 394
 B+, D+ Terminal kit



136012
Replacing 1127 011 083
Servicing 0120 689 511, -513, -515, -516, -517, -518, -520, -522, -523, -526, -527
 B+, B- and D+ insulator. Terminal kit
OE kit: Cargo 231814



137509
Replacing 1127 011 050
Servicing 9120 144 016, -026, -203, -204, -205, -206, -216, -217, -221, -231, -284, -286, -294, -296, -303, -310, -311, -318
 Terminal kit



139250
Replacing 1127 011 093
Servicing 0120 450 012, -014, -016, -017, -020, -022, -023, -024, -025, -026, -027
 B+ Terminal kit



136046
Replacing 1127 011 161
Servicing 0120 468 061, -062, -063, -064, -075, -076, -077, -078, -102, -103, -104, -105, -111, 0120 469 006, -007, -906, -907
 Terminal kit



139007
Replacing 1127 011 062
Servicing 0120 488 177, -182, -210, 0120 489 047, -048, -075, -088, -091, -093
 B+, D+, W Terminal kit



139282
Replacing 1127 011 146
Servicing 0120 469 993, -994, -995, -997, 0120 484 001, -002, -003, -011, -012, -015
 B+, D+ Terminal kit

Replacing BOSCH



230245

Replacing 9491 147 016
Servicing 6033 GB4 008, -015, 9120 144 621, -622, -623, -624, -625, -626, -627, -628, -635, -636, -638, -641
 Terminal kit



231703

Replacing 1127 011 151
Servicing 0120 468 028, -054, -055, -136, -147
 Terminal kit



135553

Replacing 1127 011 052
Servicing 0120 400 863, -836, -837, 0120 489 565, -566, -584



231090

Replacing 1127 011 144
Servicing 0120 468 143, -145, 0120 469 101, -102, -107, -108, -109, -110, -111, -112, -113, -114, -115, -117, 0120 488 252, -253, -256, -266, -277, -278
 Terminal kit



231814

Replacing 1127 011 083
Servicing 0120 689 511, -513, -515, -516, -517, -518, -520, -522, -523, -526, -527, -528, -530, -531, -533, -534, -535, -538
 Terminal kit
Terminal W only: Cargo 233089



136010

Replacing 1127 011 064
Servicing 0120 689 503, -504, -505, -506, -507, -508, -511, -512, -513, -514, -515, -516, -517, -518, -524, -525, -532, -538, -539, -550



231126

Replacing 1127 011 070
Servicing 0120 468 009, -010, -011, -012, -015, -016, -019, -020, -025, -026, -027, -035, -036, -045, -046, -052, -059, -070
 B+, D+
 Terminal kit



233855

Replacing 1127 011 061
Servicing 0120 488 125, -132, -133, -135, -136, -137, -153, -208, -224, -232, -268, -269, -270, -271, -273, -289, 0120 489 022, -023, -027, -032, -033, -034
 Terminal kit



136011

Replacing 1127 011 171
Servicing 0120 689 520, -523, -526, -528, -530, -531, -533, -534, -535, -543, -545, -546, -548, -549

Replacing BOSCH



137089

Replacing 1127 011 019
Servicing 0120 469 008, -019, -024, -506, -509, -518, -526, -562, -585, -692, -761, -891, -983, 0120 488 208, -232, -271, -289



138094

Replacing 1127 011 160
Servicing 0120 468 107, -113, -115, -116, -118, -121, -124, -127, -128, -129, -130, -131, -132, -134, -137, -143, -145, -149

Sundry Parts



131823 Std pkg 5 **A**
Servicing Audi, VW 75/90 Amp. alternators
 B+ insulator



137148

Replacing 1127 011 020
Servicing 0120 400 635, -644, -648, -652, -665, -680, -693, -707, -708, -709, -714, -717, -723, -725, -743, -747, -755, -761



138166

Replacing 1127 011 022
Servicing 0120 400 752, -753, -767, -768, -794, -795



132081 Std pkg 5 **A**
Servicing BMW 45/65 Amp. alternators
 B+ insulator



137149

Replacing 1127 011 090
Servicing 0120 468 002, -003, -031, -033, 0120 488 139, -141



231091

Replacing 1127 011 143
Servicing 0120 469 001, -013, -101, -686, -687, -895, -982, 0120 488 256, -277, -278, -282, -291, 0120 489 315, -316, 6033 GB3 008



132768 Std pkg 5
 B+ insulator



136302 Std pkg 5
 Part of 1127 011 047 - Cargo 135449
 B+ insulator

Replacing BOSCH



139004

Replacing 1120 591 111
Servicing 0123 214 002, 0123 515 002, -010
 B+ insulator



233099

Servicing 0120 400 949, -950, -951, -952, -953
 I.D. 6 mm
 B+ insulator



138928

Replacing 9121 330 507
Servicing 9120 334 317, -318
 D+ insulator



230590 Std pkg 5

Servicing 0120 450 011, -012, -014, -016, -017
 B+ insulator
Part of 1127 011 093, Cargo 139250



233919

Replacing F00M 05A 400
Servicing 0123 520 017
 Terminal 6.3 mm
 B+ insulator



131824 Std pkg 5 A

Servicing BMW 80/90 Amp. alternators
 B+ and D+ insulator



230728

Replacing 1120 591 074
Servicing 0120 488 109, -110, -111, -112, -146, -147, -148, -149, -150, -178, -179, -180, -181, -243, 0120 489 460, -461, -477, -478
 B+ insulator



136474 Std pkg 10

Replacing 1121 090 307
Servicing 0123 310 029
 D+ insulator



131825 Std pkg 5 A

Servicing BMW 80/90 Amp. alternators
 B+ and D+ insulator



231271

Replacing F00M 147 200, -201, -202
Servicing 0124 325 006, -007
 B+ insulator



136718 Std pkg 5

Replacing 1120 390 001
Servicing 0120 489 565, -566, -583, -584
 D+ insulator



132767 Std pkg 5 A

B+ and D+ insulator

Replacing BOSCH



132806 Std pkg 5 **A**
B+ and D+ insulator



137245
Replacing 1120 591 109
Servicing 0120 465 031, 0120 485 048
B+ and D+ insulator



233563 Std pkg 10
Replacing F00M 146 634
Servicing 0124 315 015, -016, -024, 0124 325 023, -030, -062, -071, -072, -079, -085, -086, -087, 0124 415 006, 0124 515 050, -051, -097, -098, -105
B+ cap



132807 Std pkg 5 **A**
B+ and D+ insulator



138432
Replacing 1120 591 118
Servicing 0123 310 006, 0123 320 012
B+ and D+ insulator



138761 Std pkg 10
Servicing 0120 469 757, -759
5 x 7.5/13 x 7 mm
Insulator



135509 Std pkg 5
B+ and D+ insulator



230754 Std pkg 10
Servicing 0120 469 829, -830, -878, -879, -913, -914, -918, -919, 0120 488 183, -184, -219, -220
B+ and D+ insulator



230755 Std pkg 10
Servicing 0120 469 829, -830, -878, -879, -913, -914, -918, -919, 0120 488 183, -184, -219, -220
Insulator



134979 Std pkg 5
Part of 1127 011 092, -102, Cargo 134543
B+ and D+ insulator



139927
Replacing F00M 146 624
Servicing 0124 320 001, 0124 515 017, -019, -020, -021, -054
B+ cap



231536 Std pkg 10
Servicing 0120 489 ...
5.6 x 7.5/14.3 x 3.9 mm
Insulator

Replacing BOSCH



233770

Servicing 0120 400 600, -601, -602, -603, -604, -605, -607, -611, -637, -675, -708, -736, -756, -757, -835
6 x 14 x 1.5 mm
Insulator



136018

Replacing 1127 402 000
Servicing 0120 623 052, 0120 689 502, -503, -504, -505, -506, -507, -508, -511
Oiler



231170

Replacing 1123 527 036
Servicing 0120 468 143, -145, 0120 469 101, -102, -103, -113, -115, -116, 0120 488 252, -253, -288
M6 x 30 mm
Stud

235317

Servicing 0120 488 153
I.D. 4 mm, O.D. 13.9 mm, L. 13 mm,
Insulator



136019 Std pkg 5

Replacing 1127 402 001
Servicing 0120 623 052, 0120 689 503, -504, -505, -506, -507, -508, -511, -512
Oiler

136013

Replacing 1120 200 015
Servicing 0120 689 ...
15 x 20 x 11.2 mm
Distance ring

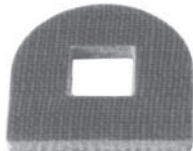

238989

Servicing 0120 339 512, -543, -544, -545
Insulator



136009 Std pkg 4

Replacing 2912 212 207
Servicing 0120 689 ...
DIN 835 - M6 x 35 mm - 5.6
Stud

135314 Std pkg 10

17 x 25 / 30 x 8.1 mm
Steel washer



134551

Replacing 1120 099 022
Servicing 0120 488 149, -148, 0120 489 477, -478
Terminal block



230611 Std pkg 5

Replacing 1123 502 000
M5 x 32 mm
Stud

233999 Std pkg 5

Replacing 1120 101 000
Servicing 0120 400 630, -631, -752, -753, -794, -795, -889, -890, 0120 469 539, -561, -593, -617, -618, -619, -782, -783
15.3 x 25 x 1.5 mm
Washer



Also see O-ring Survey
page 854

Replacing BOSCH



234353 Std pkg 5
Replacing 1120 591 513
Servicing 0123 325 500, -501
 17 x 55 x 3.5 mm
 Washer



234669 **Servicing** 0122 468 015, 0122 0AA 0B0,
 -0R0, -1A0, -1J0, -1P0
 XX x 2.15/5.00 mm
 Gasket



234886 **Replacing** 9491 337026
Servicing 6033GB 4016, -5007, -5009,
 -5010, -5011, 9120 334 631, -632,
 9120 335 000, -001, -002
 Terminal Kit



135060 Std pkg 10 **A**
 11.3 x 18.4 x 3.5 mm
 Felt



134554
Replacing 1120 591 091
Servicing 0120 468 . . . , 0123 510 013,
 Cover



134557 Std pkg 10 **A**
Replacing 1124 682 000
 Terminal lock



232432 Std pkg 10
 53 x 2 mm
 O-ring



134555 Std pkg 10 **A**
Replacing 1121 030 000
 Wire clip



134558 Std pkg 10 **A**
Replacing 1124 682 002
 Terminal lock

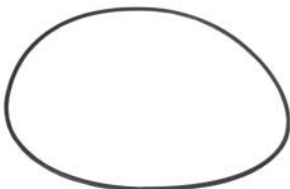

232433 Std pkg 5
 160 x 2.5 mm
 O-ring



234032 Std pkg 5
Replacing 1121 331 508
Servicing 0123 325 013
 Wire clip



132804 **A**
 Terminal plug
 3 pin

Replacing BOSCH



190259 Std pkg 10 **A**
Replacing 1194 485 402
 Terminal plug
 3 pin
Terminal: Cargo 190252



190762 Std pkg 10 **A**
Replacing 1194 485 404
 Terminal plug
 4 pin
Terminal: Cargo 190252



190764
 Terminal plugs
 3 pin
 W/ wire 750 mm



190765
 Terminal plugs
 4 pin
 W/ wire 750 mm



234347
Replacing 9121 334 418
Servicing 9120 334 638, -641
 10.7 x 13.14 x 12.65 mm
 Plug w/ wire



137247 Std pkg 4
Replacing 1123 450 025
Servicing 0120 468 029, -101, -125
 M6 x 137 mm
 Thru bolt



137819 Std pkg 4
Replacing 1123 410 038
Servicing 0120 689 ...
 M6 x 117 mm
 Thru bolt



138592 Std pkg 10
Replacing 1123 429 200
 M5 x 107 mm
 Thru bolt



139435 Std pkg 4
Replacing 1123 429 125
 M6 x 105 mm
 Thru bolt



191292 Std pkg 100 **A**
Replacing 1123 429 102
 M5 x 110 mm, 40 mm thread
 Thru bolt



191582 Std pkg 100
Replacing 1123 429 133
 M5 x 100 mm
 Thru bolt



191584 Std pkg 100
Replacing 1123 429 207
 M5 x 125 mm
 Thru bolt

Replacing BOSCH



191585 Std pkg 100
Replacing 1123 429 203
 M5 x 135 mm
 Thru bolt



136834 Std pkg 3
Replacing 1123 433 030
Servicing 0123 505 ...
 M5 x 49.7 mm
 Combi screw



230732 Std pkg 3
Replacing F00M 990 702
Servicing 0124 215 001, -002, -003, -004, -005, -006, 0124 220 002, 0124 225 001, -002, -004, -009, -010, -011, -012, -013
 M5 x 22 mm
 Screw



230706 Std pkg 4
Replacing 1123 429 007
 M5 x 47 mm
 Thru bolt



137216 Std pkg 3
Replacing 1123 433 017
Servicing 0123 310 ...
 M5 x 31 mm
 Screw for rectifiers



230777 Std pkg 10
Replacing F00M 990 701
Servicing 0124 215 001, -002, -003, -004, -005, -006, 0124 220 002, 0124 225 001, -002, -004, -009, -010, -012, -013, -014
 M4 x 10 mm
 Screw



230731 Std pkg 4
Replacing F00M 990 102
Servicing 0124 215 001, -002, -003, -004, -005, -006, 0124 220 002, 0124 225 001, -002, -004, -009, -012, -013, -014, -015
 M5 x 60 mm
 Thru bolt



230601 Std pkg 10
Replacing 1123 435 002
 M3.1 x 17.4 mm
 Screw for cover



231561 Std pkg 10
Replacing 1123 433 004
 M4 x 18 mm
 Screw



231252 Std pkg 4
Replacing 1123 429 204
Servicing 0120 400 712, -713, -733, -745, -747, -764, -765, -774, -788, -789, -790, -791, -800, -830, -874, -881, -882, -891
 M5 x 115 mm
 Thru bolt



230699 Std pkg 5
Replacing 1123 433 031
Servicing 0120 465 031, 0120 485 029, -030, -048, 0123 214 002, 0123 215 001, 0123 310 006, -014, 0123 315 004, -013
 M5 x 43 mm
 Screw



137246 Std pkg 5
Replacing 1121 331 003
Servicing 0120 469 029, -101, -125
 Lock washer

Replacing BOSCH



231279

Replacing 1120 312 000

Servicing 0120 469 641, -667,
0120 689 503, -505, -506, -507, -508,
-511, -513, -515, -516, -517, -518, -520

Rubber grommet

Fits on cover: Cargo 137828

233821

Servicing 0123 510 108

Connector arm D+

Replacing BOSCH

Generator Armatures



130071

Replacing 1104 012 042, -949
Servicing 0101 209 031, -032, -033, -036, -037, -041, -046, -060, -064, -065, -069
 12 V. 11 Amp.
 L. 206 mm, O.D. 55.9 mm



130073

Replacing 1104 013 956
Servicing 0101 302 067, -068, -075, -076, -085, -086
 12 V. 30 Amp.
 L. 260.5 mm, O.D. 64.9 mm



130309

Replacing 1104 013 943
Servicing 0101 302 021, -022, -023, -026, -027, -029
 12 V. 30 Amp.
 L. 233.1 mm, O.D. 65.2 mm



138258

Replacing 1104 013 436, -952
Servicing 0101 302 107, -108, 0101 304 005, -006
 12 V. 38 Amp.
 L. 274.3 mm, O.D. 64.8 mm



233502

Replacing 1104 012 914
Servicing 0101 206 064, -116, -117
 12 V. 38 Amp.
 L. 246.6 mm, O.D. 56 mm

Generator Field Coils



130076

Replacing 1104 103 007, -008
Servicing 0101 302 111
 12 V. 30 Amp.



130310

Replacing 1104 102 040, -041
Servicing 0101 209 031, -032, -036, -037,
 12 V. 11 Amp.



136028

Replacing 1104 103 020/021, -024/025
Servicing 0101 302 023, -026, -027, -096
 12 V. 30 Amp.



139171

Replacing 1104 103 043, -044
Servicing 0101 302 120
 12 V. 20 Amp.

Replacing BOSCH

Generator Brackets C.E.



135821

Replacing 1105 853 318
 Servicing 0101 302 085, -086, -111, -112, -115, -116, -117, 0101 304 005

Generator Brackets S.R.E.



135185

Replacing 1125 883 046
 Servicing 0120 489 565, -566, -583, -584

Generator Regulators



130002

Replacing 0190 350 049, -068
 12 V. 30 Amp. 300 Watt



130008

Replacing 0190 350 063
 12 V. 38 Amp. 220 Watt



130032

Replacing 0190 309 019
 12 V. 30 Amp. 240 Watt



130037

Replacing 0190 118 005
 24 V. 19 Amp. 300 Watt



130046

Replacing 0190 213 032
 6 V. 45 Amp. 180 Watt



130047

Replacing 0190 215 028
 12 V. 11 Amp. 90 Watt

Replacing BOSCH

Generator Brush Sets



BX131 2 Std pkg 10
Replacing 1107 014 109
 6 x 14 x 19 mm
 6 V.



BX140 2 Std pkg 10
Replacing 2107 014 007
 6 x 22 x 25.5 mm
 24 V.



BX157 2 Std pkg 10
Replacing 1107 014 138
 6 x 14 x 20 mm
 12 V.



BX164 2 Std pkg 10
Replacing 2107 014 017
 6 x 22 x 25 mm
 6 V.



BX165 2 Std pkg 10
Replacing 1107 014 128, -140, -146
 6 x 22 x 25 mm
 12 V.



BX169 2 Std pkg 10
Replacing 1107 014 144
 6 x 14 x 19 mm
 12 V.



BX192 2 Std pkg 10
Replacing 2107 014 012
 8 x 28 x 33.5 mm
 12/24 V.

Dynastarter Brush Sets



NOX29 2P Std pkg 10
Replacing 1027 014 106
Servicing NSU Dynastarter
 5.8 x 10 x 22 mm
 12 V.

Replacing BOSCH

Generator Bushings



140005 Std pkg 10
Replacing 1100 301 003
 15.10 x 22.04 x 12.70 mm



140141 Std pkg 10
Replacing 1100 301 001
 15.11 x 18.09 x 12.80 mm

Generator Repair Kits



133632
Replacing 1107 011 515
Servicing 0101 206 . . .
 Terminal kit

Replacing BRIGGS & STRATTON

Regulators/ Rectifiers

Volt setting 14.4 V.



230149

Replacing 393374, 394890
Servicing 8-20 HP Eng.
 W/ 10-16 Amp. charging systems
 12 V.
 Regulator/rectifier

Volt setting 14.4 V.



234167

Replacing 493219
Servicing 16 Amp. dual output charging
 systems 8 HP to 20 HP engines.
 12 V.
 Accommodates no-charge lamp.
 Regulator/rectifier

Volt setting 14.4 V.



234170

Replacing 491546, 691188
 12 V.
 9 Amp. charging system
 Regulator/rectifier

Volt setting 14.4 V.



234171

Replacing 397809, 691185
Servicing 8 Amp. quad-circuit charging
 systems
 12 V.
 Ceramic hybrid construction
 Regulator/rectifier

Rectifier Parts



234190

Replacing 392606, 691955
Servicing 5 Amp. Tri-circuit systems
 2-6 Amp. diodes
 Rectifier lead



234191

Replacing 393814
Servicing Single circuit systems
 1-6 Amp. diodes
 Rectifier lead



234192

Replacing 393456
Servicing Dual-circuit systems
 (except model 32)
 1-6 Amp. diodes
 Rectifier lead

Replacing BUTEC

Stators



133981

Replacing 851270, 853722
Servicing A24AB, A24AB/20, -30, -35, 853435, 853446, 853486, 852584
 24 V. 60 Amp.
 O.D. 168.6 mm, I.D. 121.4 mm, W. 51.3 mm

Regulators

Adjustable voltage



131278

Replacing 850480, 851195
Servicing A3, A13
 24 V.
 Screw connections



135755

Replacing 857238
Servicing A24R/10, -11, -12, -13, -15, -16, -17, -24
 24 V.

237695

Servicing 859605, 860052
 24 V. 55 Amp.
 O.D. 127 mm, I.D. 89.5 mm, W. 30.5 mm



132970

Replacing 854485
Servicing A3024/13
 24 V.

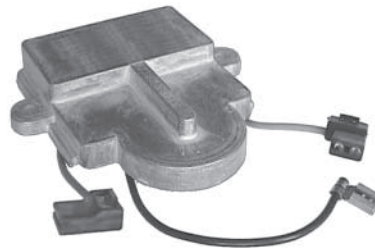

234272

Replacing 859329
Servicing LNA 4024-1, -2, -3, -4, -5, -6, -7, -8, -9, LNA 5524-2
 24 V.



133518

Replacing 857568
Servicing A3024/20, -29, -30, -33, -41, -43, A3524/10, A4024/10, -15, -24, -25, A5524/30, -39, -40, -42, -44, -46, -49, -50, -56, -58
 24 V.

Replacing BUTEC

Rectifiers

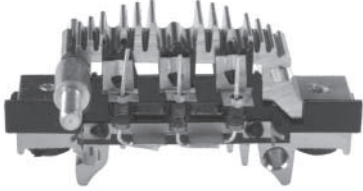

135857

Replacing 855806
Servicing A3024

Slip Rings



133396 Std pkg 5

Replacing 854304
Servicing A30, A35, A40
O.D. 25.0 mm, Shaft 10.0 mm, L. 22.5 mm

Brush Boxes



136404

Replacing 853369
Servicing A13, A24

Replacing BUTEC

Brush Sets



BUTX2 2 Std pkg 10
Replacing 850009, 851998
Servicing A7, A13, A24
 16 x 7.6 mm
 24 V.



141029
Replacing 854312
Servicing A3024..., A3524..., A4024..., A5524...
 4.56 x 6.35 x 20.0 mm
 24 V.

Sundry Parts



136405 Std pkg 5
Replacing 850066, 853003
Servicing A13, A24
 M8 x 44
 Screw terminal
 Positive



136406 Std pkg 5
Replacing 853004
Servicing A13, A24
 M6 x 44
 Screw terminal
 Negative



136410
Replacing 850092
Servicing A7/21B, A13, A24
 Insulator block



136407 Std pkg 5
Replacing 850068
Servicing A13, A24
 6.6 x 9.3-20.55 x 5.5 mm
 Insulator



136408 Std pkg 5
Replacing 850069
Servicing A13, A24
 5.1 x 7.8-15.8 x 9.4 mm
 Insulator



136413 Std pkg 2
Replacing 850071
Servicing A7/21B, A13, A24
 8.3 x 11.0-20.6 x 5.5 mm
 Insulator



136409 Std pkg 3
Replacing 850077
Servicing A7/21 B, A13, A24
 Connector for terminal plate

Replacing CAV

Rotors



137034

Replacing 6220-321A
Servicing AC512, AC5A12
 12 V. 30 Amp. 4 pole
 L. 182 mm, O.D. 95 mm, Shaft 19/20 mm

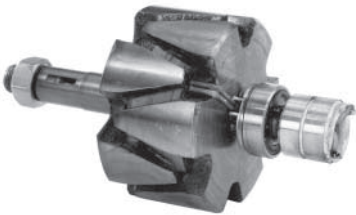

137035

Replacing 6332-321E
Servicing AC512, AC5A12
 12 V. 60 Amp. 6 pole
 L. 180 mm, O.D. 95 mm, Shaft 19 mm



137036

Replacing 6220-321,B
Servicing AC524, AC5A24
 24 V. 30 Amp. 4 pole
 L. 181 mm, O.D. 90 mm, Shaft 19/20 mm



139368

Replacing 6332-A1300, -A1388
Servicing AC203R-115-24-11, -12, -17, -19, -21, -22, -23, -25
 24 V. 115/180 Amp.
 L. 293 mm, O.D. 146 mm, Shaft 30 mm



139663

Replacing 6332-A1433
Servicing AC203-060-24-1, -2, -3, -4, -8, -10, -11, AC203-080-24-1, -4, -5, -10
 24 V. 60/80 Amp.
 L. 369 mm, O.D. 143.5 mm, Shaft 30 mm



139692

Replacing 6332-A1352
Servicing AC172R..., 1276500, 1277011, -021, -031, -040, -050, -300, -320, -340, -350, -370, -380, -390
 24 V. 65/100 Amp.
 L. 243 mm, O.D. 126 mm, Shaft 30 mm



139739

Replacing 6220-321J, 6332-A1416
Servicing AC524m AC5RS24..., 1268410, -420, -430, -450, -470, -480, -510, -520, -550, -560, -570, -580, -590
 24 V. 55 Amp.
 L. 183 mm, O.D. 95 mm, Shaft 19 mm

Replacing CAV

Rotor Parts



139742

Replacing 5330-423
 Servicing AC5..RS..
 5/8" - 18 Self-locking
 Rotor shaft nut



234137

Replacing 5330-501
 Servicing AC172R, AC203R, AC203RA
 M24-1.5
 Rotor shaft nut



230962

Replacing NK1-9
 Servicing AC203, AC203R, AC202RA
 4.8 x 18.5 x 7.8 mm
 Key



234076

Replacing NK1-8
 Servicing 1268690
 4 x 7.5 x 19 mm
 Key

Stators



139369

Replacing 6332-A1387
 Servicing AC203R-115-24-12, -25
 24 V. 115 Amp.
 W/ bracket



139388

Replacing 6270-A1117, 6270-48
 Servicing AC203-060-24-1, -3, -10,
 AC203-080-24-1, -5, -10, 1284001, -003,
 -009, -101, -105, -110
 24 V. 60/80 Amp.
 W/ bracket



139683

Replacing 6332-A1469
 Servicing AC203RA, 1286000
 24 V. 115 Amp.
 W/ bracket



139684

Replacing 6332-A1470
 Servicing AC203RA..., 1286500
 24 V. 180 Amp.
 W/ bracket



139687

Replacing 6332-A1379
 Servicing AC203R..., 1285513, -521,
 -525, -527, -529, -531
 24 V. 115 Amp.
 W/ bracket



139688

Replacing 6332-A1391
 Servicing AC203R..., 1285600
 24 V. 180 Amp.
 W/ bracket

Replacing CAV



134733

Replacing 6220-123, A
Servicing AC524
 24 V. 30 Amp. 4 pole
 O.D. 135.2 mm, I.D. 94.2 mm, W. 21.8 mm



139693

Replacing 6332-A1350
Servicing AC172R, 1277011
 24 V. 65 Amp.
 O.D. 172.1 mm, I.D. 126.6 mm, W. 37.2 mm

Brackets D.E.



139740

Replacing 6220-898A
Servicing AC5RS..., 1268040, -520, -550, -560, -580, -590, -610, -690
Bearing: Cargo 140175



134734

Replacing 6220-124
Servicing AC512
 12 V. 30 Amp. 4 pole
 O.D. 135.2 mm, I.D. 94.2 mm, W. 21.7 mm



139738

Replacing 6332-A1419
Servicing AC5RS-24, 1268580, -590, -610, -690
 24 V. 55 Amp.
 O.D. 135.4 mm, I.D. 95.1 mm, W. 21.8 mm



134735

Replacing 6332-A1263, -A1274
Servicing AC524, -5R24
 24 V. 60 Amp. 6 pole
 O.D. 135.1 mm, I.D. 94.5 mm, W. 22.5 mm



230905

Replacing 6332-A1235
Servicing AC5..., AC5RS.. : 1260B020, -030, -190, -200, -220, -296, 1266010, -020, 1268010, -030, -040, -050, -090
 12 V. 60 Amp. 6 pole
 O.D. 131 mm, I.D. 96 mm, W. 22 mm

Also see O-ring Survey
and Oil Seal Survey

Replacing CAV

Brackets S.R.E.



139734

Replacing 6220-905
Servicing AC5RS...
Insulating band: Cargo 139735

Bracket Parts



139735

Replacing 6220-143
Servicing AC5R...
Insulating band for S.R.E. Bracket



139382

Replacing 6270-54A
Servicing AC203
22.63 x 47.5 x 10 mm
Oil seal



139378

Replacing 6270-40
Servicing AC203
Plate clamp



139383

Replacing 6270-54B
Servicing AC203
29.5 x 40.5 x 7 mm
Oil seal



080823

Replacing 5393-252A, -B
Servicing AC5RS, 1268700
23.1 x 35.1 x 7 mm
Oil seal



139624

Replacing 6270-54E
Servicing AC203R
40 x 52.5 x 6.5 mm
Oil seal



139381

Replacing 6270-54
Servicing AC203
23.63 x 37.5 x 7 mm
Oil seal



139737 Std pkg 5

Replacing 6220-481
Servicing AC5RS
34 x 1.7 mm
O-ring

Replacing CAV

Covers



138890

Replacing 6220-592
Servicing AC5R...



139686

Replacing 6010-234
Servicing AC203RA...



231220

Replacing 6220-422
Servicing AC5...

Regulators



130604

Replacing 1697D220
Servicing AC5
12 V.
Terminals ÷ A WL F HI MED LO



130605

Replacing 1697D520
Servicing AC5, AC7
24 V.
Terminals ÷ A WL F HI MED LO



131140

Replacing 1697C533
Servicing AC203
24 V. 80 Amp.
Terminals M1 M2 A F HI MED LO



131182

Replacing 6317-31A, C, D, G, H, O
Servicing AC5R, - 7, 1266420, 1266430,
1266440, 1266460, 1266470, 1266480
24 V.
Terminals Black D÷, Green DF,
Yellow D+, Red B+



131223

Replacing 6317-31F
Servicing AC5HER, 1267020, 1267030,
1267040
12 V.
Terminals Black D÷, Green DF,
Yellow D+, Red B+

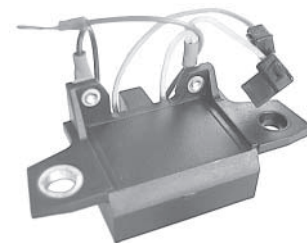

135046

Replacing 1861540, 546-10
Servicing AC5RS-24, 1268410, 1268420,
1268430, 1268450, 1368470, 1268690
24 V.
Terminals Black D÷, Green DF,
Yellow D+, Red B+

Replacing CAV



135602

Replacing 1861542, 1861A542
Servicing AC5RS24, 1268460M, -490M, -500M, -530M, -540M, -600M, -630M
 24 V.
 Terminals Black D±, Green DF, Yellow D+, Red B+



138498

Replacing 1861524, 1861A524
Servicing AC172R, 1277011, -021, -040, -050, -300, -320, -370, -380, -390, -410
 24 V.
 Terminals Black D±, Green DF, Yellow D+, Red B+



230074

Replacing 1861700, -706, 594-1, -4
Servicing AC203R-115-24-26, -29
 24 V.
 Terminals Black D±, Green DF, Yellow D+, Red B+



135603

Replacing 1861546, 1861A546
Servicing AC5RS-12, 1268020M, -070M, -100M
 12 V.
 Terminals Black D±, Green DF, Yellow D+, Red B+

Volt setting 14.75 V.



139363

Replacing 1697D546, 1861666
Servicing Rolls Royce
 12 V.
 Terminals ÷ A WL F HI MED LO



234063

Replacing 1861712, -716, 1861A712, -716
Servicing AC172R: 1277480, -490, -500, -510, -520, -530, -600, -620
 24 V.
 Over voltage protection and voltage surge

Volt setting 28.5 V.



136548

Replacing 1861510, -512, 1861A510, -512
Servicing AC203R-115-24-22, -23, AC203R-180-24-15, -16, 1285513, -515, -519, -527, -604, -606, 1885604, -606
 24 V.
 Terminals Black D±, Green DF, Yellow D+, Red B+



139617

Replacing 594A-11, -14, 1861A720, -726
Servicing AC203RA: 1286000, -010, -500, -510, -560, -570, AB207R: 1283232
 24 V.

Also see Diode Chapter
page 780

Replacing CAV

Rectifiers



135582

Replacing 6010-107 (x3)
Servicing AC5B12-5M, -7M, -81,
AC5B24-41, -42, -67, -74, -79, -98M,
AC5R12, AC5RS12, -24

Diodes



139367

Replacing 6270-572F
Servicing AC203R
Positive, Negative, Auxiliary diodes
1/4" - 28 stud



234133

Replacing 6010-238
Servicing AC203RA-115A
Diode kit (3 set required)



133495 A

Replacing 6270-395
70 Amp.
Maximum reverse current 1 milliamp.
400 V.
1/4" - 28 stud. Positive



234134

Replacing 6010-239
Servicing AC203RA-180A
Diode kit (3 set required)



133496 A

Replacing 6270-395A
70 Amp.
Maximum reverse current 1 milliamp.
400 V.
1/4" - 28 stud. Negative

Replacing CAV

Slip Rings



131054 Std pkg 5
Replacing 6220-104
Servicing AC5
 O.D. 31.5 mm, Shaft 14.2 mm, L. 24.5 mm



139391
Replacing 6270-210
Servicing AC203...
 O.D. 42 mm, Shaft 24 mm, L. 25 mm



139392
Replacing 6019-464
Servicing AC7, AC172, AC172R,
 AC203R
 O.D. 25 mm, Shaft 11 mm, L. 28 mm

Brush Boxes



130971
Replacing 6220-477
Servicing AC5B, RS, S, AC203R,
 1263B 020, 1266440, 1266450
 12/24 V. Complete w/ brushes
 For 60 Amp. 3 terminals, Brush: 5.5 x 8 mm
Gasket: Cargo 139733



139390
Replacing 6220-477B
Servicing AC5HER, AC172, AC172R,
 AC203R, 1276500, 1277011, -040, -300
 12/24 V. Complete w/ brushes
 For 140 Amp. 3 terminals, Brush: 5.5 x 8 mm
Gasket: Cargo 139733



139623
Replacing 6270-495
Servicing AC203R..., AC203RA...
 24 V. Complete w/ brushes
 4 terminals, Brush: 5.5 x 10 mm
Gasket: Cargo 139977

Brush Box Parts



139733 Std pkg 5
Replacing 6220-75
Servicing AC5, AC203
 Gasket for brush box

Also see Bearing Chapter
page 821

Replacing CAV

Brush Sets



AX32 2 Std pkg 10
Replacing 6067-69
 6.3 x 7.9 x 13.5 mm
 24 V.



AX33 2 Std pkg 10
Replacing 6067-74
 4.7 x 7.9 x 16.6 mm
 24 V.

Roller Bearings



140445 Std pkg 5
Replacing 6019-670, CRL10A
Servicing AC7
 31.75/69.85 x 17.462 mm
 1.25/2.75 x 0.6875"



140446 Std pkg 5
Replacing 6270-315, N306ECP
Servicing AC203
 30/72 x 19 mm



141044 Std pkg 5
Replacing 6500-173, NU306E.TV92
Servicing AC203RA...
 30/72 x 19 mm

Fan & Pulleys



139741
Replacing 6220-911
Servicing AC5..RS...
 O.D. 140.2 mm, Bore 20 mm
 Fan

Replacing CAV

Repair Kits

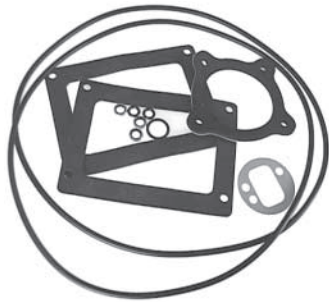

139372

Replacing 6010-30
Servicing AC203



139685

Replacing 6010-235
Servicing CA203RA...



234136

Replacing 6010-237
Servicing AC203RA...
Terminal kit

Sundry Parts



139370

Replacing 6270-43
Servicing AC203
M8 x 52 mm
Positive terminal



139371

Replacing 6270-43A
Servicing AC203
M6/8 x 52 mm
Negative terminal



139384

Replacing 6270-125
Servicing AC203
M8 x 52 mm
Positive terminal



139385

Replacing 6270-125A
Servicing AC203
M6/8 x 52.5 mm
Negative terminal



231530

Replacing 6270-280A
Servicing AC203R
M6/8 x 59.5 mm
Negative terminal



231531

Replacing 6270-280
Servicing AC203R
M8/8 x 56 mm
Positive terminal



139373

Replacing 6221-10
Servicing AC203
80 Amp.
Fuse



139374

Replacing 6221-10B
Servicing AC203
160 Amp.
Fuse

Replacing CAV



139223
Replacing 6270-29
Servicing AC203
 Insulator for heat sink



139379
Replacing 6270-49
Servicing AC203
 8.1 x 18.3 x 39.3 mm
 Insulator



139736 Std pkg 4
Replacing 6220-828
Servicing AC5RS...
 Locator



139375
Replacing 6270-28
Servicing AC203
 Insulator



139386
Replacing 6270-369
Servicing AC203
 Capacitor
 3 µF - 110 V.



233643 Std pkg 10
Replacing NU10-11T1
Servicing AC5RS: 1268580, -660, -690
 1/4" UNF
 Nut



139376
Replacing 6270-28A
Servicing AC203
 Insulator



139387
Replacing 6270-369A
Servicing AC203
 Capacitor
 3 µF - 110 V.



233644
Replacing 5335-807
Servicing AC5RS: 1268580, -660, -690
 1/4" UNC x 71.3 mm, 18.4 mm thread
 Thru bolt



139377 Std pkg 10
Replacing 6270-32
Servicing AC203
 5.5 x 8.5/15 x 15.6 mm
 Insulator



139732 Std pkg 10
Replacing 5293-57
Servicing AC5RS...
 Locking washer



139731 Std pkg 2
Replacing 5337-64B
Servicing AC5RS...
 Screw

Replacing CAV



233645 Std pkg 10

Replacing N37-14Z1

Servicing AC5RS: 1268580, -660, -690

1/4" x 16.2 mm, 13 mm thread

Screw



192591 Std pkg 100

Replacing 5335-963E

Servicing AC203...

M6 x 16 mm, umbraco

Socket head cap screw



192592 Std pkg 100

Replacing 5335-963C

Servicing AC203...

M6 x 25 mm, umbraco

Socket head cap screw

Replacing CHRYSLER

Stators



131414 Reman.
Replacing 3438754
 12 V. 60 Amp.
 O.D. 166.5 mm, I.D. 121.2 mm, W. 12.7 mm



138467
Replacing 4091514, -515, -517
 12 V. 60/78 Amp.
 O.D. 170.7 mm, I.D. 121.1 mm, W. 2.6 mm
 Square back alternators

Brackets D.E.



232400
Replacing 4091402, -424, -533, -534
Servicing 4091563, -565, -566, -568, -572, -727, -797, 4111204, -226, -928, 4176206, 4289689, -975
 Bearing: Cargo 140087



131869 Reman.
Replacing 5226072
Servicing 5226200, 5227100
 12 V. 90 Amp.
 O.D. 144.6 mm, I.D. 105.5 mm, W. 30.3 mm



132073
Replacing 4467155
Servicing 5226457, 5427267
 12 V. 50/120 Amp.
 O.D. 144.6 mm, I.D. 105.8 mm, W. 25.2 mm

Replacing CHRYSLER

Brackets S.R.E.



232404

Replacing 4467156, 5226073
Servicing 5226200, 5227100, -267
Bearing: Cargo 140087
Mounting bushing: Cargo 232405

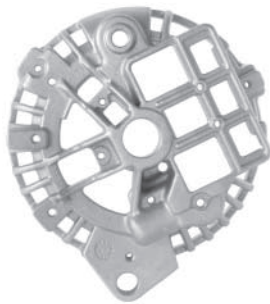

233101

Replacing 4091403, -535, 4111972, -973
Servicing 4091563, -565, -566, -568,
 -572, -727, -795, 4111204, -226, -928,
 4176206, 4289689, -975, 5206971,
 5213053, -079, -540, -541, -762, -763
Needle bearing: Cargo 140120

Bracket Parts



232405

Replacing 5226043
 10 x 14.5 x 29.5 mm
 Mounting bushing, S.R.E.



232771 Std pkg 5

Replacing 4091398
 Bearing retainer

Covers



131927

Replacing 5226002
Servicing 5226200, 5227100
 S.R.E.

Replacing CHRYSLER

Regulators



130504

Replacing 2098300
 Servicing Cargo 110074
 12 V.



131280

Replacing 3438150, CH 537
 Electronic
 60/100 Amp. alternators
 2 fields
 12 V.

Rectifiers



131419

Replacing 3438721
 60 Amp. negative



131420

Replacing 3438727
 60 Amp. positive



131883

Replacing 3755627
 100 Amp. negative



131884

Replacing 3755631
 100 Amp. positive



132071

W/ 50 Amp. diodes
 40/90, 50/120 Amp.
 Terminal post M6-1.0
 Positive / negative



135416

Servicing 5233599, -608, -660, 5234651
 O.D. 110 mm, 8 diodes
 B+ terminal M6

Replacing CHRYSLER

Also see Diode Chapter
page 780



138893

Servicing 4686106
B+ terminal M6



233245

Terminal post M5-0.8
Positive / negative

Diodes



233345 Std pkg 10

25 Amp. 100 V.
1/2" (12.7 mm) press fit
Chrysler hook lead
Positive



233346 Std pkg 10

25 Amp. 100 V.
1/2" (12.7 mm) press fit
Chrysler hook lead
Negative



233347 Std pkg 10

35 Amp. 100 V.
1/2" (12.7 mm) press fit
Chrysler hook lead
Positive



233348 Std pkg 10

35 Amp. 100 V.
1/2" (12.7 mm) press fit
Chrysler hook lead
Negative

Slip Rings

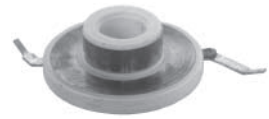

133923 Std pkg 10

O.D. 29.0 mm, Shaft 17 mm, L. 19.0 mm



233935 Std pkg 5

Replacing 4433050, 5226003
O.D. 16.6 mm, L. 45.7/26.4 mm
10.1 mm KNURL O.D.

Replacing CHRYSLER

Brush Boxes



131425 Std pkg 5
Replacing 2095038
Servicing 3438180
 Axial



131426 Std pkg 5
Replacing 3438159
Servicing 3438180
 Radial



135212 Std pkg 10
Replacing 4091667
 Radial



131918
Replacing 5226942
Servicing 5226200, 5227100, 5226457
 Complete w/ brushes
 4 mm brush holder
O-ring: Cargo 232454



131919
Replacing 5226084
Servicing 5226200
 Complete w/ brushes
 5 mm brush holder
O-ring: Cargo 232454



138728
Servicing 4686106
 12 V. Complete w/ brushes



138754
Replacing 5226848
Servicing 4339440, 5226432, 5223574
 12 V. Complete w/ brushes

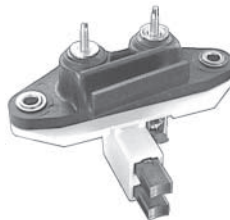

139005
Servicing 4557431, -432, 5234231, -232,
 Chrysler
 12 V. Complete w/ brushes

Brush Sets



EX87R 2 Std pkg 10
Replacing 2084673
 6.1 x 9.5 mm
 12 V.



140809 Std pkg 10
Replacing 2932755, 3420893
 6.1 x 9.5 mm.
 12 V.



140810
Replacing 3755777, -778
 7.95 x 9.55 mm
 12 V.



141162
Replacing 4091427, -426, -445
 6 x 9.5 x 19 mm

Replacing CHRYSLER

Also see Bearing Chapter
and Pulley Survey



141163

Replacing 5206920, -923, -926, -964
6 x 9.5 x 19 mm
8-32 threaded terminals



141164

6 x 6 x 13 mm

Needle Bearings



140240 Std pkg 10 A

Replacing CN-1467
17/23.8 x 17.4 mm
Open end



140241 Std pkg 10

Replacing 1975322, 3874074
100 Amp. alternators
17/23.8 x 20.6 mm
Closed end

Fan & Pulleys



134005

Replacing 5226458
O.D. 147 mm, Bore 17 mm
Fan



134006

Replacing 5226032
O.D. 69.4 mm, Bore 17 mm, W. 21.2 mm,
4 grooves



134007

Replacing 5227174
O.D. 73.7 mm, Bore 17 mm, W. 32.2 mm,
Double



136452

Servicing 5233449, -660, -949, -973,
5234029, -260
O.D. 63.1 mm, Bore 17 mm, W. 28.4 mm,
5 grooves

Also see Pulley Survey
page 809

Replacing CHRYSLER



136453

Servicing 5233599, -672, -673, 5234028, -199
O.D. 72.1 mm, Bore 17 mm, W. 34.1 mm, Double



232076

Replacing 2098272
O.D 81.3 mm, Bore 17 mm, W. 54.6 mm, Double, B-belt type

Sundry Parts



131923 Std pkg 5

Replacing 5226148
Servicing 40/90, 50/120 Amp. alternators
Stator leads insulator



136454

Servicing 4557301, 5233418, -608, 5234031, -201, -208
O.D. 62.9 mm, Bore 17 mm, W. 23.9 mm, 4 grooves



232077

Replacing 3656571, 4091895, 4111768
O.D 67.5 mm, Bore 17 mm, W. 53.3 mm, Double



131925

Replacing 5226087
Servicing 40/90, 50/120 Amp. alternators
W/ 5 mm mounting holes
Terminal block



230180

Servicing 5213756, -847, 5226432, -600, 5233574, -718
O.D. 67.3 mm, Bore 17 mm, W. 29.8 mm, 4 grooves



232078

Replacing 4339481, 5213564, -760
O.D 66.9 mm, Bore 17 mm, W. 36.3 mm, 4 grooves



131926

Replacing 4433144
Servicing 40/90, 50/120 Amp. alternators
W/ 4 mm mounting holes
Terminal block



232075

Replacing 2095430, 2444478, 4106094
O.D 75 mm, Bore 17 mm, W. 38.2 mm, Single, B-belt type



232079

Replacing 5227468
Servicing 5233160
O.D 69.7 mm, Bore 17 mm, W. 26.9 mm, 5 grooves



231893

Servicing 4686098, 4727220
Terminal block

Replacing CHRYSLER

Also see O-ring Survey
page 854



232454 Std pkg 5

Replacing 6032831

39.3 x 2.6 mm (1-9/16" x 3/32")

O-ring for Brush box

Replacing DELCO Eur.

Rotors



131632

Replacing 3472421

Servicing 3472018, -022

12 V. 55 Amp.

L. 163 mm, O.D. 96 mm, Shaft 17 mm



131671

Replacing 3472671

Servicing 3472050

12 V. 55 Amp.

L. 153 mm, O.D. 96 mm, Shaft 17 mm

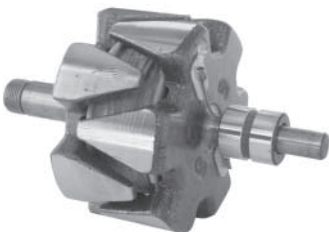

131681

Replacing 3472790

Servicing 3472058, -059, -065, -067

12 V. 45 Amp.

L. 155 mm, O.D. 92 mm, Shaft 17 mm



131682

Replacing 3472791

Servicing 3472061, -068, -204, -208

12 V. 55/70 Amp.

L. 153.3 mm, O.D. 92 mm, Shaft 17 mm



138052

Servicing CS130D, 3493214, 10479214

12 V. 100/105 Amp.

L. 148.7 mm, O.D. 96 mm, Shaft 17 mm



139402

Replacing 10475022, -523

Servicing CS130D, 3493814, 3493823,

10479914, -923, -947, -955

12 V. 70/100 Amp.

L. 153 mm, O.D. 96 mm, Shaft 17 mm

Rotor Parts



132346 Std pkg 10 A

Replacing 2909321

.668" - 20 x 15/16"

Rotor shaft nut

Replacing DELCO Eur.

Stators



130268

Replacing 3472330
Servicing 3472002, -014, -052, -053
 12 V. 45 Amp.
 O.D. 131.8 mm, I.D. 96.6 mm, W. 23.7 mm



131307

Replacing 3472745
Servicing 3472061, -068, -204, -208
 12 V. 55 Amp.
 O.D. 128 mm, I.D. 92.6 mm, W. 26.6 mm



137052

Replacing 10475030, 10475450
Servicing CS130D, 3493214, 10479214
 12 V. 100/105 Amp.
 O.D. 129.9 mm, I.D. 96.5 mm, W. 25.3 mm



130269

Replacing 3472429
Servicing 3472018, -022, -050
 12 V. 55 Amp.
 O.D. 130.8 mm, I.D. 96.5 mm, W. 23.7 mm



133927

Replacing 10495208, 10497320
Servicing 1101196, 1101199, 1101551
 12 V. 61/74 Amp.
 O.D. 121.6 mm, I.D. 88.8 mm, W. 20.3 mm



131306

Replacing 3472744
Servicing 3472058, -059, -065, -067
 12 V. 45 Amp.
 O.D. 127.9 mm, I.D. 92.6 mm, W. 24.8 mm



135611

Replacing 3493014, 3493138
Servicing 3472121, -130, -134, -137, -144, 3493606, -621, -634, -641, -644, -706
 12 V. 70 Amp.
 O.D. 128.1 mm, I.D. 92.4 mm, W. 26.5 mm

Replacing DELCO Eur.

Brackets D.E.



134387

Replacing 3472681
 Servicing 3472051, -053
 Bearing: Cargo 140087



136749

Replacing 10475013
 Servicing 10479923, -947
 Bearing: Cargo 140093

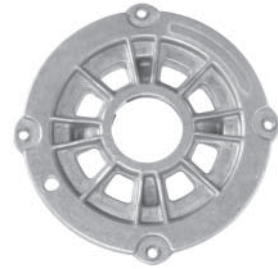

234659

Replacing 10451525
 Servicing 10480403, -407
 Bearing: Cargo 140263



134388

Replacing 3472449
 Servicing 3472022, -024, -028, -037, -038, -049
 Bearing: Cargo 140087



231699

Replacing 10475133
 Servicing 10479955
 Bearing: Cargo 140093



136747

Servicing 1101199
 Bearing: Cargo 140087



231939

Servicing 10479214, -215, 1080214, -215
 Bearing: Cargo 140093

Replacing DELCO Eur.

Brackets S.R.E.

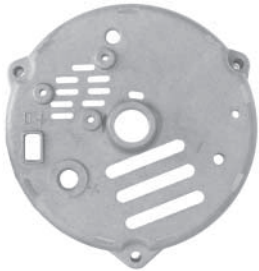

134389

Replacing 3472571
 Servicing 3472022, -024, -028, -032, -033, -037, -038, -048, -049, -050, -051, -052, -053



135946

Replacing 3493200
 Servicing 3472104, -105, -106, -119, -120, -121, -128, -130, -134, -135, -136, -137, -139, -142, -143, -144, -604, -606, -619, -620, -634, -635, -639, -644, -704, -706

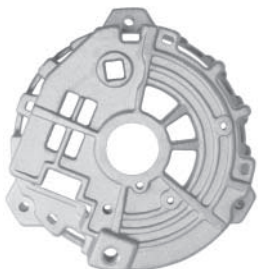

136748

Servicing 1101199



136750

Replacing 10475007
 Servicing 10479923, -947



234932

Servicing 10480214, -215
 Bearing: Cargo 140084



235117

Replacing 3472878
 Servicing 3472059, -061, -082, -104, -105, -106, -139, -204, 3472706, 3493139, -204, -239, -604, -606, -639, 3493714, -716, -739
 Bearing: Cargo 140093



Bracket Parts



133929 A

Servicing 1101196, 1101199, 1101551
 Cover, S.R.E. Bracket



138435 Std pkg 5

Servicing 3472170, -171
 10.2 x 14.0/22.0 x 17.8 mm
 Mounting bushing, S.R.E.



138436 Std pkg 5

Servicing 3472170, -171
 14 x 19.2 x 12.7 mm
 Mounting bushing, S.R.E. rubber



232742

Servicing CS130D: 3493814, -823, -847, -855, 10479914, -923, -947, -955
 10 x 16-22 x 20 mm
 Mounting bushing, S.R.E.

Replacing DELCO Eur.



134428 Std pkg 5 **A**
Servicing 1101551
 O.D. 29.2 mm, I.D. 27 mm, L. 25.8 mm
 Bearing cap



232635 Std pkg 5
Servicing CS130D
 O.D. 37 mm, I.D. 35 mm, L. 12.7 mm
 Bearing cap



136296 Std pkg 10
 O.D. 39.1 mm, I.D. 33 mm, Th. 0.5 mm
 For 6203 Bearing
 Bearing spring

Covers



136596
Replacing 10475017
Servicing CS130D: 3493947, 10479914,
 -923, -947, -955



138879
Servicing 10479214, Renault Clio



234066
Servicing 10480403, -404

Regulators

Volt setting 14.7 V.



130664
Replacing 7982614
Servicing 7934505, 7982572, 7982575,
 7982600, 7982601, 7982604, 7982614
 12 V.

Volt setting 14.7 V.



130666
Replacing 7982685
Servicing 7982674, 7982675, 7982685,
 7982698, 7982699, 7982703, 7982704,
 7982705, 7982707, 7982710
 12 V.

Volt setting 14.7 V.



130668 A
Replacing 1116380, DR 600
Servicing 3472004, -008, -014, -018,
 -022
 Type 100 - 205 serie
 12 V.

Replacing DELCO Eur.

Volt setting 14.7 V.



131044

Replacing 3472557

Servicing 3472020, -021, -028, -032, -033, -037, -038, -042, -048, -049, -050, -051, -052, -053, -058, -059, -060, -061
Opel, Vauxhall
12 V.

Volt setting 14.7 V.



133073

Replacing 9345333

Same as Cargo 131044 but with long sensing pin
12 V.

Volt setting 14.5 V.



135162

Same as Cargo 131044
12 V.

Volt setting 14.8 V.



132929

Replacing 3493079

Servicing Opel, Vauxhall
12 V. 5 Amp. field
White plastic base
Use only w/ rectifier Cargo 131458

Volt setting 14.7 V.



133589

Replacing 1116432, 16148399

Servicing 1101196, 1101199
12 V.
L. Terminals drives choke soft start

Volt setting 14.5 V.



135163

Same as Cargo 130668
12 V.

Volt setting 14.8 V.



132930

Replacing 3493080

Servicing Opel, Vauxhall
12 V.
8 Amp. field
Black plastic base
Use only w/ rectifier Cargo 132931

Volt setting 14.7 V.



134343

Replacing 1116424

Servicing 1101551
12 V.
L. Terminals drives choke

Volt setting 14.6 V.



135336

Replacing 10475019, 19009701

Servicing CS130D: 10479914, -923, -947, -955
12 V.

Replacing DELCO Eur.

Rectifiers

Volt setting 14.6 V.



135547

Replacing 19009702
Servicing CS130D, 3493214, 10479214
 Renault
 12 V.
 No. 466 on regulator case
 2.5 sec. CRC. P-L-I-S

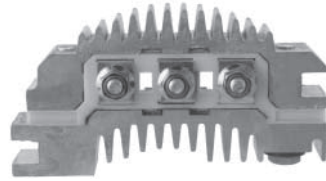

130665

Replacing 7982772
Servicing 7982574, 7982575, 7982600,
 7982601, 7982604, 7982605
 3 screw and 2 spade terminals



131880

Replacing 1989658
Servicing 1101196, 1101199, 1101551
 Use heat transfer compound Cargo 200618
 Cover: Cargo 132047

Volt setting 14.6 V.

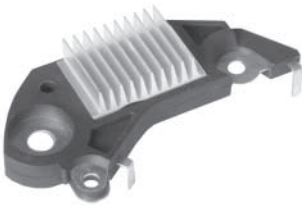

231796

Replacing 10493240, 19009708
Servicing CS130D
 Opel
 12 V.
 10 Sec. LTC
 Soft start

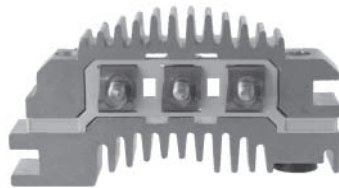

130667

Replacing 3472311, 7982716, DR3900
Servicing 3472002, -004, -008, -014,
 -018, -022, -023, -024, -025, -026, -027,
 -028, -032, -037, -038
 3 screw terminals

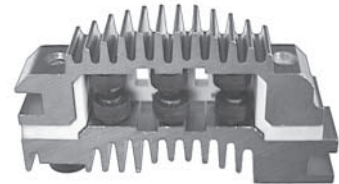

132672

Replacing 3472820, 3478627
Servicing 3472020, 3472021, 3472063,
 3472064
 Spade terminals 6.3 mm

Volt setting 14.6 V.



233596

Servicing 3493273, 19009708
 12 V.
 10 Sec. LTC
 Soft start

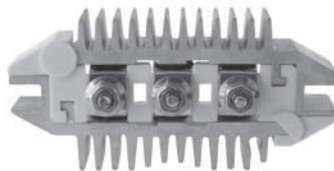

131458

Replacing 3472813
Servicing 3472057, -058, -059, -060, -061,
 -062, -065, -066, -067, -068, -069, -070
 25 Amp. diodes
 (Use only w/ regulator Cargo 132929)
 White plastic base

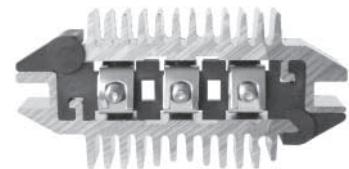

132931

Replacing 3493008
Servicing 3472106, -121, -130, -134,
 -137, -144
 50 Amp. diodes
 H.D. (Use only w/ regulator Cargo 132930)
 Black plastic base

Replacing DELCO Eur.



135337

Servicing CS130D, 3493214, 10479214
Renault
B+ terminal M8 x 33 mm
Use heat transfer compound: Cargo 200618

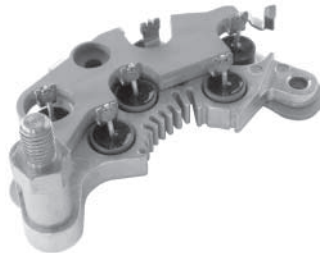

231797

Replacing 10493596
Servicing CS130D
Opel, Vauxhall
W/o diode trio
B+ terminal M8 x 13 mm
Use heat transfer compound: Cargo 200618

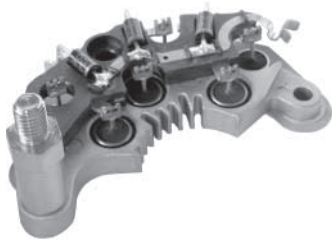

136595

Replacing 10475034
Servicing CS130D: 3493947, 10479914,
-923, -947, -955
B+ terminal M8 x 35 mm
Use heat transfer compound: Cargo 200618

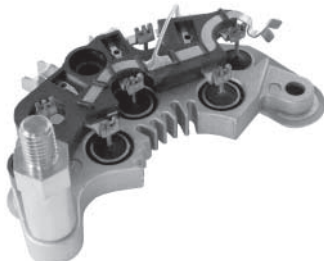

231762

Servicing 3493273
B+ terminal M8 x 36 mm
W/o diode trio

Rectifier Parts



132047 Std pkg 5 A

Servicing 1101196, 1101199, 1101551
Opel, Vauxhall
Cover for rectifier Cargo 131880



133198 Std pkg 10 A

M6 x 50 mm
B+ Terminal



138049

Replacing 10475038
Servicing CS130D
M8-1.25 x 46 mm
B+ terminal



138673 Std pkg 5

Replacing 10475020
Servicing CS130D, 3493923, 3493955,
10479914, -923, -947, -955
M5-M8 x 45 mm
D+ Terminal

Replacing DELCO Eur.

Diode Trios



130674 Std pkg 5 **A**
Replacing DR3901, 1984032
Servicing Opel, Vauxhall
 Black case



132611 HD Std pkg 5 **A**
Replacing DR3901, 3472312
Servicing Opel, Vauxhall

Slip Rings



130843 Std pkg 10 **A**
Replacing 92100510
Servicing 3472002, -004, -008, -014, -018
 O.D. 22.5 mm, Shaft 12 mm, L. 24.4 mm



133924 Std pkg 10 **A**
Servicing 1101196, 1101199, 1101551
 O.D. 26.4 mm, Shaft 13.2 mm, L. 23.8 mm



136682 Std pkg 5
Servicing CS130D
 O.D. 14.7 mm, Shaft 7.1 mm, L. 20.3 mm

Brush Boxes



130712
Replacing DR701
Servicing 3472002, -004, -008, -014
 12 V. Complete w/ brushes



130973
Replacing 7982589
Servicing DN 460, 7982575, 7982574
 12 V. Complete w/ brushes



131915 **A**
Servicing 1101196, 1101199, 1101551
 12 V. Complete w/ brushes



136599
Replacing 10475011
Servicing CS130D: 3493947, 10479914, -923, -947, -955
 12 V. Complete w/ brushes

Replacing DELCO Eur.



137053

Servicing CS130D, 10479214, -215
12 V. Complete w/ brushes



234067

Servicing 10480403, -404
12 V. Complete w/ brushes

Brush Box Parts



134870 Std pkg 10 **A**

Replacing 3472506
Servicing 3472..., RX103F 2
Brush spring

Brush Sets



140598 **A**

Servicing 1101196, 1101199, 1101551
Opel, Vauxhall
5 x 8 x 22.5 mm
12 V.



140912

Servicing CS130D, 10479214, -215
4.5 x 8.0 x 22.0 mm
12 V.



141033 Std pkg 10

Servicing CS130D
4.5/8 x 20-23 mm
12 V.



RX103E 2 Std pkg 10 **A**

Replacing 7982543
5 x 8 x 13.2 mm
12 V.

Also see Bearing Chapter
and Pulley Survey

Replacing DELCO Eur.

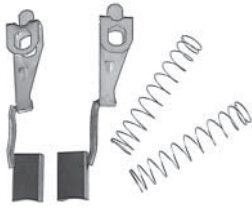

RX103F 2 Std pkg 10 **A**
Replacing DR702
Servicing Opel, Vauxhall
 5 x 8 x 13.2 mm
 12 V.

Needle Bearings



140115 Std pkg 10 **A**
Replacing 3472455
Servicing Opel, Vauxhall
 11.5/17.5 x 16.5 mm

Fan & Pulleys



133537
Replacing 3472419
Servicing 3472020, -21, -28, -32, -33,
 -37, -38, -42, -48, -49, -63, -64
 O.D. 130 mm, Bore 17 mm



139045
Replacing 3472807
Servicing 3472...
 O.D. 128 mm, Bore 17 mm



135531
Replacing 3493115, 3493316
Servicing 3472170, -172
 O.D. 55 mm, Bore 17 mm, W. 26.8 mm,
 5 grooves



136364
Replacing 3472808
Servicing 3472057, -058, -059, -060, -061,
 -062, -065, -066, -067, -068, -069, -070,
 -072, -073, -082, -091, -104, -105, -106
 O.D. 71.4 mm, Bore 17 mm
 Single

Replacing DELCO Eur.

Also see Pulley Survey page 809



136601

Replacing 10475021
Servicing CS130D, 10479923, -947
 O.D. 50 mm, Bore 17 mm, W. 33.1 mm,
 6 grooves



210843

Tool to be used for mounting and
 dismantling of free wheel pulleys
 Shaft L. 74 mm.

210948

As Cargo 210843, but
 Shaft L. 114 mm.

Repair Kits

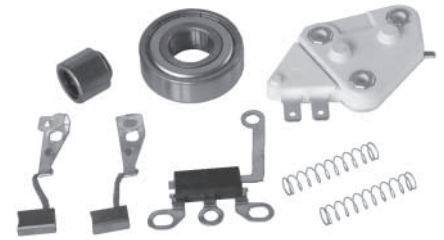

133319

Include 130668 regulator,
 130674 diode trio, 140088 bearing,
 140115 needle bearing, RX103F 2 brush set



137369

Replacing 3472539
Servicing 3472020, -021, -028, -032,
 -033, -037, -038, -042, -048, -049, -050,
 -051, -052, -053
 O.D. 68 mm, Bore 17 mm, W. 16.5 mm,
 Single



133984

Include 130666 regulator,
 130674 diode trio, 140088 bearing,
 140115 needle bearing, RX103F 2 brush set
 12 V.



230526

Replacing 10484670
Servicing Opel
 O.D. 56.7 mm, Bore 17 mm, W. 35.2 mm,
 6 grooves, w/ Free wheel
Pulley tool: Cargo 210843

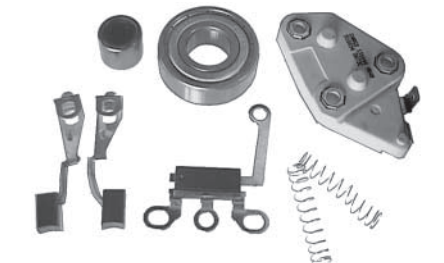

135352

Include 131044 regulator,
 130674 diode trio, 140088 bearing,
 140115 needle bearing,
 RX103F 2 brush set
 12 V.



231673

Servicing 3493273
 O.D. 62.5 mm, Bore 17 mm, W. 21 mm,
 Single

Also see Pulley Survey
page 773

Replacing DELCO Eur.

Sundry Parts



136241

Include 132930 regulator
130674 diode trio, 140088 bearing,
140115 needle bearing,
RX103F 3 brush set



133928 A

Servicing 1101196, 1101199, 1101551
M5-0.8 int. M6-1.0 ext.
B+ terminal kit



137054

Replacing 10475012
Servicing CS130D: 3493947, 10479914,
-923, -947, -955
Stator lead



134077 Std pkg 10 A

Servicing 1101199, 1101551
M4-0.7 x 21 mm, E5 torx
Screw



191307 Std pkg 10

Replacing 1989649
Servicing 1101199, 1101551
M5-0.8
Hex nut



133497 Std pkg 5 A

Replacing 3493057
Servicing 3472104, -105, -106, -112, -119,
-120, -121, -134, -135, -136, -137, -139
Insulator



134327 Std pkg 5

Servicing 1101551
Insulator for B+ and D+



135524 Std pkg 5

Replacing 3493066
Servicing 3493641
Insulator



135763 Std pkg 5

3.7/11.4 x 13.8 mm
Insulator



132581 Std pkg 10 A

5 x 9/14 x 4 mm
Insulator bushing

Replacing DELCO Eur.



132582 Std pkg 10 **A**
6.35 x 14.73/15.08 x 6 mm
Insulator bushing



134140 Std pkg 10 **A**
B+ to regulator
Old style
Connector

Replacing DELCO Korea

Rotors



232803

Replacing 10495197, 10497317
Servicing CS121: 219091, 10480000, 96109301, -302
 12 V. 85 Amp.
 L. 149.5 mm, O.D. 88.5 mm, Shaft 17 mm



233390

Servicing 219187, 96224431, 96252551
 12 V. 85 Amp.
 L. 150.7 mm, O.D. 88.5 mm, Shaft 17 mm

Stators



232802

Servicing CS121: 219091, -99, 10480000, -73
 12 V. 80 Amp.
 O.D. 118 mm, I.D. 89 mm, W. 20.2 mm



233391

Servicing 219187, 96224431, 96252551
 12 V. 85 Amp.
 O.D. 118 mm, I.D. 89 mm, W. 22.7 mm

235259

Servicing 96314258, AB165104
 12 V, 65 Amp,
 O.D. 112 mm, I.D. 90 mm, W/ 20 mm



Brackets D.E.

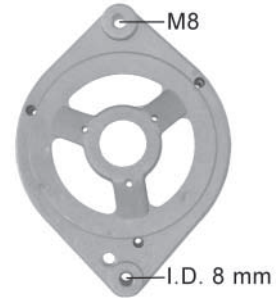

139873

Replacing 10498009
Servicing 10480000, 96109301, -302
 Bearing: Cargo 140087



139874

Replacing 210302
Servicing 00219091, 00219099, 10480073, 96224432
 Bearing: Cargo 140087

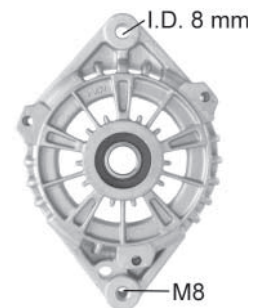

233392

Replacing 210667
Servicing 219187, 96224431, 96252551
 W/ bearing

Replacing DELCO Korea

Brackets S.R.E.

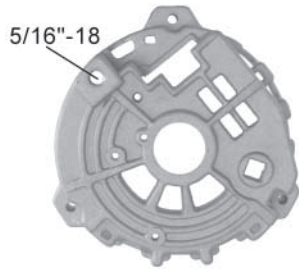

139869

Replacing 10496053
 Servicing 00219091, 96224432

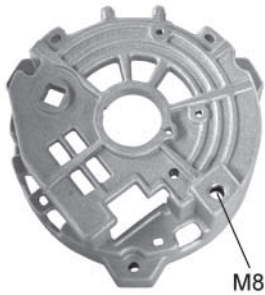

139870

Replacing 10469984

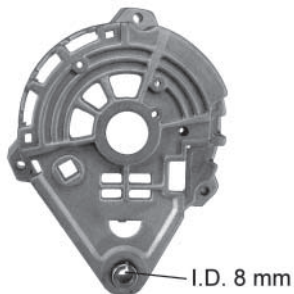

139871

Replacing 10498011
 Servicing 00219099, 10480000,
 10480073



233393

Servicing 219187, 96224431, 96252551
 Bearing: Cargo 140271

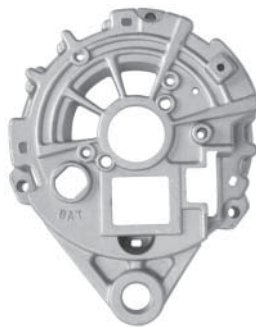

234337

Replacing 210930
 Servicing 219138, -139, -202
 Bearing: Cargo 140271

Bracket Parts



139875 Std pkg 5

Replacing 10476121
 Servicing 96224431
 Cover for S.R.E. bearing

Replacing DELCO Korea

Covers



233660

Servicing 219170, 96380673

Regulators

Volt setting 27.7 V.



138387

Replacing 273110, 273310

Servicing 219081, 219072, 10220350, 102203500, 102203510, Daewoo - Samsung 24 V.



230915

Servicing 21EA00050, Cargo 111647 24 V.

Volt setting 14.7 V.

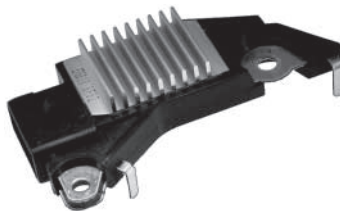

139467

Replacing 276010

Servicing 96224431, -432, Daewoo 12 V.

Volt setting 14.1 V.



233975

Replacing 271940

Servicing 19020600, -601, -604, -606, -608, -609, -611, -612, -614, -615, -616 12 V. Terminals S-L

Volt setting 14.6 V.

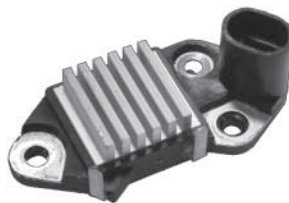

139468

Replacing 271710

Servicing 96380673 Daewoo Matiz 12 V.



234306

Replacing IAT 09750

Servicing 96206871, 96341300 12 V.

Replacing DELCO Korea

Rectifiers



132462

Replacing 37367-83000, -83100
Servicing 21EA00050, Cargo 111647
 O.D. 116 mm
 W/ diode trio and capacitor



138389

Replacing 267000
Servicing Daewoo - Samsung
 8 - 30 Amp. diodes
 W/ diode trio
Use heat transfer compound: Cargo 200618



230983

Replacing 10475039
Servicing CS 130
 6 - 25 Amp. diodes
 W/ diode trio



233447

Servicing 219139, 96303556



234307

Replacing IAT 08790
Servicing 96206871, 96341300



235139

Replacing 266600
 6 - 50 Amp. diodes
 B+ terminal: M6



Rectifier Parts



233414 Std pkg 10
Servicing 219170, 96380673
 M4-0.7 x 18 mm
 Fixing screw for rectifiers

Also see Pulley Survey
page 809

Replacing DELCO Korea

Brush Boxes



231346

Servicing CS121D: 96224431, -432, 96252551
12 V.
Complete w/ brushes



233449

Servicing 219139, 96303556
12 V.
Complete w/ brushes



234308

Servicing 96206871, 96341300
12 V.
Complete w/ brushes

Brush Sets



141085

Servicing 96224431, -4432
5.2 x 9.2 x 18 mm
12 V.



141195

Servicing 219170, 96380673
5 x 8 x 25 mm
12 V.

Fan & Pulleys



234477

Replacing 93740821
Servicing 219137, -139, -187, -199, 96224431, 96252551, 96303556
O.D. 87 mm, Bore 17 mm



230008

Replacing 10497325
Servicing 00219091, 96224432
O.D. 58.6 mm, Bore 17 mm, W. 43.7 mm,
5 grooves



230307

Replacing F-229363.6
Servicing 10480403, Mercedes
O.D. 50 mm, Bore 17 mm, W. 35.1 mm,
6 grooves, w/ Free wheel
Pulley tool: Cargo 210843



230526

Replacing 10484670, F-230753.06
Servicing Opel
O.D. 56.7 mm, Bore 17 mm, W. 35.2 mm,
6 grooves, w/ Free wheel
Pulley tool: Cargo 210843

Replacing DELCO Korea

Also see Pulley Survey page 809

Sundry Parts



230527

Replacing OK588-18-W11, F-231618.05
Servicing Kia
 O.D. 59.7 mm, Bore 17 mm, W. 32.7 mm,
 5 grooves, w/ Free wheel
Pulley tool: Cargo 210843



230718

Replacing 10467039
Servicing 00219099, 10480000,
 10480073, 96224431
 O.D. 50.1 mm, Bore 17 mm, W. 42.6 mm,
 5 grooves

235294

Servicing 219170, -251
 O.D. 69 mm, Bore 17 mm, W. 18 mm,
 Single



210843

Tool to be used for mounting and
 dismounting of free wheel pulleys
 Shaft L. 74 mm.

210948

As Cargo 210843, but
 Shaft L. 114 mm.



231361

Servicing CS121D: 96224431
 Cover, stator leads



233389

Servicing 219187, 96224431, 96252551
 Cover, stator leads



231359

Replacing 10495213
Servicing CS121: 0219099, 96109302,
 10480000, -073
 O.D. 114 mm
 Baffle



231360

Servicing CS121D: 96224431
 O.D. 114 mm
 Baffle



233388

Servicing 219187, 96224431, 96252551
 O.D. 113.4 mm
 Baffle



233448

Servicing 219139, 96303556
 O.D. 114.5 mm
 Baffle



233394

Servicing 219187, 96224431, 96252551
 M6 x 11 mm / M5 x 10 mm
 B+ terminal



232992 Std pkg 10

M4-0.7 x 22.5 mm. E5 torx
 Fixing screw for regulator

Replacing DELCO US

Rotors



130527 Reman.
Replacing 1971990
Servicing 10 SI
 12 V. 61 Amp.
 L. 163 mm, O.D. 104 mm, Shaft 17 mm

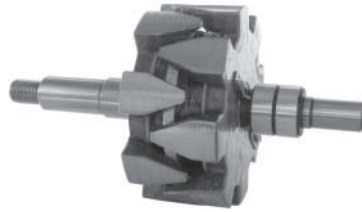

138127
Replacing 1978873
Servicing 27 SI
 24 V. 65 Amp.
 L. 218 mm, O.D. 117 mm, Shaft 22/25 mm
Seal: Cargo 232743

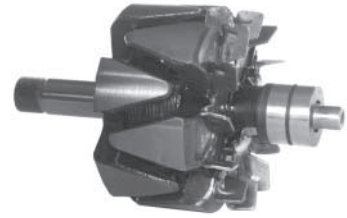

232803
Replacing 10470887, 10472665
Servicing CS121
 12 V. 85 Amp.
 L. 149.5 mm, O.D. 88.5 mm, Shaft 17 mm



137132
Replacing 1989632, 10470297
Servicing CS130
 12 V. 100/105 Amp.
 L. 149.5 mm, O.D. 95.8 mm, Shaft 17 mm

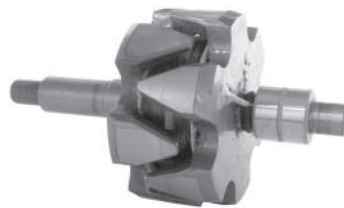

138129
Replacing 10470690
Servicing 21 SI
 24 V. 50/70 Amp.
 L. 200.4 mm, O.D. 107.8 mm, Shaft 22/25 mm
Needle bearing: Cargo 140772



232813
Replacing 1985476, 10475405
Servicing 12SI: 10480005, 1100203,
 -204, -206, -207, -208, -225, -226, -227,
 -228, -229, -230, -231, -232, -233, -234
 12 V. 78/94 Amp.
 L. 163 mm, O.D. 104 mm, Shaft 17 mm



138052
Replacing 10475748
Servicing CS130D
 12 V. 100/105 Amp.
 L. 149 mm, O.D. 96 mm, Shaft 17 mm



138771
Replacing 1975333
Servicing 15 SI - Type 116
 12 V. 97/105 Amp.
 L. 167 mm, O.D. 107 mm, Shaft 17 mm
Inner race: Cargo 141111

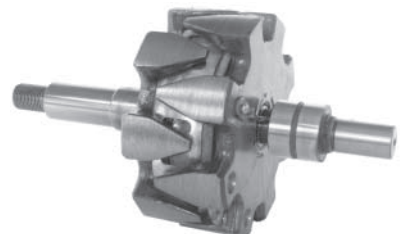

232815
Replacing 1852040, 1972914, 1978872
Servicing 27SI: 1100072, -073, -075,
 -076, -080, -081, -082, -083, -086, -087
 12 V. 65/100 Amp.
 L. 220 mm, O.D. 116.5 mm, Shaft 22.23 mm
Seal: Cargo 232743

Replacing DELCO US



232816

Replacing 1977380, 1978877
Servicing 27SI/205: 1100094, -095, -096, -216
 12 V. 65/100 Amp. W/ extended shaft
 L. 271 mm, O.D. 116 mm, Shaft 22.23 mm, 23 Splines
Seal: Cargo 232743



232819

Replacing 10471616, 10472724
Servicing CS144: 1102616, 10479817, -895, 10480018, -019, -023, -077, -111
 12 V. 124/145 Amp.
 L. 166.5 mm, O.D. 107.4 mm, Shaft 17 mm
Needle bearing S.R.E.: Cargo 140773



232822

Replacing 10493722
Servicing 22SI
 12 V. 145 Amp.
 L. 210 mm, O.D. 108 mm, Shaft 22.23 mm



232817

Replacing 10470798, 10476606
Servicing CS144: 10479809, -836, -838, -839, -843, -844, -847, -853, -854, -855
 12 V. 108/124 Amp.
 L. 160 mm, O.D. 107 mm, Shaft 17 mm
Bearing S.R.E.: Cargo 141002



232820

Replacing 10477018, 10477782
Servicing 21SI: 19010100, -114, -115, -118, -120, -124, -126, -127, -129, -134
 12 V. 90/160 Amp.
 L. 209.5 mm, O.D. 107.7 mm, Shaft 22.23 mm
Needle bearing: Cargo 140136



232823

Replacing 10477863
Servicing 21SI: 19010108, -111, -182
 24 V. 50/70 Amp.
 L. 210 mm, O.D. 108 mm, Shaft 22.23 mm
Needle bearing: Cargo 140136



232818

Replacing 10467263, D3186
Servicing 21SI: 1117839, -880, -885, -886, -887, -890, -891, -892, -894, -895
 12 V. 90/160 Amp.
 L. 201 mm, O.D. 108 mm, Shaft 22.23 mm
Needle bearing: Cargo 140772



232821

Replacing 10492756
Servicing 22SI
 12 V. 100 Amp.
 L. 210 mm, O.D. 108 mm, Shaft 22.23 mm



232824

Servicing CS121D: 21023969, 21024727
 12 V. 90 Amp.
 L. 150.4 mm, O.D. 88.3 mm, Shaft 17 mm

Replacing DELCO US

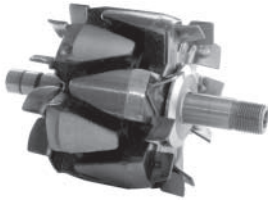

233370

Servicing AD230, CS130D
12 V. 110 Amp.
L. 149 mm, O.D. 96 mm, Shaft 17 mm

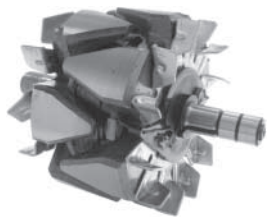

233664

Servicing AD237
12 V. 125 Amp.
L. 152 mm, O.D. 105.2 mm, Shaft 17 mm



234339

Servicing AD244 series
12 V. 130/145 Amp.
5.2 Amp. draw
L. 152.5 mm, O.D. 107.3 mm, Shaft 17 mm
Used w/ Stator: Cargo 234340

234341

Servicing AD244 series
12 V. 130 Amp.
7.5 Amp. draw
L. 152.5 mm, O.D. 107.3 mm, Shaft 17 mm
Used w/ Stator: Cargo 233665

Rotor Parts



230026

Replacing 1894474
Servicing 20 SI
24 V. 35 / 45 Amp.
Stationary coil



230027

Replacing 1969133
Servicing 25 SI: 40/55 Amp.,
26 SI: 50/75 Amp.
24 V.
Stationary coil



230028

Replacing 1876768
Servicing 30 SI
24 / 32 V. 60 Amp.
Stationary coil

Replacing DELCO US



232808

Replacing 1894492
Servicing 20SI: 1117611, -612, -616, -618, -621, -641
 12 V. 60 Amp.
 Stationary coil



232811

Replacing 10491238
Servicing 33SI, 34SI: 19011150, -151, -152, -154, -155, -156, -157, -158, -159, -160, -161, -162, -163, -167, -169, -170
 12 V. 135 Amp.
 Stationary coil



232743

Std pkg 5
Replacing 1961323, -523, 1986538
Servicing 10DN, 10SI, 27SI/200
 17.5 x 23.1 x 4.6 mm
 (0.69" x 0.91" x 0.18")
 Used on rotor w/ 0.688" shaft
 Seal



232809

Replacing 1968916
Servicing 25SI, 26SI: 10459003, -005, 1117155, -225, -227, -228, -231, -232, -234, -235, -240, -241, -242, -244, -245
 12 V. 75 Amp.
 Stationary coil



132346

Std pkg 10 **A**
Replacing 1915172
Servicing 10 DN, 10 SI etc.
 .668" - 20 x 15/16"
 Rotor shaft nut



232747

Std pkg 5
Replacing 1970384
Servicing 27SI/200
 25.1 x 33.5 x 14.5 mm
 Spacer for rotor



232810

Replacing 1876790, 1974630
Servicing 29SI, 30SI: 10459004, -008, -009, -010, 1117067, -068, -160, -161, -162, -164, -165, -481, -482, -483, -484
 12 V. 105/110 Amp.
 Stationary coil



232741

Std pkg 5
Servicing 10DN, 10SI, 27SI/100
 18.5 x 23.1 x 4.6 mm
 (0.73" x 0.91" x 0.18")
 Used on rotor w/ 0.728" shaft S.R.E.
 Seal



232751

Servicing CS121D, 21023969, 21024727
 17 x 46.7 x 10.2 mm
 Spacer for rotor

Replacing DELCO US

Stators



130525 Reman.
Replacing 1971986
Servicing 10 DN
 12 V. 61 Amp.
 O.D. 140.8 mm, I.D. 105.2 mm, W. 20 mm



131855 Reman.
Replacing 1984445
Servicing 12 SI
 12 V. 66/78 Amp.
 O.D. 140.4 mm, I.D. 104.5 mm, W. 24.4 mm



131859 Reman.
Replacing 1988989
Servicing 17 SI
 12 V. 120 Amp.
 O.D. 144.6 mm, I.D. 107.7 mm, W. 27.6 mm



130526 Reman.
Replacing 1971639
Servicing 10 SI, 1102451
 12 V. 61 Amp.
 O.D. 140.4 mm, I.D. 103.7 mm, W. 19.3 mm



131856 Reman.
Replacing 10497041, 1987074
Servicing 12SI: 1101134, -240, -241, -245, -299, -301, -302, -304, -305, -308
 12 V. 94 Amp.
 O.D. 140.3 mm, I.D. 105 mm, W. 24.5 mm



131860 Reman.
Replacing 1894490
Servicing 20 SI
 12 V. 60 Amp.
 O.D. 140.9 mm, I.D. 104.7 mm, W. 19.8 mm



130528
Replacing 801818, 1852033
Servicing 27 SI, 1100080, 1100077, 1100083
 12 V. 85 Amp.
 24 V. 65 Amp.
 O.D. 158.2 mm, I.D. 116 mm, W. 25.3 mm



131858 Reman.
Replacing 1987510
Servicing 15 SI, 17 SI
 12 V. 108 Amp.
 O.D. 150 mm, I.D. 108 mm, W. 31.2 mm



131861 Reman.
Replacing 1974548
Servicing 20 SI
 24 V. 45 Amp.
 O.D. 140.6 mm, I.D. 104.5 mm, W. 23.9 mm

Replacing DELCO US



131862

Replacing 1968892
Servicing 25 SI, 26 SI
 12/24 V. 75 Amp.
 O.D. 158.1 mm, I.D. 116.1 mm, W. 25.2 mm
Grommet: Cargo 232685



132045 Reman.

Replacing 1876769, 1988085
Servicing 29 SI, 30 SI
 24 V. 60 Amp.
 O.D. 152.1 mm, I.D. 115.3 mm, W. 24.8 mm
Grommet: Cargo 232634



133934

Replacing 1989705, 10468714
Servicing CS 144, 21SI, 22SI
 12 V. 145 Amp.
 O.D. 144.2 mm, I.D. 107.6 mm, W. 28.2 mm



131864

Replacing 1921465
Servicing 25 SI, 26 SI
 24/32 V. 50 Amp.
 O.D. 158.2 mm, I.D. 115.8 mm, W. 25.3 mm
Grommet: Cargo 232685



133927 Reman.

Replacing 10495208, 10497320
Servicing CS 121
 12 V. 61/74 Amp.
 O.D. 121.6 mm, I.D. 88.8 mm, W. 20.3 mm



135145 Reman.

Replacing 1894594
Servicing 10 SI
 12 V. 18/42 Amp.
 24 V. 40 Amp.
 O.D. 140 mm, I.D. 104.3 mm, W. 19.7 mm



131865 Reman.

Replacing 1891195
Servicing 27 SI
 24 V. 30 Amp.
 O.D. 166.7 mm, I.D. 116.9 mm, W. 21.2 mm



133933

Replacing 10495643, 10495350,
Servicing CS 130
 12 V. 105 Amp.
 O.D. 129.8 mm, I.D. 96.2 mm, W. 21.3 mm



137052

Replacing 10475742, 10476400
Servicing CS130D
 12 V. 100/105 Amp.
 O.D. 129.9 mm, I.D. 96.5 mm, W. 25.3 mm

Replacing DELCO US



232795

Replacing 1975303, -987
Servicing 15SI: 10479823, -825, -833, 1100183, -187, -194, -223, -282, -283, -286, -295, 1101037, -038, -039, -040
 12 V. 70-85 Amp.
 O.D. 149.3 mm, I.D. 107.8 mm, W. 28.2 mm



232799

Replacing 10471056
Servicing 21SI, 22SI: 1117838, -899, -916, -917, -919, -920, -921, -922, -924, -926, -933, -934, -936, -945, -948, -952
 12 V. 145-160 Amp.
 O.D. 144.4 mm, I.D. 107.9 mm, W. 28.2 mm



232802

Replacing 10469997, 10476626
Servicing CS121: 10479949
 12 V. 80 Amp.
 O.D. 122 mm, I.D. 89 mm, W. 20.2 mm



232796

Replacing 1892941
Servicing 27SI/100/200/205: 1100091, -096, -215, -216, 1101020, -050, -059, -091, -109, -178, -287, 1105345, -472
 12 V. 100 Amp.
 O.D. 166.6 mm, I.D. 115.9 mm, W. 20.8 mm



232800

Replacing 10499385
Servicing 25SI, 26SI: 1117264, -265, -266, -268, -269, -270, -271, -272, -276
 12 V. 85 Amp.
 O.D. 157.7 mm, I.D. 115.3 mm, W. 25.4 mm
Grommet: Cargo 232685



232804

Replacing 10470439
Servicing CS144: 10479817, -821, -891, -895, 10480008, -018, -019, -023, -026, -048, -051, -077, -111, -120, -138, -139
 12 V. 145 Amp.
 O.D. 144.3 mm, I.D. 108 mm, W. 28.1 mm



232798

Replacing 1876804
Servicing 30SI: 10459004, -009, -010, 1117067, -068, -481, -482, -483, -484
 12 V. 90 Amp.
 O.D. 158 mm, I.D. 116.2 mm, W. 25.3 mm
Grommet: Cargo 232634



232801

Replacing 10497825
Servicing 30SI: 10459008, 1117801, -802, -807, -809, -811, -812, -813, -816
 12 V. 105 Amp.
 O.D. 157.8 mm, I.D. 115.7 mm, W. 25.5 mm
Grommet: Cargo 232634



232805

Replacing 10470688, -875
Servicing 21SI, 22SI: 1117897, -900, -915, -944, 19010108, -111, -182
 24 V. 50-70 Amp.
 O.D. 144.2 mm, I.D. 107.8 mm, W. 28.6 mm

Replacing DELCO US



232806

Replacing 10491242
Servicing 33SI, 34SI: 19011152, -155, -156, -159, -161, -163, -167, -170, -171, -172, -173, -177, -179, -182, -183, -186
 12 V. 135 Amp.
 O.D. 158.2 mm, I.D. 115.8 mm, W. 24.5 mm



233236

Servicing CS121D: 21023969, 21024727
 Saturn
 12 V. 90 Amp.
 O.D. 122.3 mm, I.D. 88.7 mm, W. 22.8 mm



234342

Servicing AD237 series
 12 V. 125 Amp
 O.D. 144.2 mm, I.D. 108 mm, W. 29 mm



232807

Servicing AD230, CS130D: 10480184, -207, -229, -241, -271, -292, -299, -308, -317, -318, -320, -326, -330, -331, -342, -343, -352, -388, -411, 15768829
 12 V. 105 Amp.
 O.D. 129.9 mm, I.D. 96 mm, W. 27.5 mm



233665

Replacing 15750871
Servicing AD244 series
 12 V. 130 Amp.
 O.D. 144.2 mm, I.D. 107 mm, W. 31.5 mm
Used w/ Rotor: Cargo 234341



234343

Replacing 10467261, 10467991
Servicing 21SI, 22SI series
 12 V. 100 Amp
 O.D. 144.1 mm, I.D. 108 mm, W. 28 mm



233114

Servicing 30SI, 34SI: 19011150, -157
 12 V. 110 Amp.
 O.D. 157.9 mm, I.D. 115.7 mm, W. 25.5 mm



234340

Servicing AD244 series
 12 V. 130 Amp
 O.D. 144.3 mm, I.D. 108 mm, W. 27.5 mm
Used w/ Rotor: Cargo 234339

Replacing DELCO US

Brackets D.E.

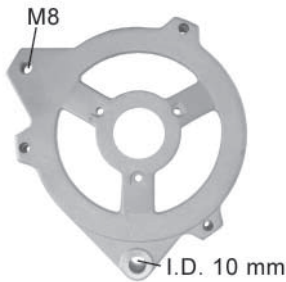

137130

Replacing 10468200, 10495358
Servicing CS130, 1101110, -111, -253, -254, -255, -293, -317, -318, -500, -521, -582, -599, -600, -616, -617, -620, -628
Bearing: Cargo 140087



138696

Replacing 800135, 1959917, 1987105
Servicing 10 DN, 10 SI
Bearing: Cargo 140087

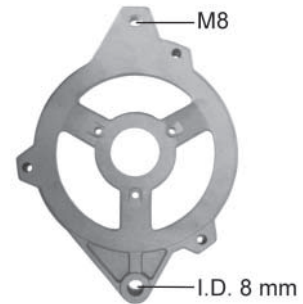

139284

Replacing 1989631, 10468201
Servicing CS130, 1101125, -126, -137, -138, -141, -150, -151, -184, -464, -465, -571, -619, -621, -630, -634, -635, -636
Bearing: Cargo 140087

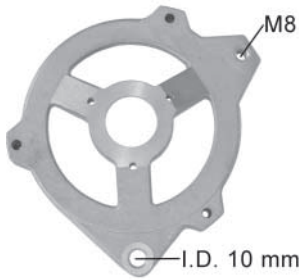

137519

Replacing 10473402, -937
Servicing CS130, 1101135, -136, -139, -140, -142, -143, -148, -149, -154, -160, -162, -227, -231, -246, -259, -277, -278
Bearing: Cargo 140087

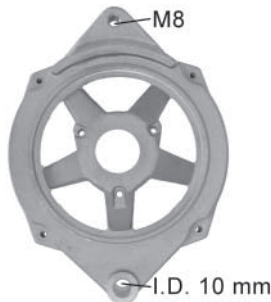

138697

Replacing 1984464, 1987051, 1987054
Servicing 12 SI
Bearing: Cargo 140087

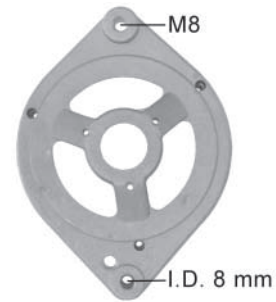

139873

Servicing CS 121: 1101563, -564
Bearing: Cargo 140087

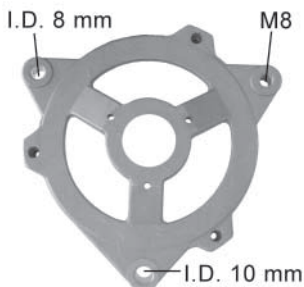

137521

Replacing 10496336
Servicing CS130, 1101191, -461, -605, 1105701, 10479963
Bearing: Cargo 140093

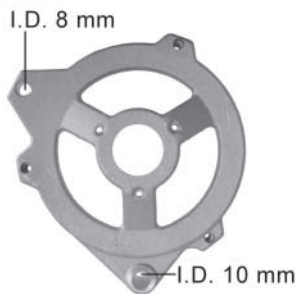

139254

Replacing 10468477, 10498213
Servicing CS130, 1101167, -170
 Jeep
Bearing: Cargo 140087



139874

Servicing CS121: 1101291, -320, -321, -483, -565, 1102615
Bearing: Cargo 140087

Replacing DELCO US

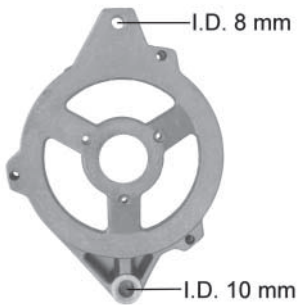

230916

Replacing 10496671, -672
Servicing CS130: 1101158, -179, -181, -186, -229, -264, -272, -273, -275, -292, -601, -678
Bearing: Cargo 140087

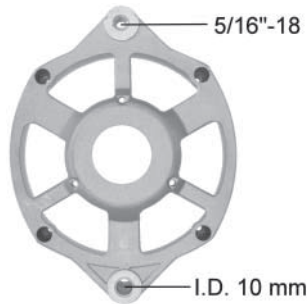

230919

Replacing 1970515, 1977801
Servicing 10SI: 1100059, -063, -064, -065, -068, -074, 1102396, -398, -907, -933, -934, -935, -942, 1103107, -189, -191, 1105075, -077, -435, -436
Bearing: Cargo 140279

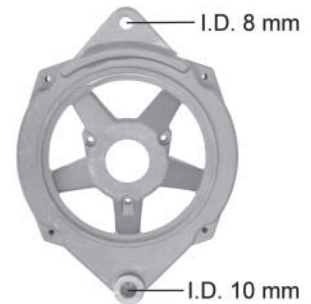

230922

Replacing 1984537, 1986206, 1987997
Servicing 12SI: 1100165, -198, -199, -280, -281, -294, -297, 1101303, -305, 1105025, -027, -028, -041, -042, -493
Bearing: Cargo 140087

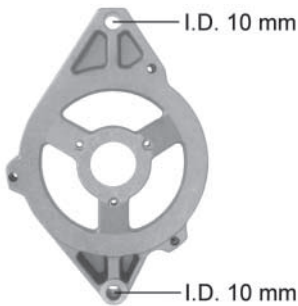

230917

Replacing 10499700
Servicing CS130: 1101310, -577, -649, -650, 1102607, 10479962, 10480027, -40
Bearing: Cargo 140087

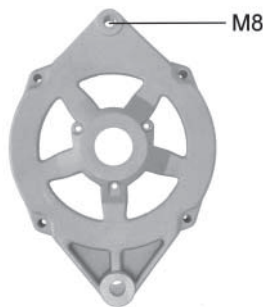

230920

Replacing 1976092
Servicing 10SI: 1100138, 1103080, -081, 1105505
Bearing: Cargo 140087

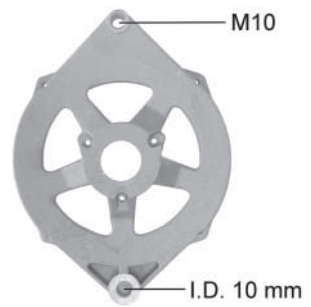

230923

Replacing 1975331, 198569, 1986590
Servicing 15SI, 17SI: 1100183, -184, -187, -192, -219, -223, -224, -271, -278, -286, -293, -295, -296, 1101037, -038
Bearing: Cargo 140087

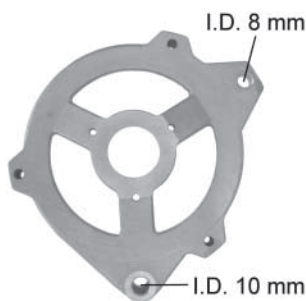

230918

Replacing 10499095
Servicing CS130: 1101101, -107, -466, -467, -606, 10480037
Bearing: Cargo 140087

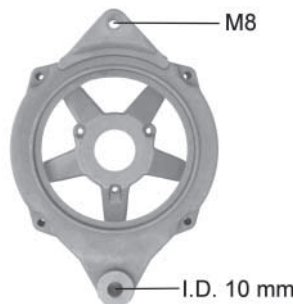

230921

Replacing 1985497
Servicing 12SI: 1100109, -111, -113, -115, -119, -120, -121, -122, -124, -125, -127, -129, -154, -169, -173, -178, -220
 Extended pivot ear
Bearing: Cargo 140087

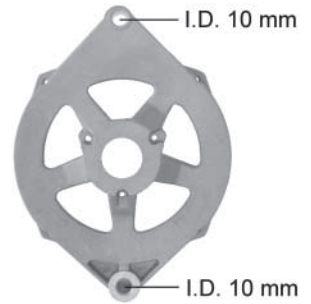

230924

Replacing 1984426
Servicing 15SI, 17SI: 1100282, -283, -284, -285, 1101225, 1105450, -585, -613, -696, 10479862, -868, -916
Bearing: Cargo 140087

Replacing DELCO US

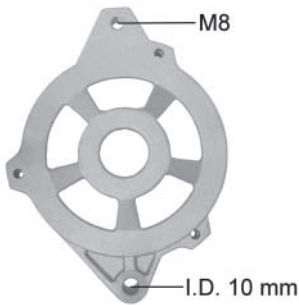

230925

Replacing 10476367
Servicing CS130: 1101125, -126, -137, -138, -141, 10480083, -085, -088, -089, -090, -091, -092
Bearing: Cargo 140093

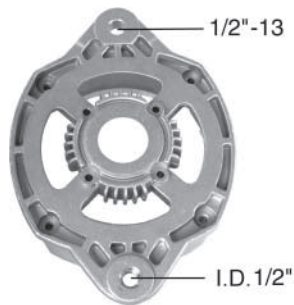

230928

Replacing 1852726, 1968882
Servicing 25SI, 26SI, 30SI: 1117067, -068, -069, -155, -225, -226, -227, -228, -229, -231, -232, -233, -234, -235, -236
Bearing: Cargo 140279

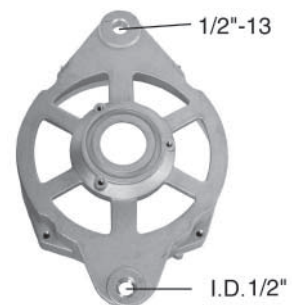

230931

Replacing 1852038, 1985700
Servicing 27SI-200: 1100072, -073, -075, -076, -077, -080, -081, -082, -083, -086, -087, -088, -091, -094, -095, -096, -177
Bearing: Cargo 140279



230926

Replacing 1894483
Servicing 20SI: 1117611, -612, -616, -618, -619, -621, -622, -623, -625, -640, -641, -642, -643, -644, -645, -647, -655
Bearing: Cargo 140279

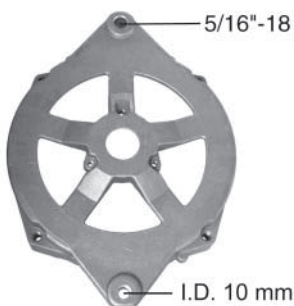

230929

Replacing 801806
Servicing 27SI-100: 1101015, -016, -018, -019, -020, -022, -023, -024, -025, -026, -027, -028, -029, -030, -031, -033, -034
Bearing: Cargo 140087

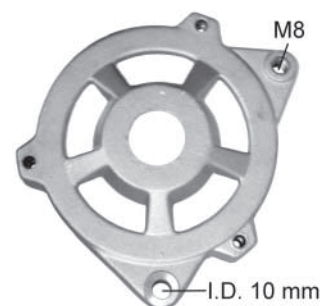

230932

Replacing 10476292
Servicing CS130: 1101139, -140, -142, -143, -148, -149, 10480105, -134, -136, -137
Bearing: Cargo 140093

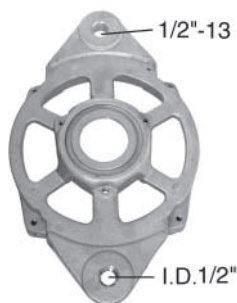

230927

Replacing 10467267
Servicing 21SI: 1117838, -839, -880, -885, -886, -887, -890, -891, -892, -894, -895, -896, -897, -898, -899, -900, -903
Bearing: Cargo 140279

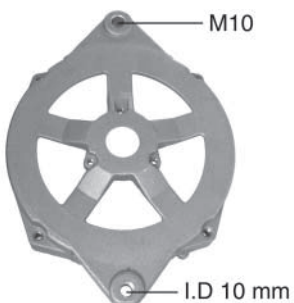

230930

Replacing 1976049
Servicing 27SI-100: 1101046, -047, -049, -050, -058, -059, -060, -061, -062, -064, -073, -090, -091, -109, -178, 1105345
Bearing: Cargo 140087

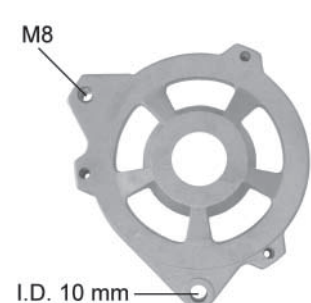

230933

Replacing 10475376, 10476236
Servicing CS130: 1101110, -111, 10480069, -082, -084, -086, -087, -094, -099, -104
Bearing: Cargo 140093

Replacing DELCO US

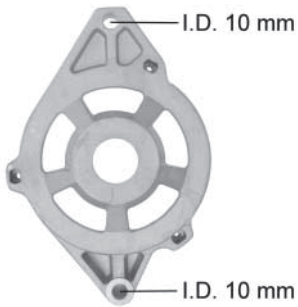

230934

Replacing 10473705, -707, 10476412
Servicing CS130: 10479954, 10480098, -127
Bearing: Cargo 140093

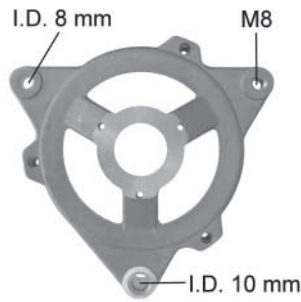

232238

Replacing 10479260, -261
Servicing CS121: 1102614, 1105697, 10479815
Bearing: Cargo 140087

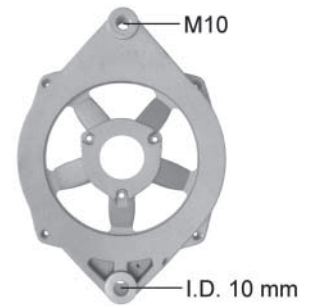

232241

Replacing 1989709, D3450
Servicing CS144: 1101133, -212, -213, -214, -239, -270, -294, -295, -296, -329, -330, -350, -482, -486, -487, -490, -491, -493, -518, -519, -574, -591, -805
Bearing: Cargo 140087

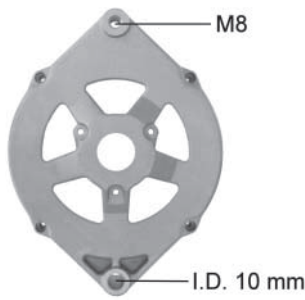

232236

Replacing 1974937, 1985642, 1987104
Servicing 10SI: 1110130, -131, -132, -133, -140, -141, -142, -143, -145, -146, -148, -149, -150, -151, -152, -238, -256, -267, 1102941, 1103043, -044, -045
Bearing: Cargo 140087

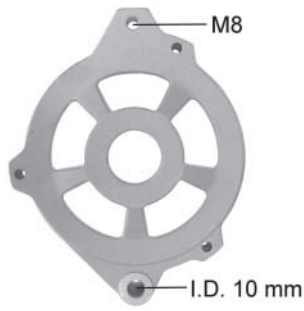

232239

Replacing 10495814, -816, D3456
Servicing CS130: 1101123, -124, -144, -145, -190, -475, -608, 1105669, -670, 10479898, -937, -938
Bearing: Cargo 140093

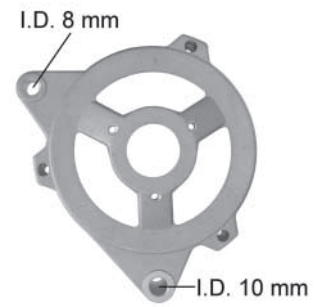

232242

Replacing 10497722, -724
Servicing CS121: 1101168, 10463050
Bearing: Cargo 140087

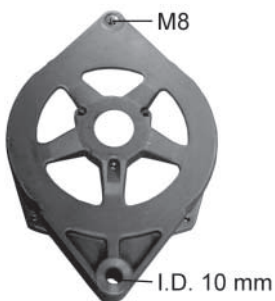

232237

Replacing 1979011, 1986591, D3441
Servicing 15SI: 1101076, -077, -079, -092, -096, -438, -441, -446, -447, 1105329, -337, -338, -340, -341
Bearing: Cargo 140087

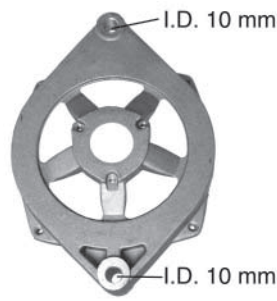

232240

Replacing 1989601, 10470800, D3449
Servicing CS144: 1101182, -183, -237, -238, -250, -274, -316, -325, -326, -331, -349, -454, -566, -567, -573, -597, -604, -849, 1105615, -616, -684, -685
Bearing: Cargo 140087

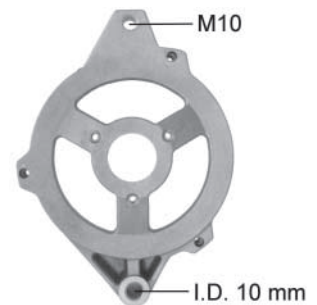

232243

Replacing 10467239, -240
Servicing CS130: 1101478, -480
Bearing: Cargo 140087

Replacing DELCO US

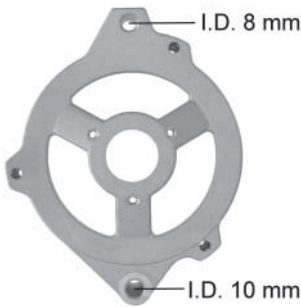

232244

Replacing 10468448, 10473393
Servicing CS130: 1101173, -271, -642, 10480035
 Bearing: Cargo 140087

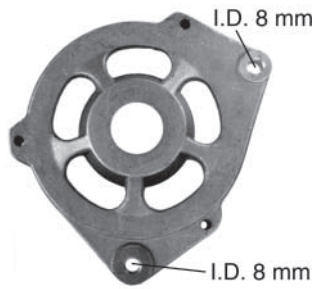

232247

Servicing CS130: 21021447, 21022772, 21023516, -702
 Saturn 1992-97
 Bearing: Cargo 140087

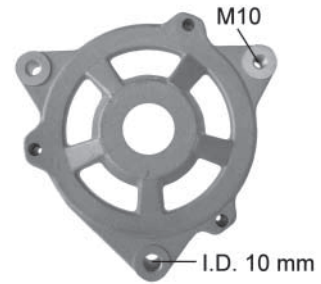

232250

Replacing 10476370, -371
Servicing CS130: 10480093
 Bearing: Cargo 140087

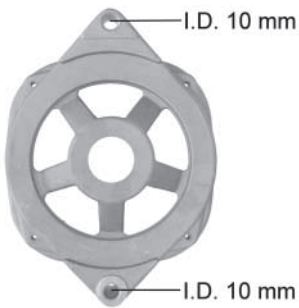

232245

Replacing 10471339, D3463
Servicing CS144: 1101590, -844, 1102605, -616, -625, 10479891, -966, 10480010, -011, -018, -022, -023, -026, -033, -034, -111, -120, -171, -201, -203
 Bearing: Cargo 140093

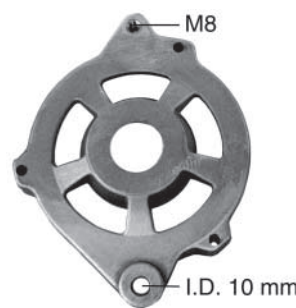

232248

Replacing 10468449, -671, 10469874
Servicing CS130: 1101266, -267, -638, 1102644, 10479969, -976
 Bearing: Cargo 140093

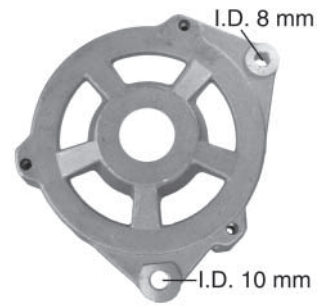

232251

Replacing 10475909, -910
Servicing CS130: 10480025, -172, -181, -265
 Bearing: Cargo 140093

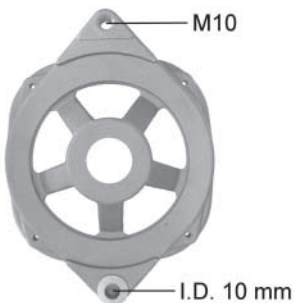

232246

Replacing 10470419, D3465
Servicing CS144: 1101578, -579, -818, -819, -847, -850, 10479817, -852, -995, -996, 10480009, -012, -019, -024, -048, -116, -122, -138, -139, -177, -200, -202
 Bearing: Cargo 140093

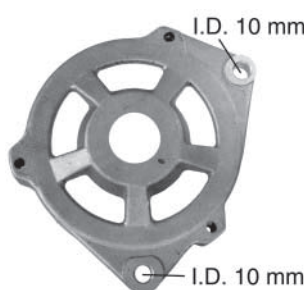

232249

Replacing 10474599, 10477537
Servicing CS130: 1101644, 10480157
 Bearing: Cargo 140093

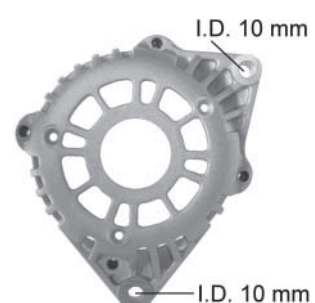

232252

Replacing 10476387
Servicing CS130D: 10480052, -071, -119, -195, -196, -217, -233, -235, -236, -237, -238, -259, -263, -353
 Bearing: Cargo 140093

Replacing DELCO US

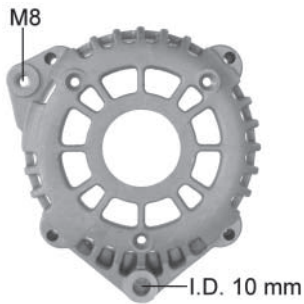

232253

Replacing 10475739

Servicing CS130D: 10479981, -984, 10480017, -072, -187, -188, -189, -190, -252

Bearing: Cargo 140093

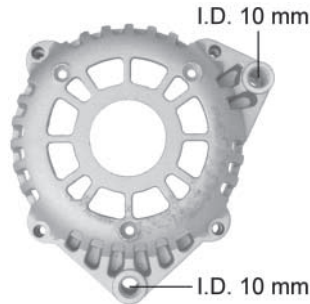

232256

Replacing 10488598, 10492103

Servicing CS130D: 10480167, -168, -170, -198, -251, -254

Bearing: Cargo 140093

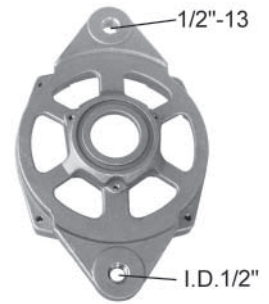

232259

Replacing 10492754

Servicing 22SI: 19020300, -302, -303, -304, -305, -306, -307, -308, -309, -310, -312, -314, -346, -355, -356, -357, -358, -359, -360, -361, -362, -363, -364, -365

Bearing: Cargo 140279

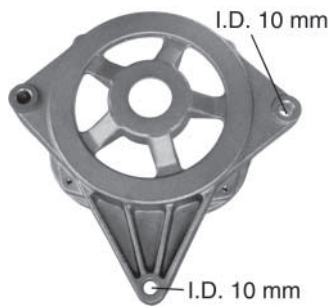

232254

Replacing 10487578

Servicing CS144: 10480135, -186, -204, -205, -227, -278, -279, -363

Bearing: Cargo 140093

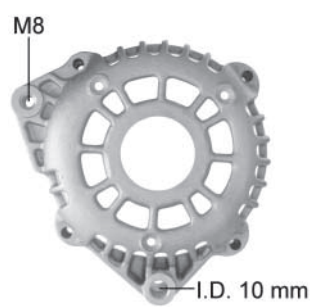

232257

Servicing CS130D: 10480076, -078, -289, -321, -361

Bearing: Cargo 140093

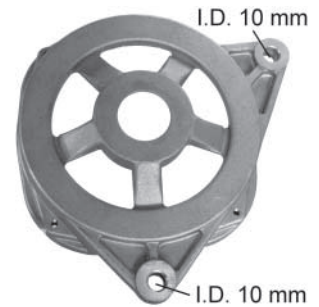

232260

Replacing 10489792

Servicing CS144: 10480077, -211

Bearing: Cargo 140093

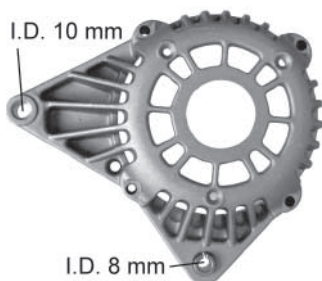

232255

Replacing 10477835

Servicing CS130D: 10480182, -218, -240, -260, -262, -264, -301, -307, -351, -354, -378

Bearing: Cargo 140093

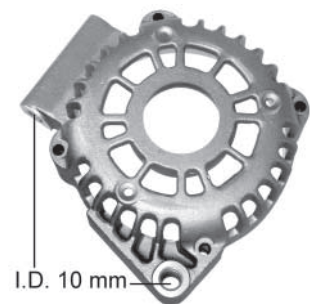

232258

Servicing CS130D: 10480079, -322

Bearing: Cargo 140093

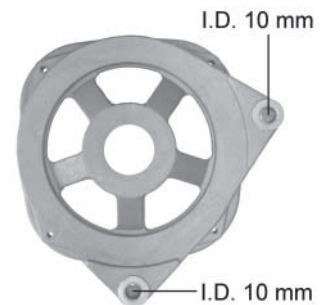

232261

Replacing 10477422

Servicing CS144: 10480130, -133, -156, -192, -206, -255, -267

Bearing: Cargo 140093

Replacing DELCO US

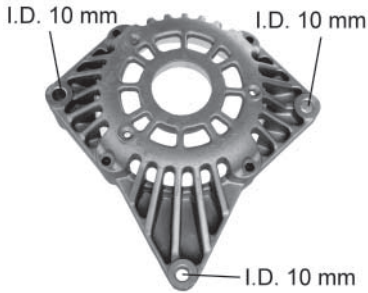

232262

Servicing CS130D: 10480191, -250
Bearing: Cargo 140093

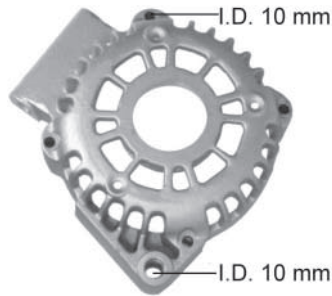

232271

Servicing CS130D: 10480184, -207, -320
Bearing: Cargo 140093

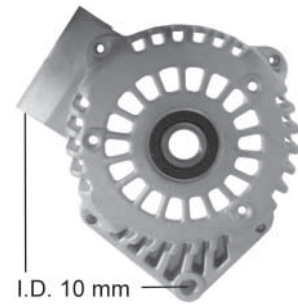

233103

Servicing AD230: 10480241
W/ bearing

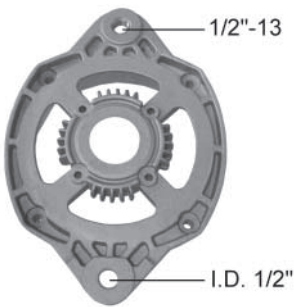

232269

Replacing 10491185
Servicing 33SI, 34SI: 19011150, -151, -152, -153, -154, -155, -156, -157, -158, -159, -160, -161, -162, -163, -165, -166
Bearing: Cargo 140279
Thru bolt: 1/4"



232412

Replacing 1976859, 1977817
Servicing 10SI: 1100092, 1102365, -366, 1103132, -134, -190, 1105063, -071, -076, -453, -454, -482
 Farm and Industrial equipment
Needle bearing: Cargo 140120

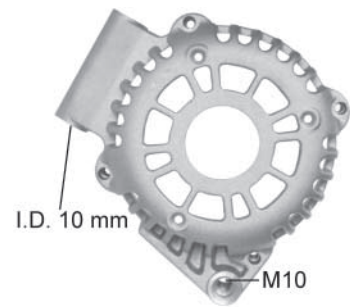

233104

Servicing CS130D: 10480332, -336
Bearing: Cargo 140093

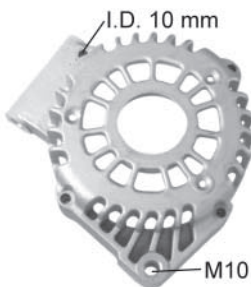

232270

Servicing CS130D: 10480299, -317, -318
Bearing: Cargo 140093

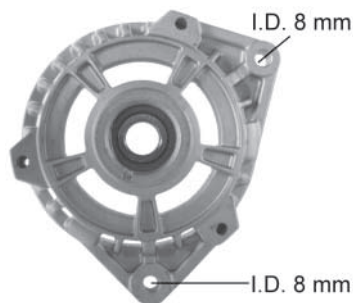

233102

Servicing CS121D: 21023969, 21024727
 Saturn
W/ bearing



234686

Replacing 10477149
Servicing CS130D: 10463605, 10480074
Bearing: Cargo 140093

Replacing DELCO US

Brackets S.R.E.

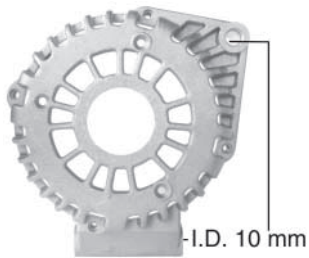

234687

Replacing 10483770
Servicing CS130D: 10464406, -408, -440, -441, 10480244, -368, -414, -428
Bearing: Cargo 140093

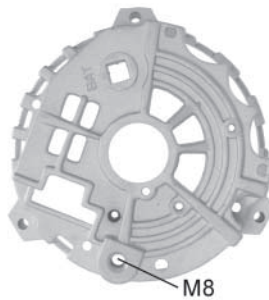

137131

Replacing 10469357, 10474266
Servicing CS130, 1101461, -464, -465, -466, -467, -475, -478, -480, -521, -571, -577, -582, -583, -593, -595, -596, -599, -600, -601, -603, -605, -606, -608, -612, -616, -617, -618, -619, -620, -621, -628

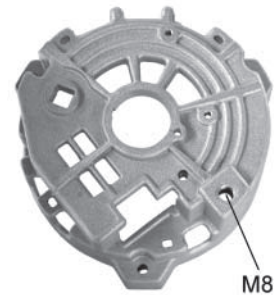

139870

Servicing CS 121: 10479815, 10480067

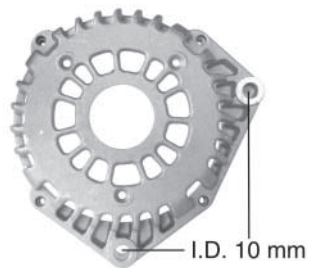

234689

Replacing 10484939
Servicing AD244: 10464405, 10480234, -390, 15768830
Bearing: Cargo 140093

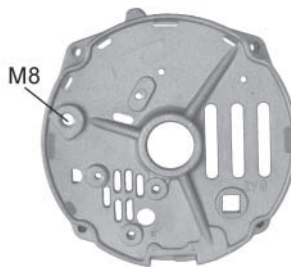

138698

Replacing 1975718
Servicing 10 SI - Type 116, -136

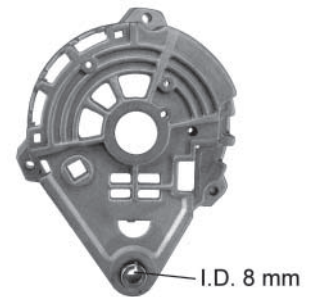

139871

Servicing CS 121: 10479805

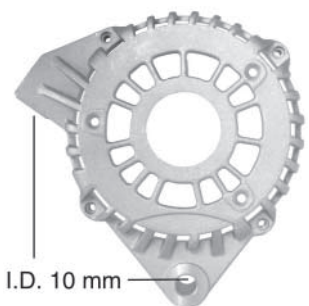

234690

Replacing 10494479
Servicing AD237: 10464395, -442, -469, 10480303, -327, -341
Bearing: Cargo 140093

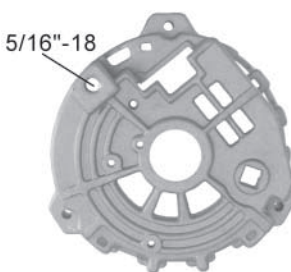

139869

Servicing CS 121: 1101168, -171, -172, -175, -176, -291, 1102614, -615, 1105697



230875

Replacing 1851201, 1852101, 1971526
Servicing 10SI: 1100486, -487, -490, -491, -492, -493, -494, -497, 1102839, -840, -841, -842, -843, -844, -845, -846, -847, -848, -849, -850, -851, -853, -854
Needle bearing: Cargo 140120

Replacing DELCO US

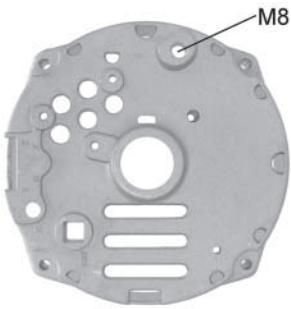

230877

Replacing 1974939

Servicing 10SI: 1100109, -110, -111, -113, -115, -119, -120, -121, -122, -124, -125, -127, -129, -130, -131, -132, -133, -138, -139, -140, -141, -142, -143, -145
Needle bearing: Cargo 140120

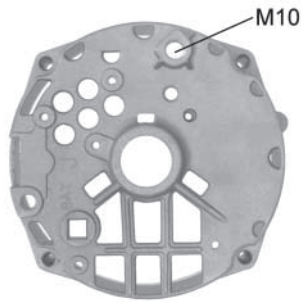

230880

Replacing 1985500

Servicing 12SI: 1100244, -258, 1105354, -355, -439, -440
Needle bearing: Cargo 140120

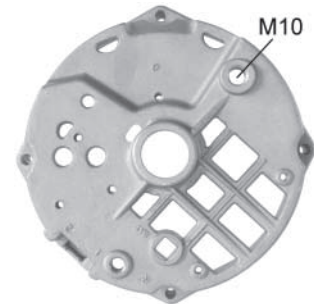

230937

Replacing 1985671

Servicing 17SI: 1101112, -113, -115, -164, -224, -225, -236, -297, -306, -309, 1105416, -450, -451, -479, -481, -497, -509, -513, -515, -549, -553, -570, -587
Needle bearing: Cargo 140120



230878

Replacing 1852951

Servicing 10SI: 1100092, -499, 1102871, 1103134, -190, 1105063, -071, -076, -453, -454, -481
 Farm and Industrial equipment
Needle bearing: Cargo 140120

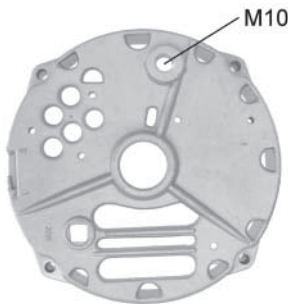

230935

Replacing 1979719

Servicing 15SI-116: 1101194, -205, -439, -440, 1102551, 1105418, -536, -538, -539, -540, -560, -579, -609, 10479924, -925, -926, -927, -929, -930
Needle bearing: Cargo 140241

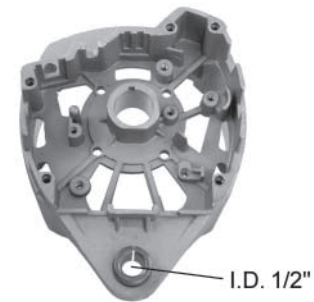

230938

Replacing 1894465

Servicing 20SI: 1117611, -612, -616, -618, -619, -640, -641, -642, -643, -644, -645, -647, -655
Needle bearing: Cargo 140136

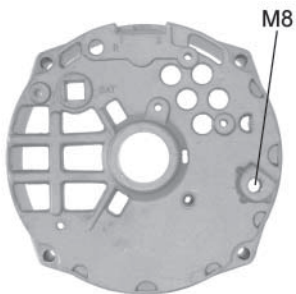

230879

Replacing 1984460, 1987056, 1987073

Servicing 12SI: 1100200, -203, -204, -206, -207, -208, -209, -217, -225, -226, -227, -228, -229, -230, -231, -232, -233, -234, -235, -236, -237, -239, -240, -241
Needle bearing: Cargo 140120

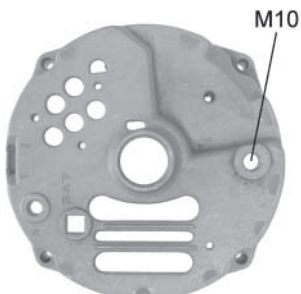

230936

Replacing 1979773, 1975310

Servicing 15SI: 1100183, -184, -187, -190, -192, -193, -194, -195, -219, -223, -224, -271, -282, -283, -284, -285, -286, -293, -295, -296, 1101037, -038, -039
Needle bearing: Cargo 140241

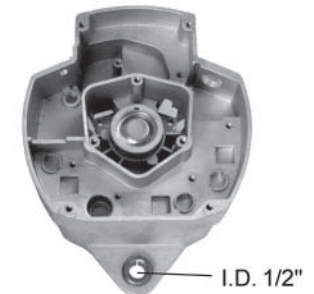

230939

Replacing 1892959, -960

Servicing 25SI: 1117069, -155, -225, -226, -227, -228, -229, -231, -232, -233
Needle bearing: Cargo 140228
Inner race: Cargo 140229
Negative Diodes: Cargo 133194 x 3

Replacing DELCO US

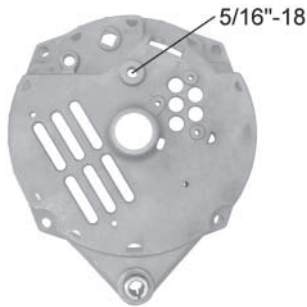

230940

Replacing 801813

Servicing 27SI-100: 1101015, -016, -018, -019, -020, -022, -023, -024, -025, -026, -027, -028, -029, -030, -031, -033, -034
Needle bearing: Cargo 140120

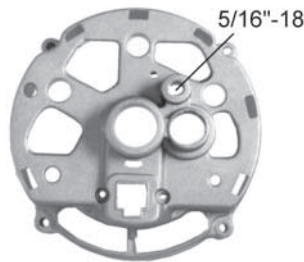

232272

Replacing 1852934

Servicing 10DN: 1100059, -063, -068, -074, -553, -557, -558, -566, -567, -568, -569, -570, -571, -572, -590, -591, -655, -656, -657, -658, -659, -660, -661, -662
Needle bearing: Cargo 140120

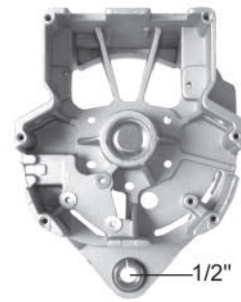

232275

Replacing 1876762

Servicing 30SI: 1113231, -233
Needle bearing: Cargo 140228

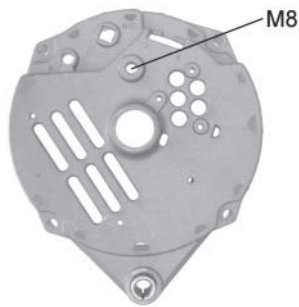

230941

Replacing 1976141

Servicing 27SI-100: 1101046, -047, -049, -050, -058, -059, -060, -061, -062, -063, -064, -073, -090, -091, -109, -178
Needle bearing: Cargo 140120

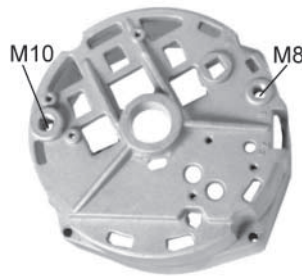

232273

Replacing 1988991, D3336

Servicing 17SI: 1101215, -252, -258, -290, 1105585, -613, -643, -658, -680, -683, -690, 10479864, -868, -870, -915
Needle bearing: Cargo 140120

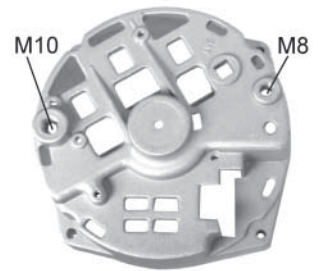

232276

Replacing 1989706, 10468851

Servicing CS144: 1101133, -182, -183, -212, -213, -214, -237, -238, -239, -250, -263, -270, -274, -294, -295, -296, -316, -325, -326, -329, -330, -349, -454, -482
Bearing: Cargo 141002

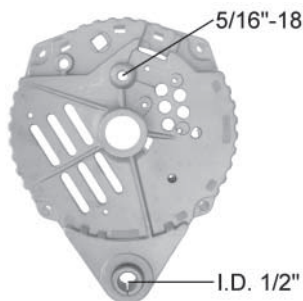

230942

Replacing 1852630, 1988072

Servicing 27SI-200: 1100072, -073, -075, -076, -077, -080, -081, -082, -083, -086, -087, -088, -091, -177, -188, -189, -211, -212, -213, -214, -215, -274, 1101102
Needle bearing: Cargo 140136

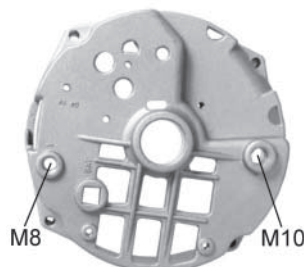

232274

Replacing 1987711

Servicing 17SI: 1100278, 1105491, 1107585, 10479858
Needle bearing: Cargo 140120

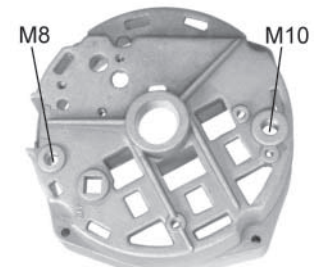

232277

Replacing 1989517, D3337

Servicing 17SI: 1101215, -252, -258, -290, 1105585, -613, -643, -658, -680, -683, -690, 10479864, -868, -870
Needle bearing: Cargo 140120

Replacing DELCO US

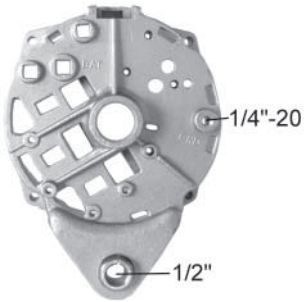

232278

Replacing 10467269, 10475434
Servicing 21SI: 1117838, -839, -880, -885, -886, -887, -890, -891, -892, -894, -895, -896, -897, -898, -899, -900, -903, -904, -905, -911, -912, -913, -914, -915
Needle bearing: Cargo 140772

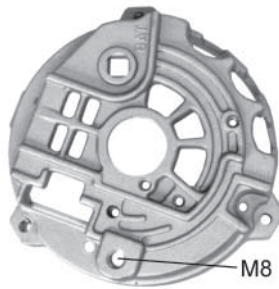

232281

Replacing 10474091
Servicing CS130: 10479998, 10480105
Used w/ Cargo 133038 or 231447
Tolerance ring
Used w/ Cargo 141271 or 140784 Bearing

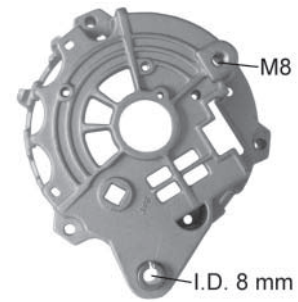

232284

Replacing 10477626
Servicing CS130: 21021447, 21022516, -772, 21023702, -724
 Saturn
Bearing: Cargo 140271 or 140784

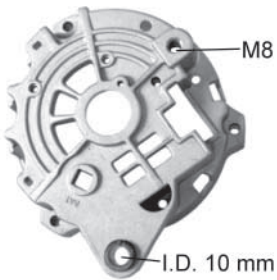

232279

Replacing 10474269, 10498837
Servicing CS130: 1101266, -267, -638, -644, 1102644, 10479969, -976, 10480157
Bearing: Cargo 140271 or 140784

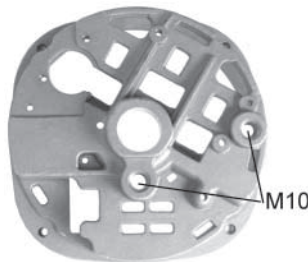

232282

Replacing 10474366
Servicing CS144: 1101850, 10479995, 10480019, -177, -282, -296, -297, -310, -311
Needle bearing: Cargo 140773

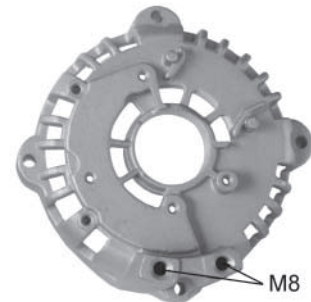

232285

Servicing CS130D: 10479981, -984, 10480017, -043, -072, -074, -076, -078, -187, -188, -189, -190, -191, -250, -252, -289, -321, -361
Bearing: Cargo 140084

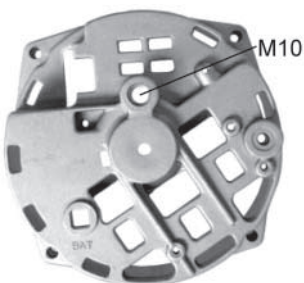

232280

Replacing 10467412
Servicing CS144: 1101331, -490, -519, 10479844
Bearing: Cargo 141002

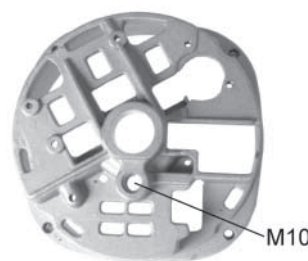

232283

Replacing 10474212
Servicing CS144: 1102625, 10479966, 10480009, -010, -012, -034, -116
Needle bearing: Cargo 140773

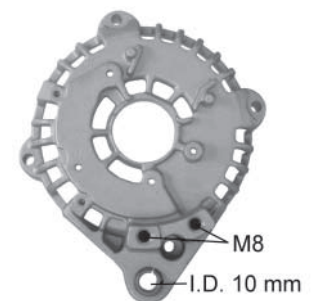

232286

Servicing CS130D: 10480052, -071, -119, -195, -196, -217, -233, -235, -236, -237, -238, -259, -263, -353
Bearing: Cargo 140084

Replacing DELCO US

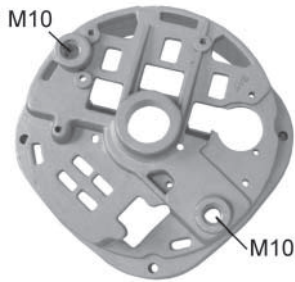

232287

Replacing 10476416, 10478014
Servicing CS144: 10480111, -135, -139, -156, -171, -186, -192, -200, -202, -203, -206, -255, -267, -269
Needle bearing: Cargo 140773

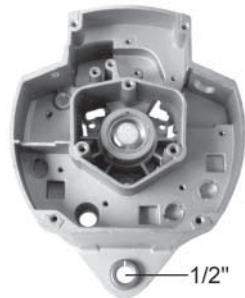

232290

Replacing 10457112, 10472647
Servicing 26SI: 19010000, -001, -002, -003, -004, -005, -006, -007, -008, -009, -010, -011, -012, -013, -014, -018, -019, -020
Needle bearing: Cargo 140228

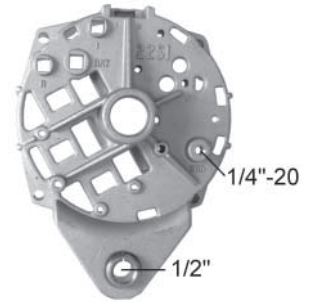

232293

Replacing 10492747
Servicing 22SI: 19020302, -303, -304, -305, -306, -307, -308, -309, -310, -312, -346, -354, -358, -359, -360, -362, -363
 1/4" thru bolt holes
Needle bearing: Cargo 140136

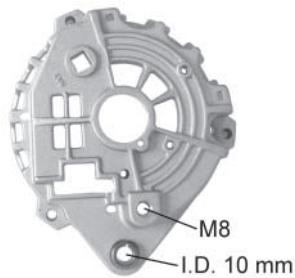

232288

Replacing 10475912
Servicing CS130: 10480025, -172, -181, -265
Bearing: Cargo 140271



232291

Servicing CS130D: 10480167, -168, -170, -198, -251, -254
Bearing: Cargo 140087

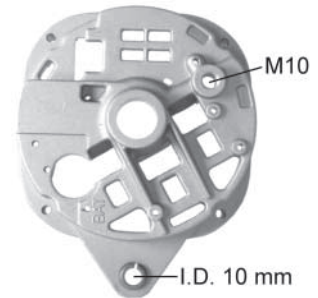

232296

Replacing 10489795
Servicing CS144: 10480077, -211
Needle bearing: Cargo 140773

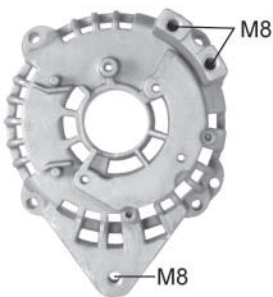

232289

Servicing CS130D: 10480182, -218, -240, -260, -262, -264, -301, -307, -351, -354, -378
Bearing: Cargo 140087

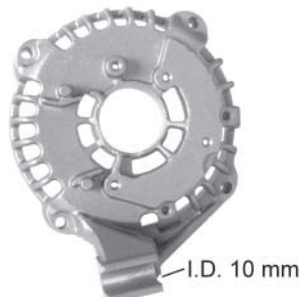

232292

Servicing CS130D: 10480079, -322, -332, -336
Bearing: Cargo 140087

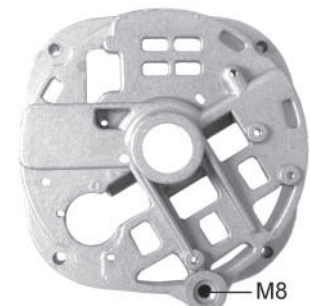

232297

Replacing 10489379
Servicing CS144: 10480204, -205, -227, -278, -279, -363
Needle bearing: Cargo 140773

Replacing DELCO US

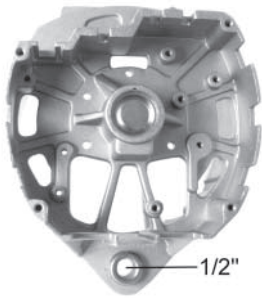

232298

Replacing 10491175
Servicing 33SI: 19011150, -151, -152, -153, -154, -155, -156, -158, -159, -160, -161, -162, -163, -171, -173, -174, -175, -180, -182, -192
Needle bearing: Cargo 140228

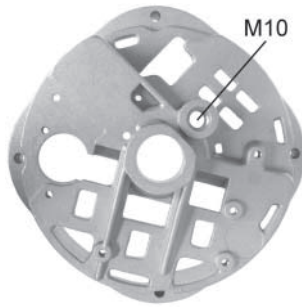

232406

Replacing 10474203
Servicing CS144: 1101818, -819, 10479891, 10480008, -011, -018, -022, -023, -024, -026, -033, -048, -201
Needle bearing: Cargo 140773



234685

Replacing 10494725
Servicing AD230: 10480229, -271, -326, -388, 15768829, 15769252
Bearing: Cargo 140084



232299

Replacing 10491342
Servicing 34SI: 19011157, -167, -168, -169, -170, -172, -179, -186, -191
Needle bearing: Cargo 140228

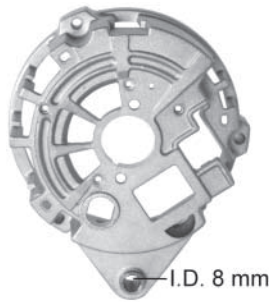

233109

Servicing CS121D: 21023969, 21024727
 Saturn



234691

Replacing 10494480
Servicing AD237: 10464442, -495, 10480303, -341
Bearing: Cargo 140084



232300

Servicing CS130D: 10480184, -207, -299
Bearing: Cargo 140087

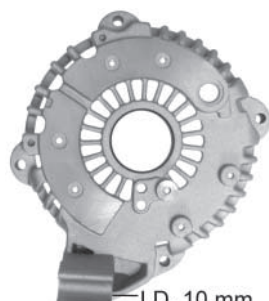

233110

Servicing AD230: 10480241



234692

Replacing 10482942
Servicing AD244: 10464405, -443, -456, -460, -461, -466, -467, -489, 10480234, -270, -390, 15056099, -100, -830, 15768830, 15769253, -254
Bearing: Cargo 140084

Replacing DELCO US

Bracket Parts



131924 Std pkg 5
Servicing CS 130 series
 Cover, S.R.E Bracket



139875 Std pkg 5
Servicing CS 121
 Cover, S.R.E. bearing



232635 Std pkg 5
Servicing AD230, -237, -244
 O.D. 37 mm, I.D. 35 mm, W. 12.7 mm
 Bearing cap



133929 A
Servicing CS 121
 Cover, S.R.E. Bracket



232754
Servicing AD230, -237, -244
 O.D. 32 mm, I.D. 14.9 mm
 Cover, S.R.E. bearing



232737
Replacing 1892765, 1968990
Servicing 20SI, 21SI, 22SI, 25SI, 26SI,
 27SI/200, 29SI, 30SI, 33SI, 34SI
 12.7 x 22.23 x 31.27 mm
 (1/2" x 7/8" x 13/16")
 Mounting bushing, S.R.E.



231361
Servicing CS121D: 21023969, 21024727
 Cover, S.R.E. Bracket



232739 Std pkg 5
Servicing 10SI
 L. 48.5 mm (1 15/16")
 Reduces 10 mm mounting hole to 3/8"
 Sleeve for Bracket D.E.



232738
Replacing 1976143
Servicing 27SI/100
 10 x 16.5 x 25.5 mm
 Mounting bushing, S.R.E.



232727 Std pkg 5
Replacing 10470444
Servicing CS130: 21021447, 21022772,
 21023516, -702, -724
 Saturn
 Cover, S.R.E. Bracket



133038 Std pkg 10 A
Replacing 10469356
Servicing CS 121, CS 130
 O.D. 28 mm, I.D. 26 mm, W. 11.3 mm
 Bearing cap



232742
Replacing 10498833
Servicing CS130: 1101266, -267, -638,
 -644, 1102644, 10479969, -976,
 10480025, -157, -172, -181, -265
 10 x 16-22 x 20 mm
 Mounting bushing, S.R.E.

Replacing DELCO US



232744
Replacing 10476635
Servicing CS130
 8 x 14-22 x 20 mm
 Mounting bushing, D.E., S.R.E.



231448 Std pkg 5
Servicing CS144
 Bearing retainer
Used w/ bearings: Cargo 140093



232764 Std pkg 5
Replacing 1961867
Servicing 20SI, 27SI/200, 29SI
 Bearing retainer, D.E. Bracket



232745
Replacing 10476382
Servicing CS130D, CS144
 10 x 16-22 x 21 mm
 Mounting bushing, S.R.E.



232734 Std pkg 5
Replacing 1911263, 1977674, 1988674
Servicing 10DN, 10SI, 12SI, 15SI, 17SI, 27SI, CS144
 Bearing retainer, D.E. Bracket



232765
Replacing 10497221, 1970407
Servicing 25SI, 26SI, 30SI, 33SI, 34SI
 Cast iron
 Bearing retainer, D.E. Bracket

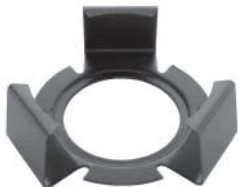

137704
Servicing CS121, CS130
 For bearing 6203 series
 Bearing retainer



232736 Std pkg 5
Servicing CS130
 Bearing retainer for 6303 bearing used
 w/ O.E. Bracket D.E.



232735 Std pkg 5
Replacing 1955664
Servicing 20SI, 27SI, 29SI
 Bearing retainer



137705 Std pkg 5
Servicing CS130D
 Bearing retainer for 6303 series



232763
Replacing 10467271
Servicing 21SI, 22SI
 Bearing retainer, D.E. Bracket



232683
Replacing 1968884
Servicing 25SI, 30SI
 Gasket for bearing retainer

Replacing DELCO US

Also see Oil Seal Survey page 856



138130 A

Replacing 1958509
Servicing 25 SI, 26 SI
 35 x 51 x 8 mm
 Oil seal



231447 Std pkg 10

Replacing 10473712
Servicing CS130
 O.D. 28 mm, I.D. 26 mm, L. 9.5 mm
 Tolerance ring
Used w/ bearings: Cargo 140271, 140784



232049 Std pkg 5

Replacing 10476122
Servicing CS121
 O.D. 28 mm, I.D. 26 mm, L. 35 mm
 Tolerance ring



231449 Std pkg 5

Replacing 10470414
Servicing CS144
 Cover for slip ring



232732

Replacing 10474067
Servicing 21SI: 1117898, -965,
 19010178, -180, -181, -182, -190, -191,
 -192
 Dust cover, D.E. bearing



232753

Replacing 1969070
Servicing 20SI, 27SI/200, 29SI
 Dust cover, D.E. bearing



233409 Std pkg 10

10-24 x 5/8"
 Screw for bearing plate



233410 Std pkg 10

Replacing 1975736
 10-24 x 1/2"
 Screw for bearing plate

Covers



137055

Replacing 10475768
Servicing CS130D: 10479981, -984,
 10480017, -043, -071, -072, -119, -188



232047

Replacing 1985495
Servicing 10SI marine
 Spark arresting cover

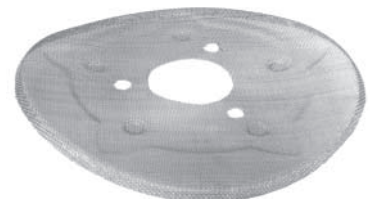

232048

Replacing 1976482
Servicing 10SI marine
 Spark arresting screen
 Set of 3

Replacing DELCO US



232301

Replacing 10476383
Servicing CS130D: 10480052, -196, -233, -235



232304

Replacing 10490877
Servicing CS130D: 10480207, -299, -317, -318, -332, -336



232678

Replacing 1876814
Servicing 30SI
 Cover



232302

Replacing 10488602
Servicing CS130D: 10480079, -167, -168, -170, -198, -251



232305

Servicing CS130D: 10480308, -342, -343



232728

Servicing AD230, AD237, AD244: 10480229, -234, -241, -244, -270, -271, -303, -326, -327, -341, -357, -368, -383, -388, -390, -414, -428, 15768829, 15769252



232303

Replacing 10490891
Servicing CS130D: 10480184, -320



232677

Replacing 1894444
Servicing 20SI
 Cover

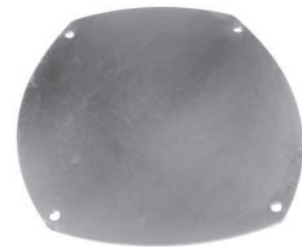

232729

Replacing 1969001
Servicing 25SI, 26SI
 Cover plate

Replacing DELCO US

Regulators

Volt setting 14.5 V.



232733

Replacing 10491181
 Servicing 33SI, 34SI
 Cover plate



130505

Replacing 1119515
 Servicing 10 DN
 12 V. Electronic
 F-S-B+-L



233623

Replacing 1118981, -988
 12 V.

Volt setting 27.5 V.



232679

Replacing 1851153
 Servicing 10SI type 116, -136
 Chaff shield



233252

Replacing 1119518
 24 V.
 Terminals F(B)-ST-+-L/IG



233624

Replacing 1118381, -779, -997, -999
 12 V.

Volt setting 14.2 V.



233622

Replacing 1118266, -306, -791, -983, -985
 12 V.



130509

Replacing 1876388
 Servicing 27 SI, 30 SI
 12 V.

Replacing DELCO US

Volt setting 27.1 V.



130510

Replacing 1116388
Servicing 20 SI - TYPE 200, 29 SI, 30 SI
 24 V.

Volt setting 14.2 V.

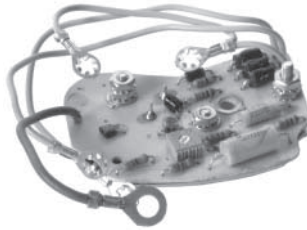

131901

Replacing 1968949
Servicing 25 SI
 12 V.
 Negative ground

Volt setting 14.6 V.

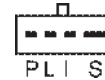

131905 HD

Replacing 1116411
Servicing CS 121, CS 130, CS 144 series
 12 V.
 No. 411 on regulator case
 2.5 sec. LRC
 Soft start

Volt setting 14.7 V.



130668

Replacing 1116380
Servicing 10 SI, 12 SI, 15 SI, 17 SI, 27 SI
 Type 100 - 205 serie
 12 V.

Volt setting 27.5 V.

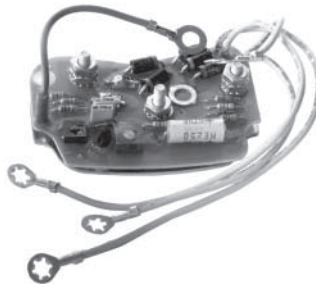

131903

Replacing 1969110
Servicing 25 SI
 24 V.
 Negative ground

Volt setting 14,2 V.



131906

Replacing 1116412
Servicing CS 144 series
 12 V.
 No. 412 on regulator case
 10 sec. LRC
 Soft start

Volt setting 14.8 V.



131900

Replacing 1988988, D674
Servicing 12 SI, 17 SI
 12 V. 7 Amp. field

Volt setting 14.6 V.

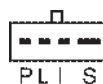

131904

Replacing 1116408
Servicing CS 130, CS 144 series
 12 V.
 No. 408 on regulator case
 2.5 sec. LRC
 Soft start

Volt setting 14.2 V.



133581

Replacing 1116425
Servicing CS 130, CS 144
 12 V.
 2.5 sec. LRC
 Soft start

Replacing DELCO US

Volt setting 14.6 V.



133582

Replacing 1116413
Servicing CS 144
 12 V.
 10 sec. LRC
 Soft start

Volt setting 28.2 V.



134751

Replacing 1116405
Servicing 27 SI, 30 SI
 webbed terminals
 24 V.

Volt setting 14.6 V.



231183

Replacing 19009703
Servicing CS130D: 10480043, -182, -240, -262, -264
 12 V.
 10 Sec. LRC

Volt setting 14.7 V.



133589

Replacing 1116432, 16148399
Servicing CS 121
 12 V.
 L - Terminal drives choke
 Soft start

Volt setting 14.6 V.



135547

Replacing 19009702
Servicing CS130D
 12 V.
 No. 466 on regulator case
 2.5 sec. LRC
 Soft start

Volt setting 14.6 V.



231184

Replacing 19009705
Servicing CS130D: 10480074, -076, -079, -184, -191, -207, -217, -218, -250, -251, -252, -259, -260, -289, -299, -301
 12 V.
 10 Sec. LRC

Volt setting 14.2 V.



134750

Replacing 1116406, 1116407, 1116433
Servicing 10 SI, 29 SI, 30 SI
 webbed terminals
 12 V.

Volt setting 14.2 V.



139637

Replacing 1116433, -435, -442
Servicing 20 SI, 21 SI, 25 SI, 26 SI, 30 SI
 12 V.
 1-Wire system
 W/ webbed terminals

Volt setting 14.2 V.

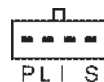

231185

Replacing 19009706
Servicing CS130D: 10480170
 12 V.
 2.5 Sec. LRC

Replacing DELCO US

Volt setting 14.8 V



232074

Replacing TR12-125
Servicing Honda
 12 V.

Volt setting 14.8 V.

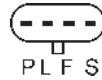

232665

Replacing 10458200, -201
Servicing AD230, AD244: 104582002, 10480234, -326, -327, -341, -388
 12 V.
 2.5 sec. LRC w/ open sense indication

Volt setting 14.2 V.



233204

Replacing 1116438, -439, -441
Servicing 21SI, 22SI: 1117838, -839, -895, -896, -898, -899, -903, -904, -912, -926, -927, -928, -936, -940, -945, 19010118, -145, -147, -168
 12 V.

Volt setting 14.8 V



232413

Replacing 1116446, D602A
Servicing CS144: 10480135, -171
 12 V.
 10 sec. LRC

Volt setting 14.8 V.

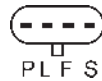
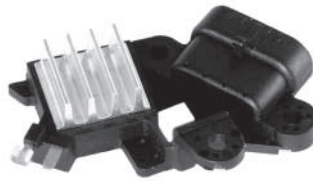

232666

Servicing AD237: 10480368, -428
 12 V.
 10 sec. LRC w/o open sense indication

Volt setting 14.8 V.



233251

Replacing 19009748, -761
Servicing CS130D: 10437987, -988, 10480288, -292, -318, -330, -331, -336, -346, -348, -352, -378, 15760058
 12 V.
 2.5 sec. LRC

Volt setting 14.8 V.

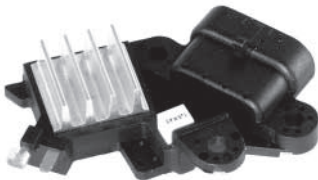

232664

Replacing 10458198
Servicing AD230, AD237: 10480241, -244, -303, -357
 12 V.
 10 sec. LRC w/ open sense indication

Volt setting 14.8 V.



233203

Replacing 1116440
Servicing CS121: 10479805, 10480095, -096
 12 V.
 2.5 sec. LRC

Volt setting 14.8 V.



233737

Replacing 94648534, D-673
 12 V.

Replacing DELCO US

Volt setting 14.5 V.



233738

Servicing 10 SI, 12 SI, 15 SI
12 V.

Regulation: B-circuit, conversion regulator, does not require battery sense, eliminates diode trio, fast cut-in, very low drain, uses AC excited circuit

Volt setting 7.7 V.

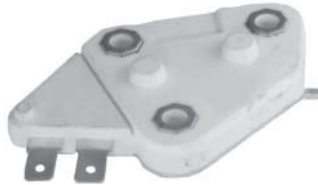

234058

Servicing 10 SI series
6 V.

Convert 12 V. to 6 V. system
Very low cut-in
One wire hook-up

Volt setting 14.7 V.



234068

Servicing CS121, -131, -144
12 V. Self ex.
1-wire system
B-circuit

Volt setting 14.8 V.



233776

Replacing 19009719
Servicing CS130D
12 V.
2.5 sec LRC

Volt setting 9.7 V.



234059

Servicing 10 SI series
8 V.
Convert 12 V. to 6 V. system
Very low cut-in
One wire hook-up

Volt setting 14.8 V.



233931

Servicing 10 SI
12 V. Self ex.
Very low cut-in,
One wire hook-up

Volt setting 27.9 V.



234060

Servicing Agricultural, Industrial, Marine
24 V.
Very low cut-in,
One wire hook-up

Replacing DELCO US

Regulator Parts



134526 A
Servicing CS 121, CS 130, CS 144
 Repair harness



232437 Std pkg 10
Replacing 1970227
Servicing 10SI, 12SI, 15SI, 17SI, 20SI, 21SI, 22SI
 Regulator terminal boot



232690
Replacing 1876806
Servicing 10SI, 12SI, 15SI, 17SI, 21SI, 30SI
 Seal for regulator terminals



137352
Servicing CS130D
 Repair Harness



232633
Servicing CS121: 10479805
 Gasket for regulator plug used w/ adaptor
 Gasket



232693
Replacing 1846938
Servicing 25SI, 26SI
 Support for regulator lead



231591
Servicing 10SI, 12SI, 15SI, 17SI, 27SI
 Repair harness for regulator



232686
Replacing 1987869
Servicing 10SI, 21SI, 22SI, 27SI/
 Type 200, 202
 Plug for regulator w/ webbed terminals



232698 Std pkg 5
Servicing CS130D
 Insulator for regulator screw
Screw: Cargo 134077



134077 Std pkg 10 A
Replacing 1989650, 1989681, 10475002
Servicing CS 121, 130
 M4-0.7 x 22 mm
 Screw



232689
Replacing 10476720
Servicing 21SI, 22SI, 27SI/200
 Cap for regulator terminals

Replacing DELCO US

Rectifiers

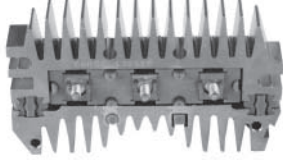

130555

Replacing 1892914
Servicing 27 SI
 Negative ground alternators
 W/ 6 diodes (50 Amp.)

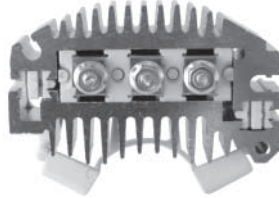

131873

Replacing 1984454
Servicing 12 SI
 W/ 6 diodes (25 Amp.)

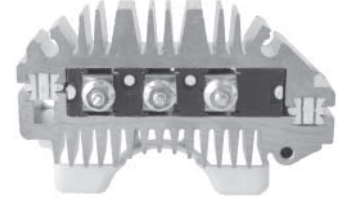

131876

Replacing 1985801
Servicing 17 SI
 W/ 6 positive diodes and 3 negative diodes
 (25 Amp.)

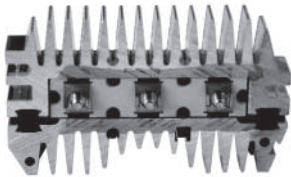

130557

Replacing 1852744
Servicing 27 SI, 1100080, 1100083
 Positive ground alternators
 W/ 6 diodes (25 Amp.)

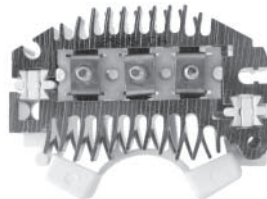

131874

Replacing 1987061
Servicing 12 SI
 W/ 6 diodes (50 Amp.)

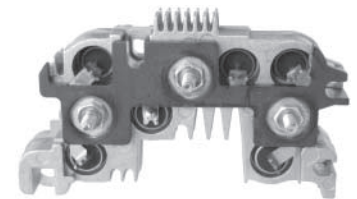

131877

Replacing 1988976
Servicing 17 SI
 W/ 6 diodes (70 Amp.)

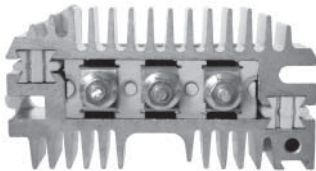

130673

Replacing 1971987
Servicing 10 SI, 20 SI, 30 SI, 32 SI, 40 SI
 W/ 6 diodes (50 Amp.)

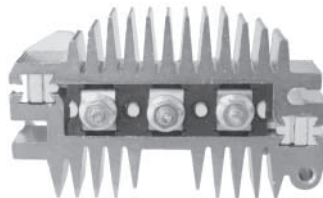

131875

Replacing 1975313
Servicing 15 SI
 W/ 6 diodes (25 Amp.)



131879

Replacing 1971670
Servicing 25 SI, 26 SI Negative grounded
 Positive
 W/ 3 diodes (35 Amp.)
Negative diodes: Cargo 133194 in frame

Replacing DELCO US

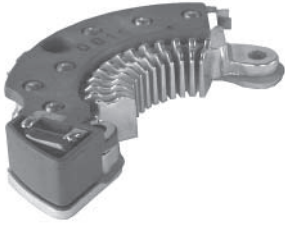

131880

Replacing 1989658
Servicing CS 121, CS 130 series
 W/ 6 avalanche diodes (50 Amp.)
 Use heat transfer compound Cargo 132987

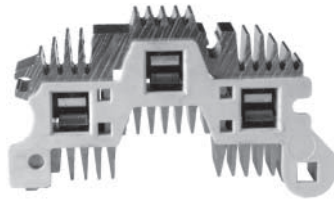

231061

Replacing 10469265
Servicing 21SI, 22SI : 1117891, -898, -913, -914, -932, -946, 19010178
 W/ 6 avalanche diodes (50 Amp.)

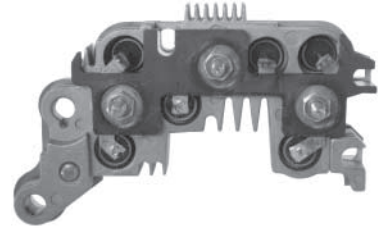

232068

Replacing 10475800
Servicing CS144: 1102625, 10479996, 10480010
 W/ 6 avalanche diodes (50 Amp.)
 Released mtg. hole

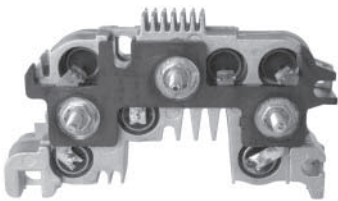

131881

Replacing 1989774
Servicing CS 144 series
 W/ 6 avalanche diodes (50 Amp.)

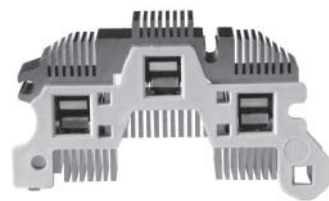

231062

Replacing 10470609
Servicing 21SI, 22SI : 10479839, 1101239, 1117838, -896, -899, -904, -916, -917, -918, -919, -920, -921, -922, -924, -926, -928, -929, -933, -934, -936, -945
 W/ 6 avalanche diodes (50 Amp.)

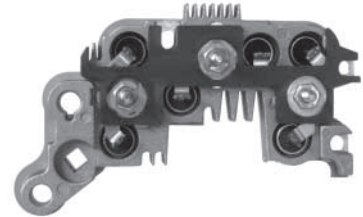

232069

Replacing 10472095
Servicing CS144: 10479821, -852, -891, -895, 10480008, -011, -018, -019, -022, -023, -024, -026, -033, -048, -051, -077, -111, -120, -122, -130, -135, -138, -139
 W/ 6 avalanche diodes (50 Amp.)



135337

Replacing 10475758
Servicing CS130D
 W/ 6 avalanche diodes (50 Amp.)
 B+ terminal M8 x 33 mm
 Use heat transfer compound Cargo 132987



231200

Replacing 10475758
Servicing CS130D
 Renault
 W/ 6 avalanche diodes (50 Amp.)
 W/ terminal W
 B+ terminal M8 x 37 mm



232070

Replacing 10492300
Servicing CS121D: 21023969, 21024727
 Saturn
 W/ 6 avalanche diodes (50 Amp.)

Replacing DELCO US



232436

Replacing 1971867
Servicing 25SI positive grd.
 W/ 3 diodes (35 Amp.)

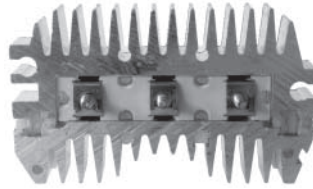

233194

Replacing 1880132
Servicing 30SI: 1117648, -649, -733, -734, -738, -746, -747, -825, -826, -827
 Insulated ground alternators
 W/ 6 diodes (50 Amp.)

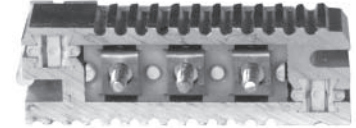

233197

Replacing 1974711
Servicing 31SI, 32SI: 1117171, -173, -180, -181, -182, -183, -185
 For oil cooled alternators
 W/ 6 diodes (50 Amp.)

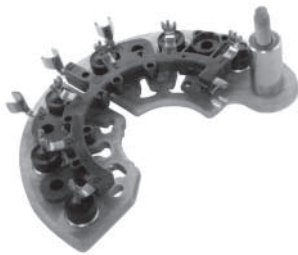

232668

Replacing 10494503
Servicing AD237, -244
 W/ 6 avalanche diodes (70 Amp.)
 O.D. 116 mm
 B+ terminal M6 x 41 mm

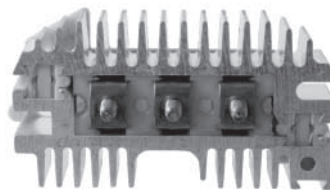

233195

Servicing 10SI
 Positive ground alternators
 W/ 6 diodes (25 Amp.)



233234

Replacing 1959828
Servicing 10DN: 1100059, -063, -064, -065, -068, -074, -553, -557, -558, -566, -567, -568, -569, -570, -571, -572, -586
 W/ 3 diodes (35 Amp.)
Negative diodes: Cargo 133194

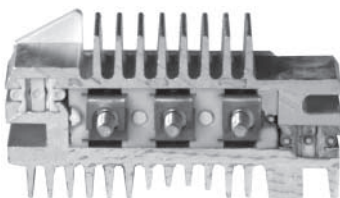

233193

Replacing 801574
Servicing 40SI: 1117142, -143, -144, -145, -146
 W/ 6 diodes (25 Amp.)

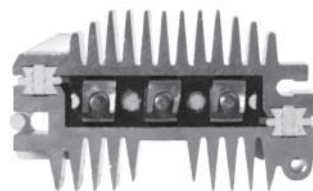

233196

Servicing 15SI
 Positive ground alternators
 W/ 6 diodes (50 Amp.)



235026

Replacing 10494744 
Servicing AD230: 10327068, -069, 10442782, -783, 10464404, -421, -438,
 W/ 6 avalanche diodes (55 Amp.)
 O.D. 116 mm
 B+ terminal M6 x 41 mm

Replacing DELCO US



235027

Servicing 7SI: 19020601, -612
W/ 6 avalanche diodes (50 Amp.)
O.D. 99 mm, w/ HD diode trio
B+ terminal M6 x 23 mm



235028

Servicing 7SI: 1902604, -608, -609, -614, -615
W/ 6 avalanche diodes (50 Amp.)
O.D. 99 mm, w/ HD diode trio
W/ P-terminal
B+ terminal M6 x 23 mm



Rectifier Parts



132047 Std pkg 5

Servicing CS 121, CS 130 series
Cover for rectifier Cargo 131880

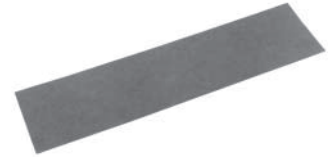

232694

Servicing CS144
124-145 Amp.
Insulator for rectifier



232730

Replacing 1969000
Servicing 25SI, 26SI
Cover for rectifier



232704

Servicing AD230, AD235, AD237
Insulator for rectifier



232682

Replacing 1970395
Servicing 25SI, 26SI
Gasket for rectifier cover



138049

Replacing 10475675
Servicing CS130D
M8-1.25 x 46 mm
B+ terminal



232681 Std pkg 5

Replacing 1968930
Servicing 25SI, 26SI
Insulator for rectifier



232661 Std pkg 5

Replacing 10474201
Servicing CS144
M6-1.0 int. M8-1.25 ext.
B+ terminal

Replacing DELCO US



232662 Std pkg 5
Replacing 10456476
Servicing CS144
 12-24 post int. M6-1.0 hole ext.
 B+ terminal
Used w/ screw: Cargo 232663



232702
Servicing 27SI/100
 10-24 int. M6-1.0 ext.
 L. 32 mm
 B+ terminal



232703 Std pkg 5
Replacing 1969002
Servicing 25SI, 26SI, neg. ground
 7/16"-14
 B+ terminal
Used w/ terminal kit: Cargo 232651



232705
Replacing 10469503
Servicing CS121
 M5-0.8 int. M6-1.0 x 9 mm ext.
 B+ terminal
Used w/ insulator: Cargo 232695



232707
Servicing CS121D: 21023969, 21024727
 M5-0.8 int. M6-1.0 ext.
 B+ terminal



232708
Servicing AD230, -237, -244
 M6-1.0, 40 mm thread
 B+ terminal



233394
Replacing 1989647
Servicing CS121, -130
 M6 x 11 mm / M5 x 10 mm
 B+ terminal



230422 Std pkg 10
Replacing 120622, 453434, 453996
Servicing CS144, 10SI, 12SI, 15SI, 17SI
 8-32 x 11/32"
 Hex nut for rectifier

Diode Trios



130556 Std pkg 5
Replacing 1977064
Servicing 27 SI



131416 Std pkg 5
Replacing 1876797
Servicing 30 SI, 1117432, 1117433, 1117437, 1117481, 1117482, 1117484



131418 Std pkg 5 **A**
Replacing 1984459
Servicing 10 SI, 12 SI, 15 SI, 17 SI, 20 SI

Replacing DELCO US



131897 Std pkg 5
Replacing 1988985
Servicing 17 SI



233198
Replacing 801572
Servicing 40SI: 1117141, -142, -143, -144, -145, -146, -147, -148, -149, -150, -151, -152



233201 Std pkg 5
Replacing 1985348, D3923
Servicing 20SI

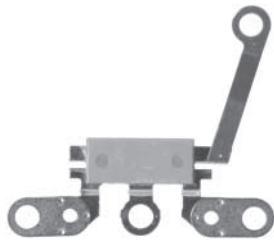

131898 Std pkg 5
Replacing 1974626
Servicing 29 SI



233199
Replacing 10472644, 10475293
Servicing 26SI: 19010000, -002, -003, -004, -005, -006, -007, -008, -009, -009, -012, -013, -014, -018, -019, -020

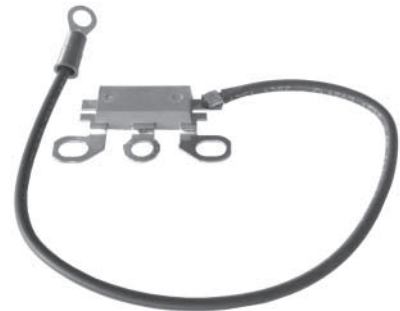

233202
Replacing 1892205, 1984198
Servicing 32SI/600



133867 HD Std pkg 5 **A**
Replacing 1987324
Servicing 20 SI 300



233200
Replacing 10491182
Servicing 33SI, 34SI

Replacing DELCO US

Also see Diode Chapter page 780

Diodes



233349 Std pkg 10
35 Amp. 200 V.
1/2" (12.7 mm) press fit
Insulated lead w/ flag terminal
Positive



233350 Std pkg 10
35 Amp. 200 V.
1/2" (12.7 mm) press fit
Insulated lead w/ flag terminal
Negative

Slip Rings



130561 Std pkg 5 **A**
Servicing 10 DN, 10 SI, 27 SI 100,
27 SI 200
Long leads
O.D. 30 mm, Shaft 18 mm, L. 27.8 mm



132295 Std pkg 10 **A**
Servicing 15 SI
O.D. 30 mm, Shaft 17 mm, L. 28.2 mm



133924 Std pkg 10 **A**
Servicing CS 121, 130
O.D. 26.1/26.4 mm, Shaft 13.2 mm,
L. 23.8 mm



136682 Std pkg 5
Servicing CS130D
O.D. 14.7 mm, Shaft 7.1 mm, L. 20.3 mm



232401 Std pkg 5
Servicing AD230, -237, -244
O.D. 15 mm, Shaft 7.1 mm, L. 20 mm



233118 Std pkg 5
Replacing 10492757
Servicing 22SI
O.D. 28 mm, Shaft 17.12 mm,
L. 32.8 mm
Used on rotors: Cargo 232821, 232822



233281 Std pkg 5
Servicing CS144
O.D. 29.5 mm, Shaft 12 mm,
L. 33.14 mm
Used on later style rotor



233936 Std pkg 5
Servicing 15SI, 17SI, CS144
O.D. 29.3 mm, Shaft 17.3 mm,
L. 33 mm

Replacing DELCO US

Brush Boxes



130548
Replacing 1965276
Servicing 10 DN
 12 V. Complete w/ brushes



131914
Replacing 1975323
Servicing 15 SI, 17 SI
 12 V. Complete w/ brushes



138053
Replacing 1979724
Servicing 15 SI Type 116
 12/24 V. Complete w/ brushes
Brush set: Cargo 140924



130549 A
Replacing 801466
Servicing 10 SI
 12 V. Complete w/ brushes



131915 A
Replacing 1989651, 10473364
Servicing CS 121, CS 130 series
 12 V. Complete w/ brushes



230681
Replacing 1988986, 1989719
Servicing 15 SI, 17 SI
 12 V. Complete w/ brushes



130558 A
Replacing 1852002
Servicing 27 SI
 12 V. Complete w/ brushes



131916 A
Replacing 1989702
Servicing CS 144 series, early type
 12 V. Complete w/ brushes
Last type: Cargo 231046



231346
Servicing CS121D: 21023969,
 21024727
 12 V. Complete w/ brushes

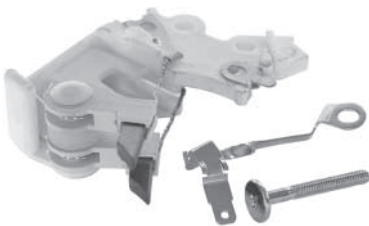

131476 A
Replacing 1894559
Servicing 10 SI, 1102918, 1102922
 12 V. Complete w/ brushes



137053
Replacing 10475746
Servicing CS130D
 12 V. Complete w/ brushes

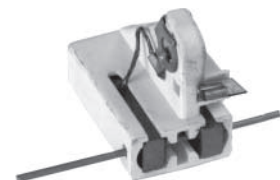

232046
Servicing CS144, late type
 12 V. Complete w/ brushes
Early type: Cargo 131916

Replacing DELCO US



232306
Replacing 10492749
Servicing 22SI
 12/24 V. Complete w/ brushes



234667
Servicing AD230, -237, -244
 12 V. Complete w/ brushes

Brush Box Parts



232691
Replacing 10493664
Servicing 22SI
 Seal for brush box



233682 Std pkg 5
Servicing AD230, -237, -244, CS130D
 Cap for brush box

Brush Sets



140134 A
Replacing 1942360, 1971523
Servicing 10 SI, 27 SI
 5 x 8 x 12.5 mm, LL. 17 mm
 12 V.



140135 A
Replacing 1876873
Servicing 27 SI 200
 5 x 8 x 18.5 mm, LL. 22 mm
 12 V.

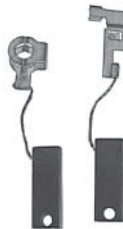

140598 A
Servicing CS 121, 130
 5 x 8 x 22.5 mm, LL. 25 mm
 12 V.



140599
Servicing CS 144
 5 x 8 x 22.5 mm, LL. 25 mm
 12 V.

Also see Bearing Chapter page 821

Replacing DELCO US



140912

Servicing CS130D
4.5 x 8 x 22 mm, LL. 36 mm
12 V.



141169

Servicing 22SI
5.5 x 8 x 48 mm, LL. 91 mm
12 V.

Special Bearings



140784

Replacing 10473711
Servicing CS 130
10/26 x 10 mm
S.R.E.



140924

Replacing 1894564
Servicing 10 SI Type 116, -136
1/4" x 7/32" x 7/8", LL. 1 3/8"
5 x 6 x 22 mm, LL. 37 mm
12/24 V.



141170

Servicing CS121D
5 x 8 x 22.5 mm, LL. 35 mm
12 V.

141002

Replacing 1989711, 10474532
Servicing CS 144
10/26 x 8 mm
W/ 2 teflon tolerance rings, S.R.E.



140925

Servicing 15 SI, 17 SI
3/16" x 5/16" x 13/16", LL. 23/32"
5 x 8 x 20.5 mm, LL. 21 mm
12 V.



RX99-100 2 Std pkg 10

Replacing 1958197
Servicing 10 DN
5 x 8 x 12.5 mm, LL. 25 mm
12 V.



140926

Replacing 1986583
Servicing 12 SI Type 100, 27 SI Type 100
1/4" x 7/32" x 7/8", LL. 1 3/8"
5.56 x 6.35 x 16.5 mm, LL. 34.9 mm
12 V.

Replacing DELCO US

Also see Bearing Chapter page 821

Needle Bearings



140120 Std pkg 10 **A**
Replacing 9436831
Servicing 10 SI, 12 SI, 15 SI, 17 SI, 27 SI
 17/23.8 x 17.4 mm
 Closed end



140240 Std pkg 10 **A**
Replacing 9433301, 9437211, 9437222
Servicing 10 DN Series
 17/23.8 x 17.4 mm



140773 Std pkg 5
Replacing 10470411, 10474368
Servicing CS 144
 17/23.8 x 17 mm
 Closed end



140136
Replacing 7451782, 9437171
Servicing 20 SI, 27 SI Type 200
 17/23.8 x 32 mm
 Closed end



140241 Std pkg 10
Replacing 1975322, 3874074
Servicing 15 SI
 17/23.8 x 20.6 mm
 Closed end



140228
Replacing 9436064
Servicing 25 SI, 27 SI, 30 SI
 22.2/30.2 x 20.5 mm



140771 Std pkg 5
Replacing 1974862
Servicing 10 SI/116, 10 SI/136
 17/23.8 x 19.6 mm
 Heavy duty, W/ double seal
 Closed end



140229
Replacing 9436063
Servicing 25 SI, 27 SI, 30 SI
 17/22.2 x 25.4 mm
 Inner race



140772 Std pkg 5
Replacing 9439542, 10472936
Servicing 15 SI/116, 21 SI
 17/23.8 x 22 mm
 W/ double seal
 Closed end

Also see Bearing Chapter and Pulley Survey

Replacing DELCO US

Roller Bearings



141087

Replacing 7451642, 12333738

Servicing 20DN, 25Si

22/40 x 11.9 mm

Used w/ Inner race: Cargo 141088



141088

Replacing 12333739

Servicing 20DN, 25Si

17 x 22.1 x 17.5 mm

Inner race

Used w/ Roller bearing: Cargo 141087



141111

Servicing 15SI, 17SI, CS144

10 x 17 x 15 mm

Inner race

Fan & Pulleys



131854

Replacing 1969481

Servicing 25 SI, 27 SI, 29 SI, 30 SI, 40 SI

O.D. 167 mm, Bore 22.23 mm (7/8")

Fan



133926

Replacing 10495204

Servicing CS 121

O.D. 117 mm, Bore 17 mm

Fan



133930

Replacing 1989581

Servicing CS 130

O.D. 123 mm, Bore 17 mm

Fan



133931

Servicing CS 130

O.D. 95 mm

Internal fan



133943

Replacing 1978026

Servicing 15 SI, 17 SI, CS 144

O.D. 143 mm, Bore 17 mm

Fan

Baffle: Cargo 133944



233113

Replacing 800594

Servicing 10DN, 10SI

O.D. 136 mm, Bore 17 mm

Fan



233826

Replacing 10467272, 10471121

Servicing 20SI, 21SI, 22SI

O.D. 146 mm, Bore 22.23 mm (7/8")

Fan



131176

Replacing 1953071, 1962567

Servicing 25 SI, 27 SI/200, 29 SI, 30 SI

O.D. 78.8 mm, Bore 22.23 (7/8"),

W. 39.8 mm

Double, B-type belt

Replacing DELCO US

Also see Pulley Survey page 809



133936

Replacing 1978065, 1978067
Servicing 10 SI, 12 SI, 15 SI, 17 SI, 27 SI, CS 130
 O.D. 64.5 mm, Bore 17 mm, W. 16.4 mm, Single



133941

Replacing 1979846, 1984964
Servicing 10 SI, 12 SI, 15 SI, 17 SI, CS 121, 130, 144
 O.D. 55.1 mm, Bore 17 mm, W. 31.88 mm, 6 grooves



137056

Replacing 10475747
Servicing 10480017, -043, -072, -190
 O.D. 56.6 mm, Bore 17 mm, W. 30.2 mm, 6 grooves



133938

Replacing 1979746, 1989104
Servicing 10 SI, 12 SI, 15 SI, 17 SI, CS 130, 144
 O.D. 60.3 mm, Bore 17 mm, W. 33 mm, 6 grooves



133942

Replacing 10495231
Servicing 12 SI, CS 121, 130
 O.D. 53.2 mm, Bore 17 mm, W. 30.3 mm, 5 grooves



139452

Replacing 10475460
Servicing 10479914, 10479955, 3493814, 3493855
 O.D. 55.1 mm, Bore 17 mm, W. 31.3 mm, 6 grooves



133939

Replacing 1989030
Servicing 12 SI, 17 SI, CS 130
 O.D. 54.9 mm, Bore 17 mm, W. 25.7 mm, 4 grooves



133951

Replacing 1961408, 1970830
Servicing 10 DN, 10 SI, 15 SI
 O.D. 69.1 mm, Bore 17 mm, W. 38 mm, Double



230526

Replacing 10484670, F-230753
Servicing AD237 series
 O.D. 56.7 mm, Bore 17 mm, W. 35.2 mm, 6 grooves, w/ Free wheel
Pulley tool: Cargo 210843



133940

Replacing 1987648
Servicing CS 130
 O.D. 52.1 mm, Bore 17 mm, W. 31.9 mm, 4 grooves



133952

Replacing 1877007
Servicing 10 DN, 10 SI
 O.D. 71.5 mm, Bore 17 mm, W. 50.2 mm, Double, B-type belt



230531

Replacing 1986832
Servicing 10 SI, 12 SI, 1100297, 1105025, -027, -028, -041, -042, -561, -562
 O.D. 70.2 mm, Bore 17 mm, W. 30.9 mm, 6 grooves

Also see Pulley Survey
page 809

Replacing DELCO US



230532

Replacing 10499041

Servicing CS 130: 1101231, -277, -278, -596, 10479909, -913, 10480114, -115, -134
O.D. 61.5 mm, Bore 17 mm, W. 32.1 mm, 5 grooves



230826

Replacing 3002323

Servicing 30SI
O.D. 77.2 mm, Bore 22.23 mm (7/8"), W. 63.2 mm, 5 grooves



232084

Servicing 10SI: 1100370, -428, -642, -731

O.D. 65.8 mm, Bore 17 mm, W. 23.5 mm, Single, B-type belt



230533

Replacing 1987524, 10497100, 10498446

Servicing 12 SI, CS 121, -130: 1101144, -145, -150, -151, -461, -464, -605, 1105508, -541, -604, -620, -624, -701
O.D. 61.4 mm, Bore 17 mm, W. 30.6 mm, 5 grooves



232080

Servicing 10SI Type 116

O.D. 81.3 mm, Bore 17 mm, W. 23 mm, Single, B-type belt



232085

Servicing 27SI

O.D. 62.8 mm, Bore 17 mm, W. 20.1 mm, Single, 11 mm belt



230535

Replacing 1893675, 1939845, 1949355

Servicing 10 SI, 12 SI, 15 SI, 27 SI
O.D. 65.3 mm, Bore 17 mm, W. 22.2 mm, Single



232081

Servicing 10SI Type 116

O.D. 107.2 mm, Bore 17 mm, W. 37.8 mm, Single, C-type belt



232086

Replacing 1984572

Servicing 10SI, 12SI: 1100199, -201, -202, -227, -236, -249, -255, -265, -273, 1101449, 1105050, -058, -059, -060
O.D. 64.4 mm, Bore 17 mm, W. 42.9 mm, Double



230536

Replacing 1846787, 1964758, 1968354

Servicing 10 DN, 10 SI, 12 SI, 15 SI, 27 SI
O.D. 65.5 mm, Bore 17 mm, W. 38.1 mm, Double



232082

Servicing 10SI Type 116

O.D. 111.6 mm, Bore 17 mm, W. 59.7 mm, Double, C-type belt



232087

Replacing 10473389

Servicing CS130: 10479963, 10480028, -104
O.D. 54.7 mm, Bore 17 mm, W. 28 mm, 5 grooves

Replacing DELCO US

Also see Pulley Survey page 809



232088

Replacing 10497728
Servicing CS121: 1101175, -176
 O.D. 56.9 mm, Bore 17 mm, W. 42.9 mm,
 6 grooves



232092

Replacing 10495514
Servicing 12SI, CS130: 1101582,
 1105621, -623, -663, -710, 10479993
 O.D. 55.1 mm, Bore 17 mm, W. 28.4 mm,
 4 grooves



232096

Replacing 10476225
Servicing CS130D: 10479981, -984,
 10480187, -188, -252
 O.D. 67.1 mm, Bore 17 mm, W. 29.5 mm,
 6 grooves



232089

Replacing 1987376
Servicing 17SI: 1100278, -280, -281,
 -282, 10479858
 O.D. 50.3 mm, Bore 17 mm, W. 37.3 mm,
 6 grooves



232093

Replacing 10469511
Servicing CS121: 1101626, 10479805,
 10480095
 O.D. 53.1 mm, Bore 17 mm, W. 30.5 mm,
 5 grooves



232097

Replacing 10476389
Servicing CS130D: 10480052, -071,
 -119, -207, -217, -233, -235, -236, -237,
 -259, -263, -299, -332, -353
 O.D. 50.6 mm, Bore 17 mm, W. 28.8 mm,
 6 grooves



232090

Replacing 10495541
Servicing CS144: 1101133, -270, -296,
 O.D. 55.2 mm, Bore 21 mm, W. 37.2 mm,
 6 grooves
Taper collar: Cargo 232169 (for 17 mm shaft)



232094

Replacing 10471713
Servicing CS144: 1101578, -579, -847,
 O.D. 58.2 mm, Bore 21 mm, W. 38.9 mm,
 6 grooves
Taper collar: Cargo 232169 (for 17 mm shaft)



232098

Replacing 1987810
Servicing 10SI, 15SI, CS130: 1105429,
 O.D. 61.8 mm, Bore 21 mm, W. 45.3 mm,
 8 grooves
Taper collar: Cargo 232170 (for 17 mm shaft)



232091

Replacing 10496580
Servicing CS130: 10479902, -911,
 10480025, -036, -037, -068, -136,
 1101101, -107, -127, -142, -143, -148
 O.D. 50.5 mm, Bore 17 mm, W. 31.3 mm,
 6 grooves



232095

Servicing 12SI
 O.D. 58 mm, Bore 21 mm, W. 45 mm,
 8 grooves
Taper collar: Cargo 232171 (for 17 mm shaft)



232099

Replacing 10476070
Servicing CS144: 10480120
 O.D. 55.1 mm, Bore 17 mm, W. 37.2 mm,
 6 grooves

Also see Pulley Survey
page 909

Replacing DELCO US



232100

Replacing 10477425
Servicing CS130D: 10480182, -240, -262, -264, -301
O.D. 61.5 mm, Bore 17 mm, W. 30.5 mm, 6 grooves



232104

Servicing 25SI
O.D. 122.3 mm, Bore 22.23 mm (7/8"), W. 59.1 mm, Double, B-type belt



232108

Servicing 25SI, 29SI, 30SI
O.D. 87.8 mm, Bore 22.23 mm (7/8"), W. 55.5 mm, Tripple, B-type belt



232101

Replacing 10489052
Servicing CS130D: 10480076, -078, -079, -184, -289
O.D. 56.5 mm, Bore 17 mm, W. 27.4 mm, 5 grooves



232105

Servicing 25SI
O.D. 104.8 mm, Bore 22.23 mm (7/8"), W. 33.3 mm, Single, C-type belt



232109

Replacing 830279
Servicing 21SI, 22SI, 25SI, 26SI, 30SI, 33SI, 34SI: 1102553, 1117067, -240
O.D. 85 mm, Bore 22.23 mm (7/8"), W. 44.2 mm, Double, B-type belt



232102

Replacing 10457238
Servicing CS144: 10480186, -204, -205, -227
O.D. 61.4 mm, Bore 17 mm, W. 36.9 mm, 6 grooves



232106

Servicing 30SI
O.D. 75.5 mm, Bore 22.23 mm (7/8"), W. 49.7 mm, Double, B-type belt



232110

Replacing 1987932
Servicing 20SI, 21SI
O.D. 90.6 mm, Bore 22.23 mm (7/8"), W. 34 mm, Single, B-type belt



232103

Replacing 1938553
Servicing 25SI, 29SI, 30SI
O.D. 87.9 mm, Bore 22.23 mm (7/8"), W. 59.4 mm, Double, B-type belt



232107

Servicing 27SI type 205
O.D. 72.6 mm, Bore 22.23 mm (7/8"), W. 55.9 mm, Tripple, B-type belt



232111

Servicing 21SI
O.D. 89.4 mm, Bore 22.23 mm (7/8"), W. 39.6 mm, Double, B-type belt

Replacing DELCO US

Also see Pulley Survey page 809



232112

Servicing 25SI, 30SI
O.D. 70.8 mm, Bore 22.23 mm (7/8"),
W. 40.4 mm,
9 grooves



232116

Replacing 10499362
Servicing 22SI, 27SI: 1101287, -288,
-289
O.D. 57.2 mm, Bore 22.23 mm (7/8"),
W. 38.1 mm,
8 grooves



233536

Servicing 10480214, -215
O.D. 59.6 mm, Bore 17 mm, W. 23.7 mm,
4 grooves



232113

Replacing 10468768
Servicing 20SI, 21SI
O.D. 55 mm, Bore 22.23 mm (7/8"),
W. 35.4 mm,
7 grooves



232117

Servicing 20SI
O.D. 93.6 mm, Bore 22.23 mm (7/8"),
W. 93.3 mm,
Double, 22 mm belt



210843

Tool to be used for mounting and
dismounting of free wheel pulleys
Shaft L. 74 mm.



232114

Replacing 10468526
Servicing 21SI, 25SI, 26SI, 30SI:
1117267, -270, -808, -813, -955, -958,
19010013, -159, -162
O.D. 82.6 mm, Bore 22.23 mm (7/8"),
W. 37.6 mm,
8 grooves



232118

Servicing 20SI
O.D. 95 mm, Bore 22.23 mm (7/8"),
W. 82.9 mm,
Double, C-type belt

210948

As Cargo 210843, but
Shaft L. 114 mm.



232115

Replacing 10474925
Servicing 21SI, 22SI, 33SI, 34SI:
1117931, -932, -933, 19010136, -137
O.D. 69.2 mm, Bore 22.23 mm (7/8"),
W. 42.1 mm,
8 grooves



232167

Replacing 1846529
Servicing 1102867, -927, 1103126,
1105166
O.D. 78.3 mm, Bore 17 mm, W. 25.6 mm,
Single, C-type belt

Replacing DELCO US

Fan & Pulley Parts



133945 Std pkg 10 **A**
Replacing 1959991
Servicing 10 DN, 10 SI, 15 SI, CS 121, 130
 O.D. 22.2 mm, Bore 17 mm, Th. 5.0 mm
 Spacer



133949 Std pkg 10 **A**
Replacing 1984476, 1985999
Servicing 12 SI, 17 SI, CS 144
 O.D. 25.4 mm, Bore 17 mm, Th. 7.0 mm
 Spacer



137196 Std pkg 5
Replacing 10469875
Servicing CS130
 O.D. 28.5 mm, Bore 17 mm, Th. 1 mm
 Spacer



133946 Std pkg 10 **A**
Replacing 1978064, 1986000
Servicing 10 SI, 12 SI, 15 SI, CS 121, 130
 O.D. 25.5 mm, Bore 17 mm, Th. 10 mm
 Spacer



137193 Std pkg 5
Replacing 1989630
Servicing CS 121, CS130
 O.D. 25.5 mm, Bore 17 mm, Th. 5.3 mm
 Spacer



137197 Std pkg 5
Servicing CS130D
 O.D. 46.6 mm, Bore 17 mm, Th. 6.1 mm
 Spacer



133947 Std pkg 10 **A**
Servicing CS 130
 O.D. 25.5 mm, Bore 17 mm, Th. 3.0 mm
 Spacer



137194 Std pkg 5
Replacing 1985999, 10475000
Servicing 15 SI, 17 SI, CS 144
 O.D. 25.5 mm, Bore 17 mm, Th. 5.8 mm
 Spacer



137198 Std pkg 5
Replacing 10470412
Servicing CS 144
 O.D. 25.5 mm, Bore 17 mm, Th. 6.5 mm
 Spacer



133948 Std pkg 10 **A**
Replacing 1963139, 1975350
Servicing 10 DN, 10 SI, 12 SI, 15 SI, 17 SI
 O.D. 22.2 mm, Bore 17 mm, Th. 10.0 mm
 Spacer



137195 Std pkg 5
Servicing CS 121
 O.D. 36 mm, Bore 17 mm, Th. 3 mm
 Spacer



137200 Std pkg 5
Replacing 10470075
Servicing CS121
 O.D. 33 mm, Bore 17 mm, Th. 5 mm
 Spacer

Replacing DELCO US



232748

Replacing 1969046
Servicing 20SI, 27SI/200, 29SI
 22.23 x 35.5 x 8 mm
 Spacer for fan



232749

Replacing 1968890, 10497219
Servicing 25SI, 30SI
 22.23 x 35 x 13.7 mm
 Spacer for fan



232750

Replacing 1968885
Servicing 25SI, 30SI
 25.1 x 35 x 28 mm
 Spacer for internal fan



232169

Replacing 10495168
Servicing 17SI, CS130D, CS144:
 10479817, 1101133, -270, -296, -329,
 -330, 1105657
 17 x 22 x 13.5 mm
 Taper collar
 For pulley: Cargo 232090, 232094



232170

Replacing 1987801
Servicing 10SI, 15SI, CS130:
 1105429, -537, -558, -559, -560, -574
 17 x 22 x 17 mm
 Taper collar for pulley
 For pulley: Cargo 232098



232171

Servicing 12SI
 17 x 20 x 13.5 mm
 Taper collar for pulley
 For pulley: Cargo 232095

Repair Kits



138131

Servicing 25 SI, 26 SI



131504 A

Replacing 1846900
Servicing 10 SI, 12 SI, 15 SI, 17 SI,
 CS 144
 12-24 int. 12-24 ext.
 B+ terminal kit



133928 A

Servicing CS 121, 130
 M5-0.8 int. M6-1.0 ext.
 B+ terminal kit



133935 A

Replacing 10456489
Servicing CS 130
 M5-0.8 int. M6-1.0 ext. hole
 B+ terminal kit

Replacing DELCO US



135005 A
Replacing 10479702, 1975471
Servicing 10 SI, 12 SI, 15 SI, 17 SI, CS 144
 12-24 int. M6-1.0 ext.
 B+ terminal kit, (Metric)



232652
Replacing 1846901
Servicing 27SI/100
 12-24 int. 12-24 ext.
 B+ terminal kit



232646
Replacing 1959833
Servicing 10DN series
 10-32 x 1 1/4"
 Ground terminal kit



232647
Replacing 1959832
Servicing 10DN series
 12-24 x 1 3/8"
 B+ terminal kit



232654
Replacing 1876897, 10497168
Servicing 30SI
 1/4"-28 x 1 1/2"
 B+ terminal kit



232648
Replacing 1851714
Servicing 10SI, 12SI, 15SI, 17SI
 8-32 x 1/8" x 1/4"
 Regulator terminal kit



232649
Replacing 1894626, 1974414
Servicing 20SI, 29SI, 30SI, 34SI
 1/4"-28 x 1 3/16"
 B+ terminal kit



232656
Replacing 10456417
Servicing 21SI, 22SI
 12-24 int. 1/4"-28 ext.
 B+ terminal kit



232650
Replacing 1894627
Servicing 20SI, 29SI, 33SI, 34SI
 Regulator terminal kit



232651
Replacing 1971674
Servicing 25SI, 26SI
 1/4"-20 int. 7/16"-16 ext.
 B+ terminal kit



232657
Replacing 10456427
Servicing 21SI, 22SI
 12-24 int. 5/16"-18 ext.
 B+ terminal kit



232653
Replacing 1852519
Servicing 27SI
 8-32 int. 1/8" x 1/4"
 Regulator terminal kit

Replacing DELCO US



232658
Replacing 10479708
Servicing 21SI, 22SI
 8-32 int. 10-24 ext.
 Regulator / I terminal kit



232659
Replacing 10479703
Servicing 21SI, 22SI
 8-32 int. M4-0.7 ext.
 Regulator / I terminal kit



232660
Replacing 10457159
Servicing 21SI
 8-32 int. 1/8" x 1/4" ext.
 Regulator terminal kit



232706
Replacing 10457159
Servicing 21SI, 22SI
 8-32 int. 10-24 ext.
 Regulator terminal kit

Sundry Parts



137054
Replacing 10475745
Servicing CS130D
 Insulator for Stator lead



232699
Servicing AD230, -237, -244
 Insulator for stator leads



191307 Std pkg 10
Replacing 1989649
Servicing CS 121, 130
 M5-0.8
 Hex nut



233435 Std pkg 10
Replacing 1851808
Servicing 10SI, 12SI, 15SI, 17SI, 20SI,
 21SI, 22SI, 25SI, 26SI, 27SI, 29SI, 30SI,
 33SI, 34SI, CS144
 8-32 x 11/32" x 1/8"
 Nut for regulator terminal



132581 Std pkg 10 **A**
 5.0 x 7.3 - 14.3 x 4 mm
 Insulator bushing



132582 Std pkg 10 **A**
 6.35 x 14.73 - 15.08 x 6 mm
 Insulator bushing



135763 Std pkg 5
 3.7 - 11.4 x 13.8 mm
 Insulator



232695
Servicing CS121
 I.D. 5 mm
 Insulator
Used w/ B+ terminal: Cargo 232705

Replacing DELCO US



232696 Std pkg 5
Replacing 10470416
Servicing CS144
 Insulator for B+ terminal
Used in bracket S.R.E.: Cargo 232282, 232283, 232287



233280 Std pkg 5
Servicing AD230, -237, -244
 O.D. 10 mm, I.D. 8 mm
 Insulator for B+ terminals



232697
Replacing 10469137
Servicing 21SI
 5.5 mm square hole
 Insulator



232746
Servicing AD230, -237, -244
 6 x 13 x 25 mm
 Spacer for B+ terminal



232684
Replacing 801494
Servicing 10SI marine
 Seal for B+ terminal



133944
Replacing 1987614
Servicing 17 SI, CS 144
 Baffle
Used with fan: Cargo 133943



134076
Servicing CS 121
 O.D. 113 mm
 Baffle



137129
Replacing 1989655
Servicing CS130
 O.D. 121 mm
 Baffle



231359
Replacing 10495213
Servicing CS121: 1101531, -563, -564, -816
 O.D. 114 mm
 Baffle



231360
Servicing CS121D: 21023969, 21024727
 O.D. 114 mm
 Baffle



232760
Replacing 10474090
Servicing CS130: 10479998, 10480105, -265
 O.D. 121 mm, I.D. 72.5 mm
 Baffle



137128 Std pkg 5
Servicing CS130
 2.6 x 6.6 mm
 Pin for baffle and cover

Replacing DELCO US



134656 A
Servicing CS 130
 M6 x 21 mm
 Round to square terminal adaptor kit

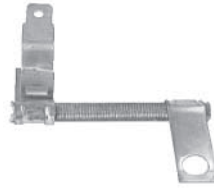

230685
Replacing 1984826
Servicing 1105613, -656,
 10479858, -870
 200 Ohm Resistor



233744
Replacing 10475016
Servicing 3493823, 10479914, -918,
 -947, -955
 Capacitor



232676
Replacing 10474214
Servicing CS144: 1101579, 1102625,
 10479966, 10480009, -010, -012, -034,
 -116
 Terminal block



233119
Replacing 1988972
Servicing 17SI, 21SI, 33SI, 34SI:
 1117932, -933, -934, -936, -937, -940,
 -942, -944, -945, -946, -947, -948, -949
 1.5 μ F.
 Capacitor



234297
Replacing 801824, 1959455, 1971411
Servicing 10DN, 27SI type 100, 29SI
 0.5 μ F. 6.5 mm (1/4") eyelet
 LL. 45 mm (1 3/4")
 Capacitor



233423
Replacing 1986132
Servicing 15SI type 116
 Terminal for regulators



233205
Replacing 1989703
Servicing CS144
 1.5 μ F.
 Capacitor



234298
Replacing 830890, 1976364, 1978146
Servicing 10SI, 12SI, 15SI, 17SI, 27SI
 1.5 μ F. 4 mm (5/32") eyelet
 LL. 50 mm (2")
 Capacitor



230684 Std pkg 5
Replacing 830478
Servicing 10 SI, 12 SI, 15 SI, 17 SI
 40 Ohm Resistor



233206
Replacing 1988873
Servicing 10SI, 12SI, 15SI, 27SI
 1.5 μ F.
 Capacitor



234299
Replacing 1885444, -445, 1894481
Servicing 20SI
 1.5 μ F. 7 mm (9/32") eyelet
 LL. 51 mm (2")
 Capacitor

Replacing DELCO US



234300
Replacing 10474443
Servicing 30SI
 1.5 μ F. 4 mm (5/32") eyelet
 LL. 122 mm (4 3/4")
 Capacitor



232714 Std pkg 5
Replacing 801815
Servicing 27SI
 L. 54.4 mm
 Connector, B+ terminal to rectifier



232718 Std pkg 5
Replacing 10467404
Servicing 21SI, 22SI
 L. 46.1 mm
 Connector, regulator to B+ terminal



232711
Replacing 1894464
Servicing 20SI
 L. 78 mm (3")
 Connector, B+ terminal to rectifier



232715 Std pkg 5
Replacing 1974627
Servicing 29SI
 L. 66 mm (2 5/8")
 Connector



232719 Std pkg 5
Replacing 10468944
Servicing 21SI, 22SI
 Connector, regulator to I-terminal



232712 Std pkg 5
Replacing 1894462
Servicing 20SI
 L. 55.2 mm
 Connector, rectifier to regulator stud



232716 Std pkg 5
Replacing 10497789
Servicing CS144
 Connector, rectifier to regulator



232720 Std pkg 5
Servicing 10SI/110 marine
 8-32 threaded hole, ground
 Connector



232713 Std pkg 5
Replacing 1894473
Servicing 20SI
 L. 81 mm (3 3/16")
 Connector, rectifier to regulator



232717 Std pkg 5
Replacing 10467339
Servicing 21SI, 22SI
 Connector, rectifier to regulator w/ R-location



232721 Std pkg 5
Replacing 10468945
Servicing 21SI
 Connector, rectifier to regulator

Replacing DELCO US



232722 Std pkg 5
Servicing 33SI, 34SI
 L. 33 mm (1 9/32")
 Connector, rectifier to regulator



232634 Std pkg 5
Replacing 1876805
Servicing 30SI
 Stator leads grommet



232709
Replacing 1876080, -809, 1964363
Servicing 10SI, 27SI/200 Neg. ground, 30SI*
 L. 70 mm (2 3/4"), O.D. 5 mm
 Wire lead, rectifier to regulator stud,
 * relay terminal to rectifier



232723 Std pkg 5
Servicing 33SI, 34SI
 L. 65 mm (2 9/16")
 Connector, B+ terminal to rectifier



232680 Std pkg 5
Replacing 1968996
Servicing 25SI
 Leed support 5 slots
 Grommet



232710 Std pkg 5
Replacing 1876151, -807, 10497661
Servicing 20SI, 26SI, 27SI/200, 30SI
 L. 95 mm (3 3/4"), O.D. 5 mm
 Wire lead, regulator to I-terminal



232724 Std pkg 5
Servicing 33SI, 34SI
 L. 88.5 mm (3 1/2")
 Connector, rectifier to regulator



232685
Replacing 1968900
Servicing 25SI, 26SI
 Stator leads grommet



232688
Servicing 22SI, 33SI, 34SI
 Dampener for diode trio



232725 Std pkg 5
Servicing 33SI, 34SI
 L. 50 mm (1 31/32")
 Connector, regulator to I-terminal

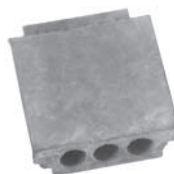

232687
Replacing 1974629
Servicing 29SI, 33SI, 34SI
 Stator leads grommet



232692
Replacing 10492752
Servicing 22SI
 17 x 34 x 2 mm
 Felt washer

Replacing DELCO US



232726 Std pkg 10
Repair lead for 1/2" press fit diodes



232769 Std pkg 5
Replacing 1968891
Servicing 25SI, 30SI
Heat cap

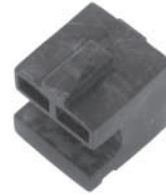

232758
Replacing 801548
Servicing 10SI/116, 27SI/200, 30SI
Voltage adjustment block
Cap: Cargo 232759
Bracket: Cargo 232752



232761
Servicing 27SI/200
150 Ohm.
Resistor, connects from battery terminal to pin-type R-terminal for faster cut-in speed



232755 Std pkg 5
Replacing 1876813
Servicing 25SI, 26SI, 30SI, 33SI, 34SI
Dust cap



232752 Std pkg 10
Replacing 1852043, 1952043
Servicing 10SI, 27SI/200, Cargo 232758
Bracket for voltage adjustment block



232762 Std pkg 5
Servicing 10SI, 12SI, 15SI, 17SI, 27SI
Adaptor plug, extends wire harness to allow alternative clock positions



232756
Servicing CS121
3 terminal w/o built in circuitry
Adaptor
Gasket: Cargo 232633



232759
Replacing 801532
Servicing 801548, Cargo 232758
Cap for voltage adjustment block



232768
Replacing 1988381
Servicing 10SI marine: 1100180, -267, 1103113, -114, -193, 1105064, -065, -078, -088, -097
Plug, 2-wire connection



232757
Servicing CS121: 10480095, -096
3 terminal, oval shape
Adaptor



230421 Std pkg 10
Replacing 1956975
Servicing 10 DN, 10 SI, 12 SI, 15 SI, 17 SI
10-24 x 2 1/8"
Thru bolt

Replacing DELCO US



232051 Std pkg 10
Replacing 1989624, 1047399
Servicing CS121, CS130
 M5-0.8 x 66 mm
 Thru bolt



232640 Std pkg 10
Replacing 1968991
Servicing 25SI, 30SI
 10-24 x 3 5/8"
 Thru bolt



232663 Std pkg 5
Servicing CS144
 M6-1.0 x 15 mm
 Screw
Used w/ B+ terminal: Cargo 232662



232637 Std pkg 10
Replacing 1894445, 1989690
Servicing 20SI, 21SI, 29SI, CS144
 10-24 x 2 1/2"
 Thru bolt



232641 Std pkg 10
Servicing 25SI, 26SI, 30SI
 10-24 x 3 7/8"
 Thru bolt



233425 Std pkg 10
Replacing 1876681
Servicing 10SI, 12SI, 15SI, 17SI
 8-32 x 1 1/8"
 Fixing screw w/ insulator for brush holder



232638 Std pkg 10
Replacing 10491448
Servicing 22SI, 27SI
 1/4"-20 x 2 9/16"
 Thru bolt



232642 Std pkg 10
Servicing 27SI
 1/4"-20 x 2 1/2"
 Thru bolt



233426 Std pkg 10
Replacing 830338
Servicing 20SI, 30SI
 8-32 x 1 5/16", w/ att. conical washer
 Fixing screw for rectifier



232639 Std pkg 10
Replacing 10491236
Servicing 30SI, 34SI
 1/4"-20 x 3 3/4"
 Thru bolt



233422 Std pkg 10
Replacing 10475769
Servicing CS130D
 M6-1 x 62 mm
 Thru bolt



233427 Std pkg 10
Replacing 1974020
Servicing 10SI
 8-32 x 1 5/16" slotted
 Fixing screw for brush holder

Replacing DELCO US



233428 Std pkg 10
Replacing 1846955, 1847807
Servicing 20SI
 8-32 x 1/2"
 Fixing screw for capacitor



233432 Std pkg 10
Replacing 1894458, 1894586
Servicing 20SI, 21SI, 22SI, 26SI, 29SI, 30SI, 33SI, 34SI
 8-32 x 1"
 Fixing screw for regulator



233429 Std pkg 10
Replacing 1876682, 1984458, 1988971
Servicing 10SI, 12SI, 15SI, 17SI, 20SI, 21SI, 22SI, 26SI, 27SI, 29SI, 30SI, 33SI, 34SI
 8-32 x 1 1/8", w/ att. conical washer
 Fixing screw for regulator/rectifier



233433 Std pkg 10
Replacing 1894641
Servicing 20SI, 29SI
 10-24 x 1/2"
 Fixing screw for cover



233430 Std pkg 10
Replacing 1851612
Servicing 10SI, 12SI, 15SI, 17SI
 8-32 x 1/2"
 Fixing screw for capacitor



233434 Std pkg 10
Replacing 1968945
Servicing 20SI, 25SI, 26SI, 29SI, 30SI
 10-24 x 13/16"
 Fixing screw for stationary coil



233431 Std pkg 10
Replacing 1976061
Servicing 20SI, 26SI, 29SI, 30SI, 33SI, 34SI, CS144
 8-32 x 31/32"
 Fixing screw w/ insulator for regulator



233681 Std pkg 10
Replacing 10475737
Servicing CS130D
 M4 x 21 mm
 Screw w/ insulator

Replacing DUCELLIER

Rotors



131148

Replacing 581047
Servicing 513005AB
 12 V. 43 Amp.
 L. 153 mm, O.D. 88 mm, Shaft 17 mm



131960

Replacing 581175
Servicing 513001, 513002, 513004,
 513010, 513014, 514005, 514007,
 514010
 12 V. 40 Amp.
 L. 137 mm, O.D. 89 mm, Shaft 17 mm

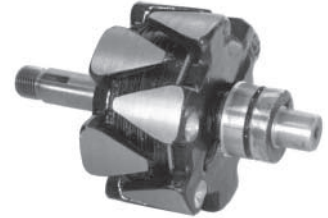

231208

Replacing 611234, 618770, 618780
Servicing 7522A, -B, -C, 7532A, -B, -C,
 -D, 7534A, -B, -C, -D
 12 V. 50 Amp.
 L. 130 mm, O.D. 81 mm, Shaft 17 mm



131149

Replacing 618779, 581098
Servicing 133402, 7549A,B,C,D,E,F,G,
 7550A,B,C,D,E,F,G, 7578A,B,C,D,
 7591A,B,C,D,E, 7597A,B,C,D,E,F
 12 V. 40 Amp.
 L. 136 mm, O.D. 88 mm, Shaft 17 mm



133176

Replacing 581080
Servicing 7577
 12 V. 35 Amp.
 L. 149 mm, O.D. 89 mm, Shaft 17 mm



231209

Replacing 581104
Servicing 512008
 12 V. 35 Amp.
 L. 138 mm, O.D. 88 mm, Shaft 17 mm



131959

Replacing 581110
Servicing 7485C,D,E, 516013, 516015,
 516016, 516017, 516024, 516035,
 516078, 516044, 516048, 516050
 12 V. 70 Amp.
 L. 156 mm, O.D. 89 mm, Shaft 17 mm



134361

Replacing 581192
Servicing 516023A, B, CD, 516025A,
 BC, 516033A, BC, 516058A
 12 V. 50 Amp.
 L. 170 mm, O.D. 88 mm, Shaft 17 mm

Replacing DUCELLIER

Stators



130157

Replacing 669423, 690217
Servicing 7522C, 7532B, 7534B
 12 V. 30 Amp.
 O.D. 117.5 mm, I.D. 81.9 mm, W. 16.7 mm



131974

Replacing 690411
Servicing 7584
 12 V. 75 Amp.
 O.D. 127 mm, I.D. 88.1 mm, W. 26.8 mm



132373

Replacing 690856
Servicing 515018A, 516020A,B,C,D,
 516024A,B,C,D, 516035A,B,C,
 516037A,B,C, 516038A,B,C
 12 V. 60 Amp.
 O.D. 126.9 mm, I.D. 88.3 mm, W. 27.3 mm



130164

Replacing 610697, 690789
Servicing 7562A,B,C,D,E,F,
 512008B,C,D,E, 512010C
 12 V. 40 Amp.
 O.D. 116.9 mm, I.D. 88.6 mm, W. 23.4 mm



131975

Replacing 690847
Servicing 514006, 514011, 514012,
 514013, 516006, 516023, 516025,
 516026, 516033, 516040, 516041
 12 V. 50 Amp.
 O.D. 127.1 mm, I.D. 88.6 mm, W. 27.3 mm



131973

Replacing 690685
Servicing 516013, 516015, 516016,
 516017, 516046, 516050, 516065
 12 V. 70 Amp.
 O.D. 127 mm, I.D. 88.8 mm, W. 28.5 mm



132371

Replacing 690298
Servicing 7575D, 7575E, 515013A,
 515015A, 515016A, 516003A,B,C
 516012A,B
 12 V. 40 Amp.
 O.D. 126.8 mm, I.D. 88.8 mm, W. 24.8 mm

Replacing DUCELLIER

Brackets D.E.



136850

Replacing 669132
Servicing 7584B,C,D,E, 516013A,B,C,
 515015A
Bearing: Cargo 140087

Brackets S.R.E.



136849

Replacing 690683, 690791
Servicing 7584E, 516013A,B,C,
 516015A
Bearing: Cargo 140081

Bracket Parts



136115

Replacing 581185, 690883
Servicing 516024B,C,D, 516038, 516044
 Mounting bracket



136116

Servicing 516012, 516014
 Mounting bracket



231350

Replacing 581113
Servicing 516013A
 Mounting bracket



233910

Replacing 581185
Servicing 516013B, -13C, -15
 Mounting bracket

Replacing DUCELLIER

Covers



131604

Servicing 7549, 7550A, 7586, 7596, 7597, 513008, 515094, 516006, 516007, 516038

Bracket mounting bushing kit



131609

Replacing 23055

Servicing 7522B,C, 7529A,C, 7532A,B,C,D,E, 7534A,B,C,D,E, 7556A



131612

Replacing 691222

Servicing 516006C, 516020A, 516023A,B, 516024, 516025, 516026, 516032, 516035, 516037, 516038, 516041, 516043A, 516044, 581007



131605 A

Servicing 7593, 516012, 515012, 516013

Bracket mounting bushing kit
Threaded M10



131610

Replacing 690640

Servicing 516013A,B,C, 516015A, 516016A,B, 516039A



131613

Replacing 690994

Servicing 512008E, 512010C



131611

Replacing 690699

Servicing 7575A,B,C,D, 7586B,C,D,E, 7590A,B,C,D, 515003A,B,C, 515007A, 515009A, 515010A, 515013A, 515014A, 515015A, 516006A, 516012A,B,C, 516014A, 516017A, 516021A



131614

Replacing 669481

Servicing 7527, 7530, 7541, 7549, 7550, 7551, 7557, 7558, 7564, 7576, 7577, 7578, 7591, 7595, 7596, 7597, 7599, 513001, 513008, 513009, 514002, 514004, 514005, 514006, 514007, 514008

Replacing DUCELLIER

Regulators



131808

Replacing 690467
Servicing 2516002A,B, 516003,
 516004A, 516005A



130017

Replacing 519004
 12 V.
 Electronic, single phase



130679

Replacing 8347C, 519001
 12 V.
 Electronic



132243

Replacing 691094
Servicing 516008B, 516009A,B



130606

Replacing 8410, 511005
Servicing 514002, 514003, 514007,
 516002, 516003, 516004, 516005,
 516012
 12 V.



131036

Replacing 581186
Servicing 514006A, B
 12 V.



130632

Replacing 8366, 519003
 12 V.
 Electronic, battery fitting

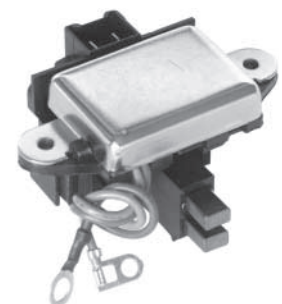

131222

Replacing 691292, 690686
Servicing 514011A, 514012A,
 516006A,B,C, 516007A,B, 516008A,B,
 516009A,B, 516013, 516017A,
 516020A,B, 516023A,B, 516024A
 12 V.

Replacing DUCELLIER



131281

Replacing 581215
Servicing 512008E, 512010C
 12 V.



131551

Replacing 691146
Servicing 516002, 516019, 516027
 12 V.

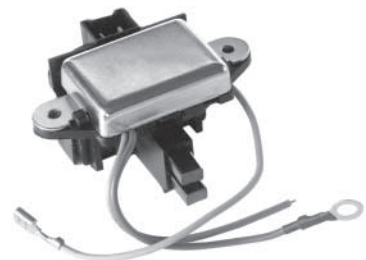

133132

Replacing 691191
Servicing 516035A, B
 12 V.



131498

Replacing 511011
Servicing 514013A, 516014A, 516021
 12 V.

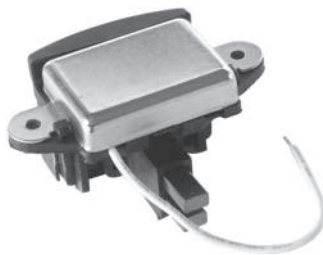

132038

Replacing 691303
Servicing 516040, 516041
 12 V.



131550

Replacing 581257
Servicing 514005, 514007, 514010
 12 V.



133029

For 9 diodes alternators
 W/ diag. terminal
 For UK marked
 12 V.

Replacing DUCELLIER

Rectifiers

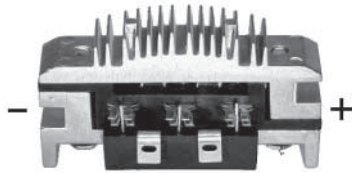

130633 HD
Replacing 581064
Servicing 7564, 7569, 7571, 7590, 7595, 7599, 513002, 513004, 513005, 513009, 513010, 513011, 513014, 514002, 514004, 514005, 514007
 W/ diode trio

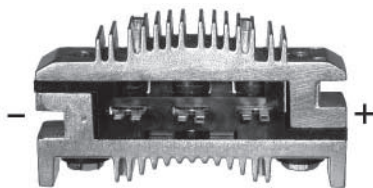

130634 HD
Replacing 581071
Servicing 7527, 7548, 7549, 7550

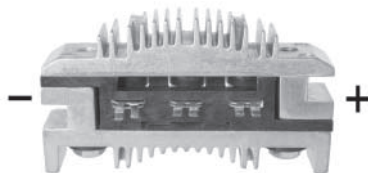

131560 HD
Replacing 581162
Servicing 7584E, 516013A,B,C, 516015A, 516016A,B, 516050A

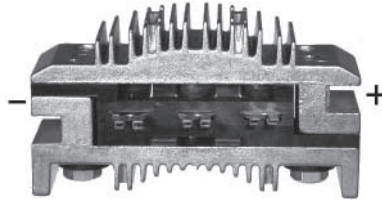

131561
Replacing 518559
Servicing 7580A,B,C, 7584B, 7593A, 515004A,B, 515005A,B, 515012A, 516008A,B,C, 516009A,B,C, 16030C,D,E, 516034A,B, 516042A,B,C, 516045A,B,C

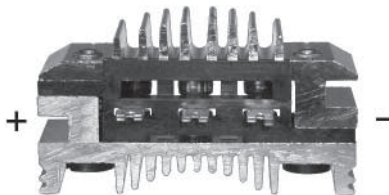

131562
Replacing 581163
Servicing 516007A,B,C,D, 516029A,B

Rectifier Parts



136301 Std pkg 5
 B+ terminal



136352 Std pkg 10
Servicing 7534, 7590
 Terminal M4 x 34 mm

Replacing DUCELLIER

Diode Trios



131692 Std pkg 5
For rectifier
400 V. 2 Amp.



131693 Std pkg 5 **A**
For rectifier w/ D+ connection
400 V. 2 Amp.

Slip Rings



130841 Std pkg 10
Replacing 34100328
Servicing 7545A
O.D. 36 mm, Shaft 17 mm, L. 22.5 mm



131816 Std pkg 5 **A**
Servicing I.C. alternators
O.D. 30 mm, Shaft 17 mm, L. 27.4 mm



132295 Std pkg 10 **A**
Servicing I.C. alternators
O.D. 30 mm, Shaft 17 mm, L. 28 mm



133350 Std pkg 5
Servicing 581110, Cargo 131959
O.D. 30 mm, Shaft 17 mm, L. 27 mm



132848 Std pkg 10 **A**
Servicing Cargo 131816, 132295,
133350
Insulator for slip ring

Replacing DUCELLIER

Brush Boxes

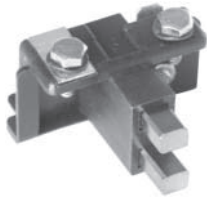

130698

Replacing 21176
Servicing 7526, 7527, 7528, 7529, 7530, 7551, 7556
 12 V. Complete w/ brushes



130699

Replacing 23267
Servicing 7522B, C, 7532A, B, C, 7534A, B, C
 12 V. Complete w/ brushes



130700

Replacing 608272
Servicing 7526, 7527, 7528, 7529, 7590
 12 V. Complete w/ brushes



130701

Replacing 611194
Servicing 7522AG, 7542AG
 12 V. Complete w/ brushes

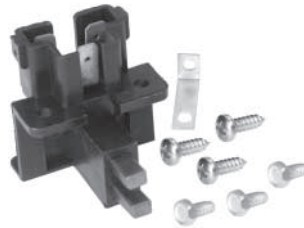

130935

Replacing 618306
Servicing 7564A, B, 7595A, B, 7599A, B
 12 V. Complete w/ brushes



130942

Replacing 581092
Servicing 7575D, 7585D, 7586E, 7590D, 513005E, 513011A, 513012A
 12 V. Complete w/ brushes

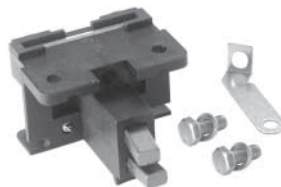

130943

Replacing 581223
Servicing 512008B,C,D, 512010A,B, 514001A, 514002A, 514003A, 514005B,C
 12 V. Complete w/ brushes

Brush Sets



UX67-68 2 Std pkg 10

Replacing 21177
 5.5 x 6.5 x 12.7 mm
 12 V.



UX69-70 2 Std pkg 10

Replacing 22315
 6.5 x 5.5 x 12.7 mm
 12 V.



UX71-72 2 Std pkg 10

5 x 4 x 8 mm
 12 V.



UX79-80 2 Std pkg 10

Replacing 612 430
 4.5 x 6 x 15 mm
 12 V.

Also see Pulley Survey
page 809

Replacing DUCCELLIER



UX82-83 2 Std pkg 10
Replacing 618 306
 4.5 x 6 x 15 mm
 12 V.



UX92 2 Std pkg 10
Replacing 581159
 4 x 7 x 15 mm
 12 V.

Fan & Pulleys



131842
Servicing 516038
 O.D. 56 mm, Bore 17 mm, W. 23.2 mm,
 5 grooves



UX84 2 Std pkg 10
Replacing 581 092
 4 x 7 x 15 mm
 12 V.



133936
Replacing 669244
Servicing 515005A, -B, 516009A, -B, -C,
 516029A, -B, 516030C, -D, -E, 7593A
 O.D. 64.5 mm, Bore 17 mm, W. 16.4 mm,
 Single



UX85 2 Std pkg 10
 4.5 x 6 x 15 mm
 12 V.



UX87-88 2 Std pkg 10
Replacing 581 111
 4 x 7 x 15 mm
 12 V.

Replacing DUCELLIER

Repair Kits



134114

Replacing 581077
Servicing 7534, 7590
 Terminal kit

Sundry Parts



130836 Std pkg 10
Replacing 23259
Servicing 7529A,C, 7532A,B,C, 7556A
 Fuse 30 Amp.



130837 Std pkg 10
Replacing 611745
Servicing 7540A,B,C, 7262A,B,C,D,
 7563A,B
 Fuse 30 Amp.



131691 Std pkg 10 **A**
Replacing 608336
 Fuse 25 Amp.



Replacing DUCELLIER

Generator Brush Sets



UX58 2 Std pkg 10
Replacing 21054
7 x 20 x 21 mm
12 V.

Generator Bushings



140068 Std pkg 10
Replacing 047403, 087880
17.05 x 21.05 x 20 mm

Replacing ELMOT

Rotors



134453

Replacing 346 300.0
Servicing A115-34B
 12 V. 34 Amp.
 L. 238.3 mm, O.D. 83.3 mm, Shaft 17 mm

Stators



130363

Replacing 903 100.1
Servicing A124N, A12M
 12 V. 42 Amp.
 O.D. 124.1 mm, I.D. 86.1 mm, W. 24.2 mm

Covers



133833

Replacing 343 480.0
Servicing A115-43



133829

Replacing 343 100.0, -F, -G
Servicing A115-45
 12 V. 45 Amp.
 O.D. 114.2 mm, I.D. 83.4 mm, W. 19 mm



133836

Replacing 346 480.1
Servicing A115-34B



133830

Replacing 341 100.0
Servicing A115-04, -34B
 12 V. 34 Amp.
 O.D. 113.6 mm, I.D. 83.1 mm, W. 19 mm

Replacing ELMOT

Regulators



131145

Replacing 685.000.0, 351.750.0
Servicing A115-43
 12 V.



133844

Replacing 684.000.0, 346.700.0
Servicing A115-34B
 12 V.

Rectifiers



130364

Replacing 903 440.0
Servicing A124N, A12M



133831

Replacing 343.600.5
Servicing A115-43



133835

Replacing 346.601.1, 346.600.5
Servicing A115-34B

Slip Rings



131817 A

Servicing A115-43
 O.D. 25 mm, Shaft 9 mm, L. 21.4 mm



133401 Std pkg 10 A

O.D. 32 mm, Shaft 17 mm, L. 22.3 mm
 W/ 1.8 mm copper

Replacing ELMOT

Brush Boxes



130703 A
Replacing 903 902.0
Servicing A124N, A12M
 12 V. Complete w/ brushes



133837
Replacing 346.460.0
Servicing A115-34B
 12 V. Complete w/ brushes



234930
Replacing 341.461.0
Servicing A115, A133
 W/o brushes
Brush set: Cargo 140161 or 140444

Brush Sets



140161 Std pkg 10 **A**
Servicing A115-43,
 4 x 7 x 20 mm
 12 V.



140444 Std pkg 10 **A**
Replacing 341 462.0
Servicing A115-43,
 4 x 7 x 20 mm
 12 V.



JX28-29 2 Std pkg 10
Servicing Polski Fiat, Polonez
 7 x 5 x 12.3 / 11.7 mm
 12 V.

Fan & Pulleys



132569
Replacing 903 915.0
Servicing A124N, A12M,
 O.D. 137 mm, Bore 15 mm
 Fan

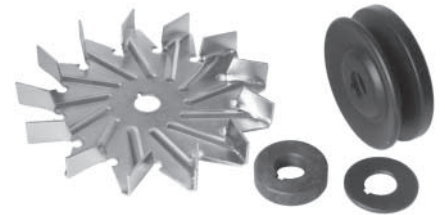

132592
Servicing A124N, A12M
 Fan: O.D. 137 mm
 Single pulley: O.D. 72.7 mm, Bore 15 mm,
 W. 20.6 mm
 Fan and pulley

Sundry Parts



132323 Std pkg 10 **A**
Replacing 153 018.80
Servicing A124N, A12M
 Connection

Replacing FEMSA

Covers



131491

Replacing 26431-1
Servicing Ford
Blue



137595

Replacing 32405-2, 9121 335 516
Servicing ALS12X-65, -77

Regulators



130610

Replacing RFH24-4
24 V.
Electronic



130611

Replacing 25169-4
Servicing ALP12N-1, -2, -12, ALS12N-53, -62, -63, -64, -72, ALT12N-1, -2, -3, -4, -6, -7, -8, -11, -12, -13, -14, -16, -17, -18, -19, -22, -25, -38, -39, -44, -45, ALZ24N-2
12 V.



130612

Replacing 28860-15
Servicing ALT12N-31
12 V.



130613

Replacing GRO12X-1, RFH12-11
12 V.
Electronic



130632

Replacing GRO12-4
12 V.
Electronic



131660

Replacing 28860-21
Servicing ALP12N-20, -24, ALS12-11, ALS12N-14, -24, -42, -55, -56, ALT12N-24, -32, -33, -35
12 V.

Replacing FEMSA



131684

Replacing 28860-8
Servicing ALP12NR-19, ALT12N-37, -38, -41
 12 V.



133134

Replacing 33544-2, 9190 330 604
Servicing ALP12X-17
 12 V.

Rectifiers



130364 HD

Replacing 19326-1
Servicing ALB40N68, -86



131685

Replacing 28860-4
Servicing ALS24-20, -22, ALS24N-5, -12, -15, -17, -18, -40, ALS24NX-2, -6, -13, -19, -58, -73
 24 V.



131563 HD

Replacing 28466-2, -3, -7, -11, -16
Servicing ALD12-13, -16, -20, -21, -24, -36, -37, -41, -46, -47, -54, -55, -58, -64, -66, ALF12-3, -4, -6, -13, -14, -21, -23, -24, ALG12-5, -7, -19, -20, -24



131686

Replacing 33543-1
Servicing ALS12X-26, -28, -65
 12 V.



131564 HD

Replacing 25945-1
Servicing ALB40N-88, -89, -90
 W/ diode trio

Replacing FEMSA



131694 HD

Replacing 28466-6, -18
Servicing ALB12-104, -117, ALB30X-92, ALB40-77, -83, -87, ALB40S-64, ALE12-10, -26, -31, ALE24-2, -5, -6, -12
 W/ diode trio



131695 HD

Replacing 25945-2, -3, -4, -8, -12, -13, -17
Servicing ALD12N-40, -60, -61, -62, ALG12N-9, -10, -11, -13, -14, -15, -23, -29, ALT12N-1, -2, -3, -4, -6, -7, -8, -11, -12
 W/ diode trio



136455 HD

Replacing 25945-9
Servicing ALS24N-5, -10, -12, -14, -15, -17, -18, -20, -22, -24, -40, -42, -55, -56, ALS24NX-2, -6, -13, -19, -73



136456 HD

Replacing 25945-10
Servicing ALD12-32, -33, ALS12N-53, -54, -62, -63, -64, ALT12N-38, -40

Brush Boxes

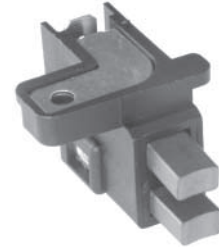

130702

Replacing 19310-1, -20, 30157-3
Servicing ALB12N-101, -102, -104, -114, -117, ALB30X-92, ALB40-35, -77, -83, -87, -88, -89, -90, ALB40N-88, ALB40S-64, ALD12-2, -3, -13, -16, -20
 12 V. Complete w/ brushes



131469

Replacing 19310-6, -9, -13, -26, -27
Servicing ALS12N-1, -25, -53, -54, -63, -64, ALP12N-1, -2, -12, ALT12N-1, -13, -14, -19
 12 V. Complete w/ brushes



132738

Replacing 19310-22
Servicing ALP12N-20
 12 V. Complete w/ brushes

Replacing FEMSA



133547

Replacing 19310-16

Servicing ALP12N-62, ALP12NR-19,
ALP12X-17, ALT12N-37
12 V. Complete w/ brushes

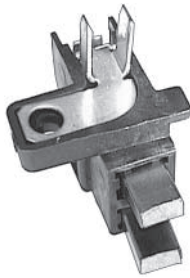

135858

Replacing 19310-21

Servicing ALP12N-24, ALS12N-10,
-14, -24, -42, -55, -56, ALT12N-18, -22
12 V. Complete w/ brushes



136651

Replacing 19310-28

Servicing ALS12X-26, -28, -65, -67, -76,
-77
12 V. Complete w/ brushes

Replacing FORD US

Rotors



136211

Servicing 3G series
12 V. 75/95 Amp.
L. 151.7 mm, O.D. 99.5 mm, Shaft 17 mm
Can also be used in 75/85/90 Amp. alternators
Shaft nut: Cargo 132346, 191657
Rotor coil: Cargo 233188



136212

Servicing 3G series
12 V. 130 Amp.
L. 154 mm, O.D. 111.3 mm, Shaft 17 mm
Can also be used in 115 Amp. alternators
Shaft nut: Cargo 132346, 191657
Rotor coil: Cargo 233189

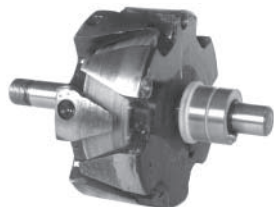

233181

Replacing E8DZ10335A
Servicing 1G series
12 V. 100 Amp.
L. 165 mm, O.D. 113 mm, Shaft 17 mm

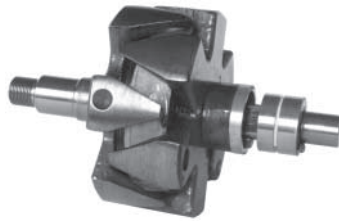

233182

Replacing E2HZ10335A, -B
Servicing 1G series Blue back truck
12 V. 90 Amp.
L. 187 mm, O.D. 113 mm, Shaft 22.35 mm



233183

Replacing E43Z10335A, -B, -C
Servicing 2G series
12 V. 75 Amp.
L. 156 mm, O.D. 90.5 mm, Shaft 17 mm



233184

Replacing E9FZ10335A
Servicing 2G series
12 V. 80 Amp.
L. 156 mm, O.D. 101 mm, Shaft 17 mm



233185

Servicing 4G series
12 V. 130 Amp.
L. 128.3 mm, O.D. 111.5 mm, Shaft 17 mm
Repair slip ring: Cargo 233192



233186

Replacing F8AU10335AA
Servicing 6G series
12 V. 130 Amp.
L. 152 mm, O.D. 111 mm, Shaft 17 mm

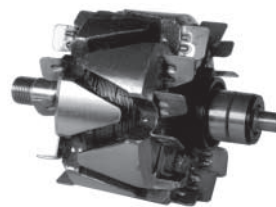

233187

Replacing F8WU10335BB
Servicing 6G series
12 V. 110 Amp.
L. 152 mm, O.D. 99.5 mm, Shaft 17 mm

Replacing FORD US



234344

Replacing C5AZ10335D
Servicing 1G series
 12 V. 65 Amp.
 L. 155 mm, O.D. 90.6 mm, Shaft 17 mm

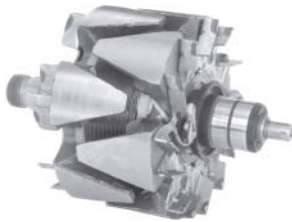

234621

Servicing 97MF10300AA, -AB, 98MF10300CA, -CB, -CC
 12 V. 70 Amp.
 L. 142.9 mm, O.D. 94.5 mm, Shaft 17 mm



Rotor Parts



233188

Servicing 3G series
 12 V. 95 Amp.
 Rotor coil
 Used in rotor: Cargo 136211



233189

Servicing 3G series
 12 V. 130 Amp.
 Rotor coil
 Used in rotor: Cargo 136212



132346 Std pkg 10 A

Servicing 3G series
 .668" - 20 x 15/16"
 Rotor shaft nut



191657 Std pkg 100

Servicing 4G series
 M16-1.5, W. 8 mm
 Spanner size 24 mm
 Rotor shaft nut



233190 Std pkg 5
Replacing E6AZ10370A
Servicing 1G-, 2G-, 3G series
 15.2 x 18 x 1.4 mm
 Retaining ring



233404

Servicing 3G series
 17 x 24 x 4.5 mm
 Spacer for rotor



Replacing FORD US

Stators



130518 Reman.
Replacing C6AZ10336A
Servicing 1G Series
 12 V. 61 Amp.
 O.D. 133.8 mm, I.D. 91.1 mm, W. 23 mm



136213
Servicing 3G series
 12 V. 95 Amp.
 O.D. 129 mm, I.D. 100 mm, W. 27.5 mm
 Can also be used in 75/85/90 Amp. alternators



230069
Servicing 6G series
 12 V. 105 Amp.
 O.D. 130 mm, I.D. 100 mm, W. 31 mm



131867 Reman.
Replacing D20Z10336A, GC311
Servicing 1G Series
 12 V. 70 Amp.
 O.D. 161.1 mm, I.D. 114.2 mm, W. 26.5 mm



136214
Servicing 3G-, 4G series
 12 V. 130 Amp.
 O.D. 142 mm, I.D. 112 mm, W. 29 mm
 Can also be used in 115 Amp. alternators



231532
Servicing 92AB10300JA, -JB
 12 V. 90 Amp.
 O.D. 126 mm, I.D. 100 mm, W. 20.2 mm



131868 Reman.
Replacing E6DZ10336A, GC385
Servicing 2G Series
 12 V. 75 Amp.
 O.D. 133.5 mm, I.D. 91 mm, W. 21.2 mm



136609
Replacing E8FZ10336A, GC394
Servicing 2G Series
 12 V. 80 Amp.
 O.D. 128 mm, I.D. 102 mm, W. 22 mm



233115
Replacing C9HZ10336A, D4HZ10336A
Servicing 1G series truck
 12 V. 90 Amp.
 O.D. 155 mm, I.D. 113 mm, W. 25 mm

Replacing FORD US



233116

Replacing F8SU10368AA
Servicing 4G-, 6G series
 12 V. 135 Amp.
 O.D. 142 mm, I.D. 112 mm, W. 28.5 mm

Brackets D.E.



230597

Servicing E83Z10346A
Bearing: Cargo 140411

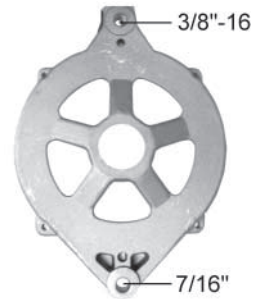

232308

Replacing D3VY10333A, GD323A
Servicing 1G series 70-100 Amp.
Bearing: Cargo 140087



231831

Servicing 93BB10300FD, -FE, -FF, -FG, 97BB10300BB
Bearing: Cargo 140093

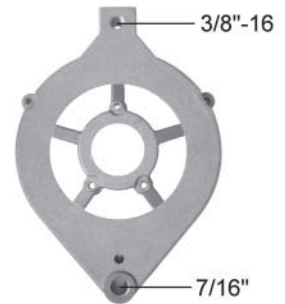

232313

Replacing C5AZ10333A, E6AZ10333A
Servicing 1G series 40-65 Amp, 2G series 40-75 Amp, D7AZ10346B, -C, D9BZ10346A, -B, D9VY10346A, -B, D9ZZ10346A, E1BZ10346B
Bearing: Cargo 140087

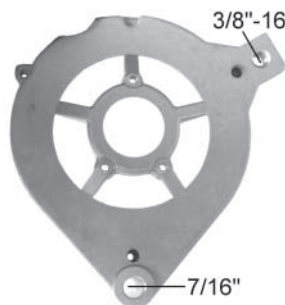

232307

Replacing E6DZ11333C, GD359, -B
Servicing 1G-, 2G series: E1BZ10346B, E1FZ10346A, -B, E2DZ10346A, E2GZ10346A, -B, E43Z10346A, -B, -C, -D, E53Z10346A, D63Z10346A, -B
Bearing: Cargo 140087

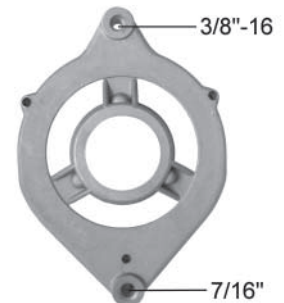

232314

Replacing D4HZ10333 A, GD351
Servicing 1G series 65-90 Amp, D2TF10300HA, D4HF10300BA, D4HF10346BA, D4HZ10346B, D4TF10300BA, D4TF10300CA
Bearing: Cargo 140279

Replacing FORD US



232315

Replacing E2HZ10333A, GD360
Servicing 1G series 75-90 Amp,
 E2HZ10346B, -C, -D, -E,
 F0HZ10346A, -B, -C, -D, -E, -F
Bearing: Cargo 140279



232318

Replacing E99Z10333A, GD377
Servicing 2G series 80 Amp,
 E9PZ10346B, F0PZ10346E
Bearing: Cargo 140087

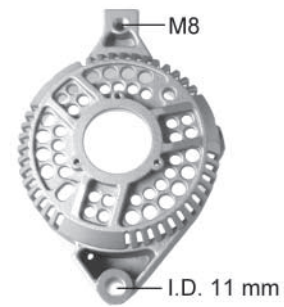

232322

Servicing 3G series 85-95 Amp,
 F0PU10346NC, F0VF10300AA,
 F0VU10300AA, -AB, -AC, F0VY10346A,
 -B, F1HT10300AA, -AB, -AC,
 F1PU10346DA, F1SU10300BA
Bearing: Cargo 140093

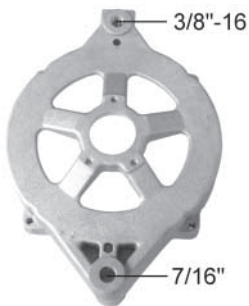

232316

Replacing E8OZ10333A, GD369
Servicing 1G series 100 Amp,
 E8PZ10346B, E9PZ10346E
Bearing: Cargo 140087



232319

Replacing E8FZ10333A, GD373
Servicing 2G series 80 Amp,
 E9PZ10346C, -D, F0PZ10346F
Bearing: Cargo 140087



232323

Servicing 3G series 95 Amp,
 F07F10300AA, F07U10300AA, -AB,
 -AC, F07U10346AC, F0PO10346BD,
 F17U10300AA, F1PU10346CA,
 F1TZ10346B, -C, F57U10300AA
Bearing: Cargo 140093



232317

Replacing F09Z10333A, GD380
Servicing 2G series 75-80 Amp,
 F09F10300AA, -BA, F0PF10346AA,
 -BA, F0PZ10346A, -B
Bearing: Cargo 140087

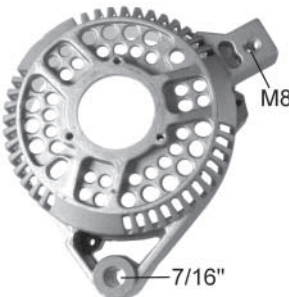

232320

Servicing 3G series 90-95 Amp,
 E9DF10300CA, E9DF10346AA,
 E9DZ10346B, E9PU10346AA,
 F0DF10300AA, F0DU10300AA, -AB,
 -AC, F0DU10346BC, F0DZ10346A, -D
Bearing: Cargo 140093

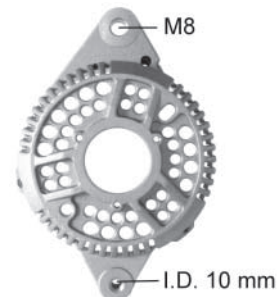

232324

Servicing 3G series 75-95 Amp,
 F0C10300AA, F0CU10300AA, -AB,
 -AC, -AD, F0CU10346AC,
 F0CZ10346A, -C, F0PU10346DD,
 F23U10300CA, -DA, F23U10346AD
Bearing: Cargo 140093

Replacing FORD US

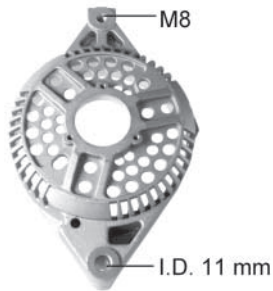

232325

Servicing 3G series 130 Amp, F0DF10300BA, F0DU10300BB, -BC, F0DZ10346B, -C, -E, F0PU10346AD, F1DU10300AD, -AE, F1DU10346AE, F1DZ10346A, -B, F1PU10346BE
Bearing: Cargo 140093



232328

Servicing 3G series 130 Amp, 97BB10300AC, F2PU10346AF, F2TU10300AF, F2TU10346AE, F37U10300AA, F3UU10300AE, -AF, F3UZ10346A, F5 UU10300AA, -BA
Bearing: Cargo 140093

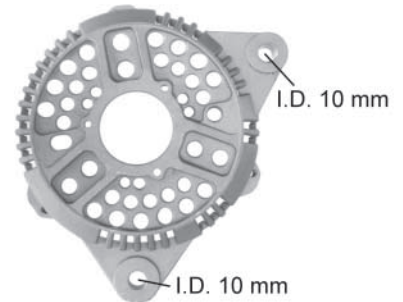

232363

Servicing 3G series 110-130 Amp, F4PZ10346C, F5RZ10346A, F6RZ10346AA, F8PZ10346CA
Bearing: Cargo 140093

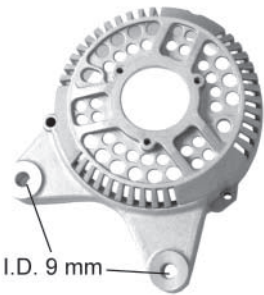

232326

Servicing 3G series 95 Amp, F1PU10346AC, F1VU10300BB, -BC, F1VU10346AD, F1VY10346A, -B, F3VU10300AA, F6PZ10346RA, F7UU10300AB
Bearing: Cargo 140093

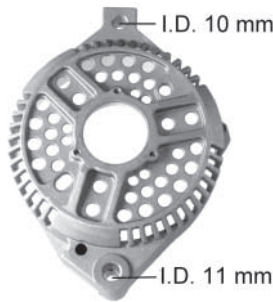

232329

Servicing 3G series 110-130 Amp, F3DU10300BB, F3DZ10346B, F3PU10346CA, F4DU10300BA, -DA, F4PU10346BA, F4PU10346DA, F4PZ10346B, -D, F4SU10300AB
Bearing: Cargo 140093

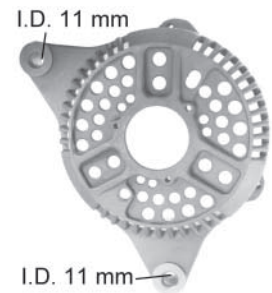

232364

Servicing 3G series 130 Amp, F5RU10346BC, F5RZ10346B, F6RZ10346BB, XS9Z10346AB
Bearing: Cargo 140093

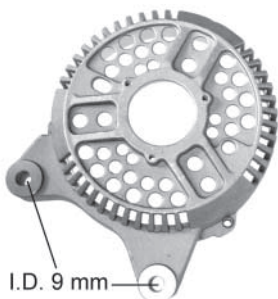

232327

Servicing 3G series 130 Amp, F3AU10300AC, -BA, -CA, F3AU10346AC, F3AZ10346A, F3PU10346AC, F5AU10300AA, F6AU10300AA, -AB, F6AZ10346AA
Bearing: Cargo 140093

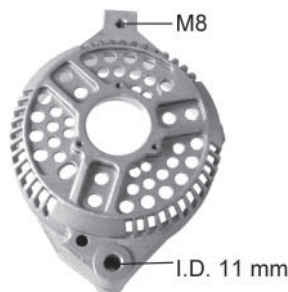

232330

Servicing 3G series 115 Amp, F3HT10300LA, F3HZ10346B, F3PU10346BA, F5HT10300BA, F5HZ10346E, F5PU10346EA
Bearing: Cargo 140093



232365

Servicing 4G series, F5OY10346A, F5OU10300FA, -FB, F6LU10300CA, F6LY10346A, F6OU10300AA, F6OY10346AA, F6ZU10300BB, -BC, F6ZZ10346B
Bearing: Cargo 140093

Replacing FORD US

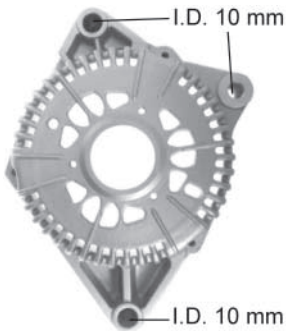

232366

Servicing 4G series,
F6DU10300BB, -BC, -BD,
F6DZ10346B, YF1Z10346E
Bearing: Cargo 140093

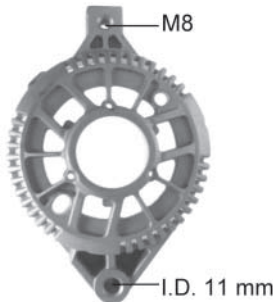

232369

Servicing 3G series 95 Amp,
F5PU10300GA, F5PZ10346GA,
F6HT10300LA, F6PU10346SA,
F6UZ10346SA
Bearing: Cargo 140783

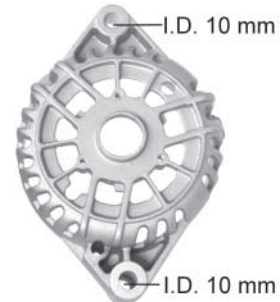

233106

Replacing XR3U10A351AA
Servicing 6G series: XF2U10300AB,
XF2Z10346AA, YF1U10300FA,
YF1Z10346FA
Bearing: Cargo 140093

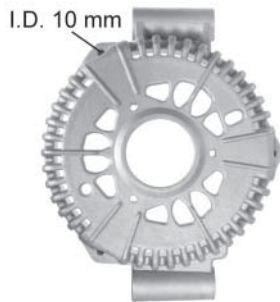

232367

Servicing 4G series,
F68U10300AD, F68Z10346AD,
F6DU10300DB, F6DZ10346D,
F77U10300AB, F77Z10346AB,
F78U10300AA, F78Z10346AA
Bearing: Cargo 140093



232370

Servicing 6G series,
F8AU10300AB, -AC, F8AZ10346AB
Bearing: Cargo 140093

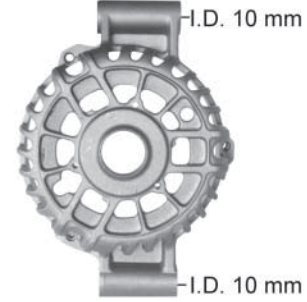

233107

Replacing F81U10A351AA
Servicing 6G series: F81U10300DB,
-DC, F81Z10346DA
Bearing: Cargo 140263

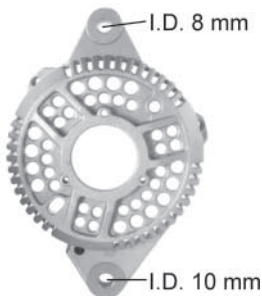

232368

Servicing 3G series 75 Amp,
F7CU10300CB, F7CZ10346CB,
F7PU10346CB
Bearing: Cargo 140093

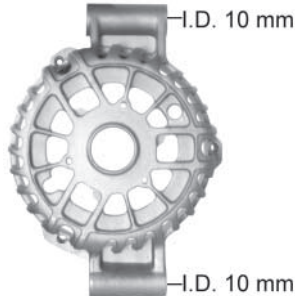

233105

Replacing F8CU10A351AA
Servicing 6G series: 98A10300FC,
98AZ10346FA, F81U10300CC, -EB, -GA,
F81Z10346CA, -EA, -GA
Bearing: Cargo 140093

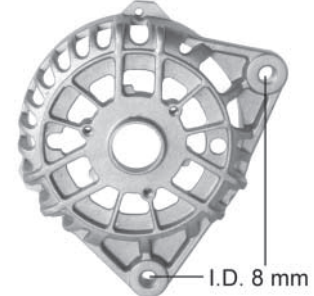

233108

Replacing F8RU10A351AA
Servicing 6G series: 98AZ10346EA,
98BB10300CC, F8RZ10346CC,
XS8Z10346BB, XS9110300BB
Bearing: Cargo 140093

Replacing FORD US



233798

Replacing F5RU10A351AA
Servicing 3G series: 96BB10300BA, -BB, -BE, F5RU10300BB, -BC, F6RU 10300 AA
Bearing: Cargo 140093



234742

Replacing XR8U10A351AB 
Servicing 6G series: XR8U10300CE, XR8Z10346CE, XW4U10300BA, -BB, XW4Z10346B
Bearing: Cargo 140093

Bracket S.R.E.

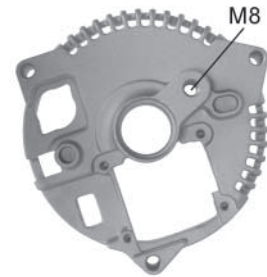

139325

Replacing F0DU10A349BB, -10A351BA
Servicing 93BB10300FD, -FE, -FF, -FG, 97BB10300BB
Bearing: Cargo 141002



234682

Replacing XF2U10A351AA
Servicing XF2U10300BC, -BD, -BE, XF2Z10346BA, XS7110300CA
Bearing: Cargo 140093

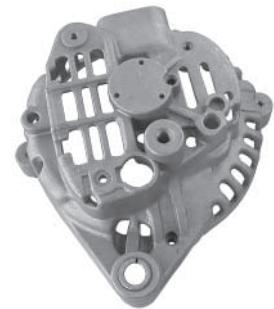

230598

Servicing E83Z10346A
Bearing: Cargo 140419



234684

Servicing XR3U10300AA, XR3Z10346SA
Bearing: Cargo 140093



232371

Replacing D7VZ10334A, GH314B
Servicing 1G series 70-100 Amp, D50F10300AA, -CA, D7EF10300BA, D70F10300AA, -CA, D8VF10300CA, D8ZF10300FA, D9AF10300CA
Needle bearing: Cargo 140120

Replacing FORD US



232372

Replacing D4HZ10334A, GH316
Servicing 1G series 65-90 Amp,
 D2TF10300HA, D4HF10300BA,
 D4HF10346B, D4TF10300BA, -CA,
 D4TF10346BA, D4TZ10346B
Needle bearing: Cargo 140120

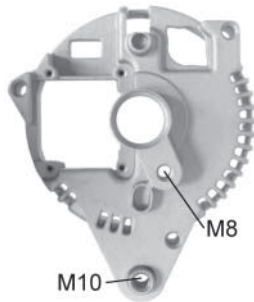

232375

Replacing F0CU10A349AB
Servicing 3G series 75-95 Amp,
 F0CF10300AA, F0CU10300AA, -AB,
 -AC, -AD, F0CU10346AC,
 F0CZ10346A, -C, F0PU10346DD
Bearing: Cargo 141002

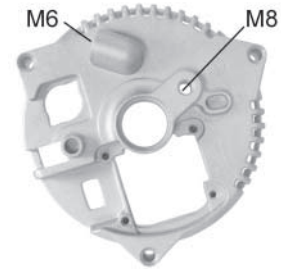

232378

Replacing F3AU10A349BA
Servicing 3G series 110-130 Amp,
 96BB10300AB, F3AU10300AC, -BA,
 -CA, F3AU10346AC, F3AZ10346A,
 F3DU10300BB, F3DZ10346B
Bearing: Cargo 141002



232373

Replacing E2HZ10334A, GH364
Servicing 1G series truck 75-90 Amp,
 E2HZ10346B, -C, -D, -E,
 F0HZ10346A, -B, -C, -D, -E, -F
Needle bearing: Cargo 140120

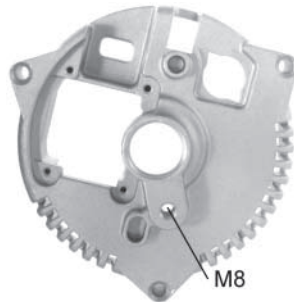

232376

Servicing 3G series 115-130 Amp,
 97BB10300 AC, F0DF10300BA,
 F0DU10300BB, -BC, F0DZ10346B, -C,
 -E, F0PU10346AD, F1DU10300AD,
 F1DU10300AE, F1DU10346AE
Bearing: Cargo 141002

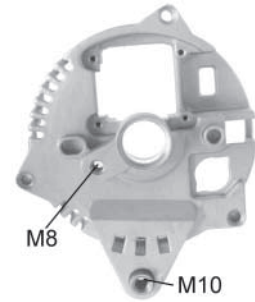

232379

Servicing 3G series 130 Amp,
 F4DU10300AA, F4OU10300CA,
 F4PU10346CA, F4PZ10346C
Bearing: Cargo 141002



232374

Replacing E6FZ10334A, E7ZZ10334A
Servicing 2G series,
 E43Z10346D, E53F10300EA, -HA,
 E53F10346BA, E63F10300CB,
 E69F10346AA, E69Z10346A
Needle bearing: Cargo 140120



232377

Servicing 3G series 95 Amp,
 F1PU10346AC, F1VU10300BB, -BC,
 F1VU10346AD, F1VY10346A, -B,
 F3VU10300AA, F6PZ10346RA,
 F7UU10300AB
Bearing: Cargo 141002

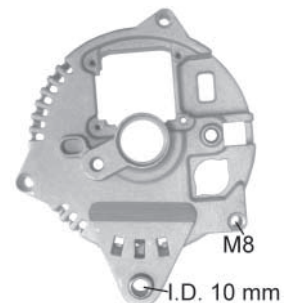

232380

Servicing 3G series 130 Amp,
 94BB10300AE, -AF, -AH,
 F4PU10300AA, F4PU10346AA,
 F5RZ10346A, F6RZ10346AA
Bearing: Cargo 141002

Replacing FORD US



232381

Servicing 4G series
Bearing: Cargo 140087



232382

Replacing XF2U10A349BA
Servicing 6G series: F8AU10300AB, -AC, F8AZ10346AB, XF2U10300BC, XF2Z10346BA
Bearing: Cargo 141026



233111

Replacing F8WU10A349BB
Servicing 6G series: 98AB10300FC, 98AZ10346FA, F81U10300BC, -CC, -DB, -DC, -EB, -GA, F81Z10346BA, -CA, -DA, -EA, -GA, XF2U10300AB
Bearing: Cargo 141026

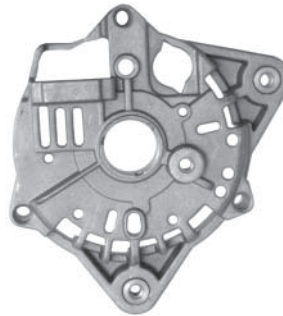

233112

Replacing F8RU10A349AB
Servicing 6G series: 98AZ10346EA, 98BB10300CC, F8RZ10346CC, XS8Z10346BB, XS9110300BB



233899

Servicing YS6110300BB, -BF
Bearing: Cargo 141071

Bracket Parts



232669 Std pkg 5
Servicing 3G series: 94BB10300AE, -AF, -AH, F4PU10300AA, F4PU10346AA, F5RZ10346A, F6RZ10346AA
10 x 15/24 x 20 mm
Mounting bushing, S.R.E.



233313

Servicing 3G series
M10 x 15.2/22.5 x 20 mm
Mounting bushing, S.R.E.



139265

Std pkg 10
Servicing 3G series
O.D. 30.4 mm
Expansion plug for S.R.E. Brackets



231763

Std pkg 5
Servicing 3G-, 6G series
O.D. 56 mm, I.D. 38 mm
Bearing plate

Replacing FORD US



232763

Replacing C7T210A355A
Servicing 1G series
 Bearing retainer, D.E. Bracket



234024

Servicing 1S7T10300BA, -BB, -DB, -DC
 O.D. 36.9 mm, I.D. 35 mm
 6202 Bearing cap

Covers

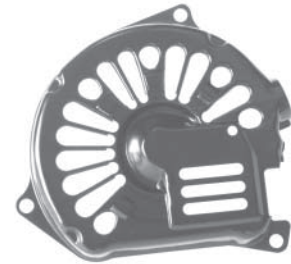

233308

Servicing 4G series: F5OY10346A, F68Z10346AD, D6DZ10346B, -D, F6LY10346A, F6OY10346AA, F6ZZ10346B, F77Z10346AB, F78Z10346AA, F8OZ10346CA S.R.E.



233309

Replacing D2OZ10A355A
Servicing 1G-, 2G series 40-65 Amp.
 Bearing retainer, D.E. Bracket



233409 Std pkg 10

Replacing 379201S
Servicing 1G-, 2G series
 10-24 x 5/8"
 Screw for bearing plate



233311

Servicing 4G series: F5OY10346A, F68Z10346AD, D6DZ10346B, -D, F6LY10346A, F6OY10346AA, F6ZZ10346B, F77Z10346AB, F78Z10346AA, F8OZ10346CA
 Bearing retainer, D.E. Bracket



234910

Servicing 3G-, 6G-series
 10-24 x 5/8", plain finish
 Screw for bearing plate

234772

Servicing 1S7T10300BA, -BB, -BC, -CB, -CC, -CD, -DB, -DC



233312

Servicing 3G, 6G series: F81U10300BC, -DB, -DC, F81Z10346BA, -DA
 O.D. 67 mm, I.D. 33 mm
 Bearing retainer, D.E. Bracket



Replacing FORD US

Regulators



130506

Replacing E2PZ10316A, GR540
Servicing Cargo 110237, 110238, 110239
 12 V.
 Short circuit protected



135854

Replacing F3AZ10316A, F3AZ10346A
Servicing 3G series: F3AU10300CA
 12 V.



138185

Replacing F5RZ10316A, F5RU10316BA
Servicing 3G series: 94BB10300AE, F4PU10300AA, F5RU10300BA, F5RU10346BC, F5RZ10346BC
 12 V.
 W/ Load response control

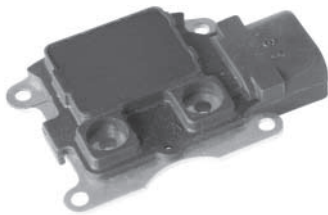

131907

Replacing E43Z10316A, GR784, -A, -B
Servicing 2G series
 12 V.
 With brush box Cargo 234645



136230

Replacing E9DF10316AA, F0DZ10316A
Servicing 3G series: F07F10300AA, F0CF10300AA, F0DF10300AA, -BA, F0DU10300BC, F0PU10346CA, -DA, F0VF10300AA, F13U10300CA
 12 V.



138663

Replacing F5OU10316A, GR815
Servicing 4G series: F6DU10300BB, F56DU10300DB, F5OU10300FA
 12 V.
 W/ Load response control
 Black housing

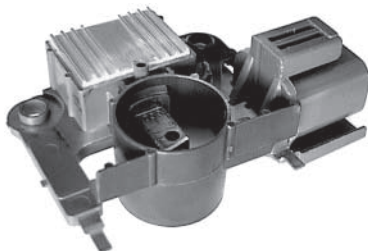

135030

Replacing E9PZ10316A, GRE796
Servicing E9DF10300B
 12 V.
 Terminals S-L

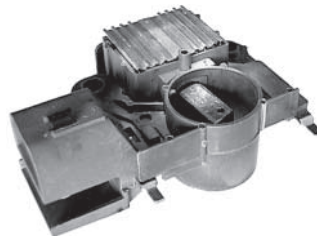

137748

Replacing E8PZ10316B, GRE793
Servicing E83F10300AA, -AB, -BA, E83210346A, E8DF10300AB, E8DZ10346A
 12 V.

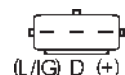

230065

Replacing F8WU10C359AB
Servicing 6G series: F81Z10346CA, -DA, -EA, -GA, F8AU10300AC, F8AZ10346AB, XR5Z10346AA
 12 V.

Replacing FORD US

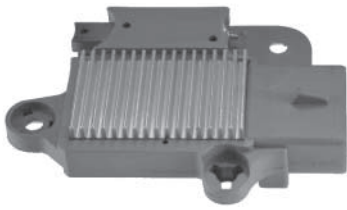

230066

Replacing F6DY10C316A, GR817
Servicing 4G series: F6LU10300CA, F6ZU10300BC, F77U10300AB
 12 V.
 Terminals I-S-A
 Grey Housing

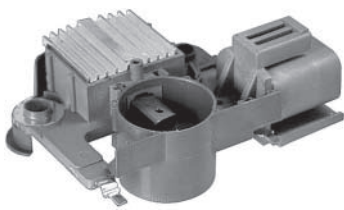

230262

Replacing E9PZ10316A, GRE804
Servicing E9DZ10300BB, -10346A
 12 V.
 Terminals I-A

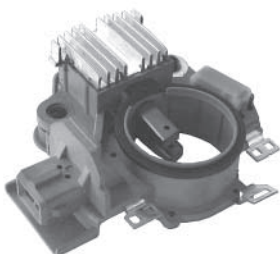

230985

Servicing 98VB10K359BA, -BB
 12 V.



232414

Replacing F1DZ10C359A, GR821
Servicing 3G series
 12 V.
 W/ brush box

Volt setting 14.5 V.



232415

Replacing F4ZU10316AA, -AC, GR814
Servicing 3G series
 12 V.
 6 sec. LRC

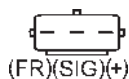

233232

Replacing XW4U10C359AB
Servicing 6G series: 1L8Z10346AB, 98AB10300FC, 98AZ10346EA, -FA, XF2U10300AB, -BC, XF2Z10346AA, -BA, XR8U10346AE, -CE, XR8Z10346AA, -CE
 12 V.



233775

Replacing XS7U10C359AC
Servicing 6G series: 98BB10300CC, X58Z10346BB
 12 V.
 7 sec. LRC



234164

Replacing C3TZ10316B, D3TZ10316AA, D4TZ10316A
 12 V.
 Terminals I-A-S-F
 Electronic



234165

Replacing E6DF10316AA
 12 V.
 Terminals I-A-S-F
 Compatible with 7 Amp. rotors
 Digital dash compatible, short circuit protected

Replacing FORD US

Volt setting 14.2 V.

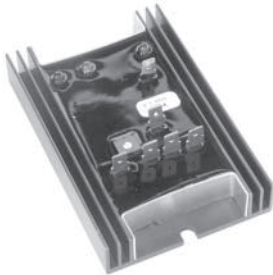

234324

Servicing EMV, Limo, Marine, Police Car, RV, Taxi....
12 V. Voyager
Regulation: **B-Circuit**
Adjustable Voltage (13-16 V.)
Voyager series regulator,
Over voltage protection,
Precise digital regulation,
Short circuit protected,
High current capability,
Ignition or light circuit activated with high side regulation.
Protected against loss of ground and under voltage.
LED's for easy troubleshooting
Fault detection indicators

Volt setting 27.5 V.

234325

As Cargo 234324 but 24 V.
Adjustable Voltage



234645

Servicing 2G series
12 V.
W/o brush box Cargo 131907

Regulator Parts



136222

Servicing 3G series
Repair harness



233316

Servicing 1G series
Repair harness
Regulator: Cargo 130506

Rectifiers



130517

Replacing C5AZ10304, GY1327
Servicing 1G series
For 40-65 Amp. alternators
B+ terminal 1/4"-28
Ground terminal 10-32



131421

Replacing D6AZ10304A, GY1306A
Servicing 1G series
For 40-65 Amp. alternators
B+ terminal 1/4"-28
Ground terminal 10-32



131422

Replacing D2OZ10304A, GY1026A
Servicing 1G series
For 70 Amp. alternators
B+ terminal 1/4"-20
Ground terminal 10-24

Replacing FORD US



131430

Replacing D3VY10304A, GY1302B
Servicing 1G series
 For 70-100 Amp. alternators
 B+ terminal 1/4"-20
 Ground terminal 10-24

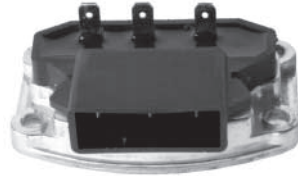

137048 HD

Replacing E43Z10304A, E6DZ10304, -A
Servicing 2G series
 6 - 50 Amp. diodes
 For 70-90 Amp. alternators



230870

Servicing 6G series
 135 Amp.
 O.D. 149 mm, 8 - 50 Amp. diodes
 B+ terminal M6
 For 2 stator leads/phase



136209

Replacing F5AZ10304BA
Servicing 3G series
 O.D. 133 mm
 For 75-95 Amp. alternators



139668

Servicing 4G series
 130 Amp. IR/IF Alternators
 O.D. 149 mm
 8 - 50 Amp. diodes



233207

Servicing 6G series: XW4U10300BA,
 XW4Z10346B, -BA, GL450
 105 Amp.
 O.D. 133 mm
 8 - 70 Amp. diodes
 For 1 stator lead/phase



136210

Replacing F5AZ10304AA
Servicing 3G series
 O.D. 146 mm
 8 - 50 Amp. diodes
 For 115-130 Amp. alternators



230842

Replacing F8WU10A336AA1P
Servicing 6G series
 105 Amp.
 O.D. 136 mm, 8 - 50 Amp. diodes
 B+ terminal M6
 For 2 stator leads/phase



233208

Servicing 6G series: 98AZ10346EA,
 98BB10300CC, F8RZ10346CC
 XS8Z10346BB, XS9110300BB
 105 Amp.
 O.D. 136 mm, 8 - 50 Amp. diodes
 For 2 stator leads/phase

Replacing FORD US

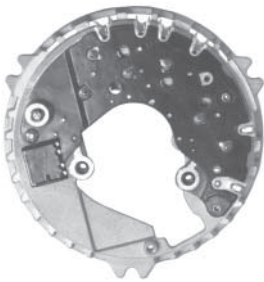

233209

Servicing 6G series: 1L8Z10346CB, WR2A10300AC, XS8Z10346AA, YF1Z10346FA
105 Amp.
O.D. 136 mm, 6 - 50 Amp. diodes
For 1 stator lead/phase

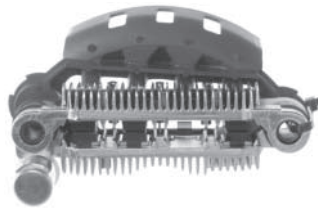

134297

Replacing E8PZ10304B
Servicing E83F10300AA, -AB, -BA, E83Z10346A
6 diodes
W/ diode trio and capacitor
B+ terminal M6



135252

Replacing E9PZ10304B
Servicing E9SF10300DA, E9SF10300BA
W/ diode trio and capacitor
B+ terminal M6

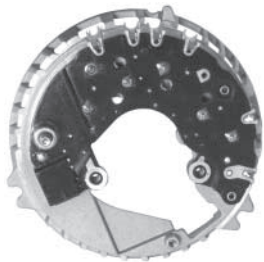

233210

Servicing 6G series: 1L8Z10346AB
105 Amp.
O.D. 136 mm
6 - 50 Amp. diodes
For 1 stator lead/phase

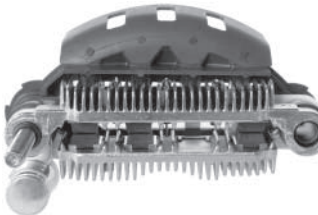

233511

Replacing E8PZ10340A
Servicing E8SF10300AA, -10346A
6 diodes
W/ diode trio
B+ terminal M6 x 23 mm



231079

Servicing 98VB10K399BA, -BB
B+ terminal M8 x 28 mm



233237

Replacing D4HZ10304A, D4TZ10304A
Servicing 1G series 65/90 Amp.

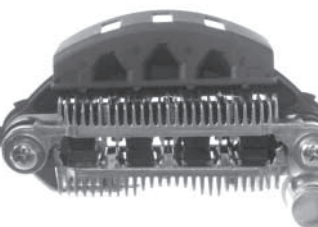

233746

Replacing E9PZ10304A
Servicing E9DF10300BB, F02U10300AA, F02Z10346A
8 diodes
W/ diode trio



233518

Servicing F3LU10300BA, -BB, -BC, F3LY10346A
6 diodes
W/ diode trio and capacitor
B+ terminal M5

Replacing FORD US



235019

Servicing 1S7T10300BA, -BB, -BC, -DB, -DC
W/ 8 avalanche diodes (50 Amp.)
B+ terminal M6

Rectifier Parts



232772 Std pkg 5
Servicing 2G series
Repair harness for rectifier



233292
Servicing 1G series
1/4"-20, L.15/16" mm
B+ Terminal



232775 Std pkg 5
Servicing 3G series
Repair plug for rectifier



233285
Servicing 6G series
M6-1, L. 29.5 mm
B+ terminal



233290
Servicing 3G series
M6-1, L. 36.5 mm
B+ terminal

Replacing FORD US

Slip Rings



133921 Std pkg 10
Servicing 1G series
 O.D. 31.75 mm, Shaft 17.5 mm, L. 20.5 mm



133922 Std pkg 10
Servicing 1G series
 O.D. 31.8 mm, Shaft 17.5 mm, L. 26.7 mm



136305 Std pkg 5
Servicing 3G series
 O.D. 26.85 mm, Shaft 13.38 mm, L. 34.7 mm



233191 Std pkg 5
Servicing 2G series
 O.D. 31.8 mm, Shaft 17.3 mm, L. 33.6 mm



233937 Std pkg 5
Servicing 4G series
 O.D. 16 mm, I.D. 6 mm, LL. 34 mm
Repair slip ring: Cargo 233192



233938 Std pkg 5
Replacing F8WU10328BA
Servicing 6G series
 O.D. 27 mm, I.D. 13.4 mm, LL. 30 mm



233192 Std pkg 5
Servicing 4G series
 Repair slip ring

Brush Boxes



131427
Replacing GB107
Servicing 1G series
 12 V. 55/61 Amp. Complete w/ brushes

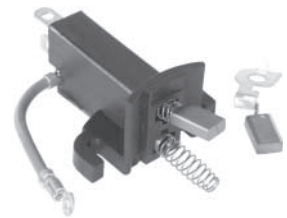

131428
Replacing D2OZ10347B
Servicing 1G series
 12 V. 70/90 Amp. Complete w/ brushes



131917
Replacing E43Z10320A
Servicing 2G series
 12 V. Complete w/ brushes
 I.C. alternators



136216
Replacing F1DZ10347A
Servicing 3G series
 12 V. Complete w/ brushes

Replacing FORD US



233211
Replacing D4HZ10B363A
Servicing 1G series: 65-90 Amp. trucks
 12 V. Complete w/ brushes



233212
Replacing D0AZ10B363A
Servicing 1G series: 65-90 Amp. trucks
 12 V. Complete w/ brushes



233213
Replacing E6HZ10B363A
Servicing 1G series: 75-90 Amp.
 Blue back truck
 12 V. Complete w/ brushes



233997
Servicing 1S7T10300BA, -BB, -DB, -DC
 12 V.
 W/o springs and brushes

Brush Box Parts



233293 Std pkg 10
Servicing 1G-, 2G-, 3G series
 L. 40.5 mm, O.D. 6.3 mm
 Brush spring



233294
Servicing 4G series
 L. 39.5 mm, O.D. 4.7 mm
 Brush spring



234734
Servicing 6G series
 L. 50.8 mm, O.D. 5.9 mm
 Brush spring

Brush Sets



140191
Replacing D2OF10A367BB
Servicing 1G series
 4 x 7.5 x 12.5 mm, LL. 15/36 mm
 12 V. 70/90 Amp.



141171
Servicing 2G series
 12 V.
 4 x 7.5 x 12 mm, LL. 39 mm



141172
Replacing D4HZ10347B
Servicing 1G series
 12 V.
 4.5 x 6.5 x 16 mm, LL. 28 mm



141173
Replacing E6HZ10347A
Servicing 1G series
 12 V.
 4 x 7.5 x 18.5 mm, LL. 31 mm

Replacing FORD US

Also see Bearing Chapter page 821



141174

Servicing 3G series: 1st production
12 V.
4 x 7.5 x 18 mm, LL. 29 mm
W/o epoxied lead



141229

Servicing 6G series
12 V.
5 x 8 x 17 mm, LL. 38 mm

Special Bearings



140588 Std pkg 5 **A**
Replacing SC0081LHIA
10/27 x 14 mm
W/ 2 teflon tolerance rings
S.R.E.



141175

Servicing 3G series: 2nd production
12 V.
4 x 7.5 x 18 mm, LL. 62 mm



142042

Servicing 1S7T10300BA, -BB, -BC, -CB, -CC, -CD, -DB, -DC, -DD, 2S6T10300AA, -FA, 2T1U10300AF, -AG, CA, -CB, 3S6T10300AA, TC1010300EA
4.5 x 8.2 x 12 mm

140783 Std pkg 6
Servicing 3G series
17/47 x 24 mm
D.E.



141176

Servicing 4G series
12 V.
4 x 7.5 x 15 mm, LL. 31 mm



FX42 2 Std pkg 10

Replacing C6VY10347A
Servicing 1G series
5 x 6.5 x 12.5 mm, LL. 25 mm
12 V. 61 Amp.

141002

Servicing 3G series
10/26 x 8 mm
W/ 2 teflon tolerance rings
S.R.E.



141203

Replacing D0AZ10347B, GB120A
Servicing 1G series
12 V.
4.5 x 6.5 x 12.5 mm, LL. 30 mm

141026

Servicing 6G series
10/27 x 11 mm
S.R.E.



Also see Bearing Chapter
and Pulley Survey

Replacing FORD US



141107

Replacing F50U10A304AA
Servicing 4G series
17/40 x 12 mm
W/ 2 teflon tolerance rings

Needle Bearings



140120 Std pkg 10 A

Replacing D2OZ10A304A
Servicing D2TZ., D5AZ., D3VY..
17/23.8 x 17.4 mm

Fan & Pulleys



233113

Replacing D9ZZ10A310A, E5SZ10A310A
Servicing 1G series
O.D. 136 mm, Bore 17 mm
Fan



133951

Replacing C5AZ10344L
O.D. 69.1 mm, Bore 17 mm, W. 38 mm,
Double



136215

Replacing F1DZ10344A, F1DU10A352AA
Servicing 3G series: F1DU10300AD,
-AE, F23U10300CA, -DA
O.D. 56.7 mm, Bore 17 mm, W. 32.4 mm,
5 grooves



139862

Servicing 93BB10300FD, -FE, -FF, -FG,
97BB10300BB
O.D. 59 mm, Bore 17 mm, W. 27.4 mm,
5 grooves

Replacing FORD US

Also see Pulley Survey page 809



230308

Replacing 3395459
Servicing Ford, Mazda
 O.D. 59.7 mm, Bore 17 mm, W. 36.5 mm,
 6 grooves, w/ Free wheel
Pulley tool: Cargo 210843



231332

Replacing FOCF10A352AA, GP667
Servicing 3G series
 O.D. 68.2 mm, Bore 17 mm, W. 31.8 mm,
 6 grooves



232121

Replacing E3TF10A352AA, E9TF10A352AA
Servicing 1G-, 2G series
 O.D. 84.9 mm, Bore 17 mm, W. 41.9 mm,
 Double, A+B-type belt



230534

Servicing E8DF10300AB, E8DZ10346A,
 E83F10300AA, -AB, -BA, E8SF10300AA,
 E8SZ10346A
 O.D. 54.1 mm, Bore 15 mm, W. 33 mm,
 6 grooves



232083

Replacing C5TF10A352JS, C5TZ10344J
Servicing 1G-, 2G series
 O.D. 81.3 mm, Bore 17 mm, W. 40.7 mm,
 Double, B-type belt



232122

Replacing F13U10A352AA, F13Z10344A
Servicing 3G series
 O.D. 75.7 mm, Bore 17 mm, W. 34.2 mm,
 Single



230535

Replacing C5AZ10344K, C9AF10A352B
Servicing 2G series
 O.D. 65.3 mm, Bore 17 mm, W. 22.2 mm,
 Single



232119

Replacing D3JL10130D1
Servicing 1G series
 O.D. 85.1 mm, Bore 17 mm, W. 26.6 mm,
 Single, B-type belt



232123

Replacing F2UU10A352AA, F2UZ10344A
Servicing 3G series
 O.D. 71.8 mm, Bore 17 mm, W. 39 mm,
 Double, A+B-type belt



230536

Replacing C5TF10A352K2, C9AF10A352C
Servicing 1G-, 2G series
 O.D. 65.5 mm, Bore 17 mm, W. 38.1 mm,
 Double



232120

Replacing E43F10A352AA, E53F10A352AA
Servicing 1G-, 2G series
 O.D. 66.6 mm, Bore 17 mm, W. 35.6 mm,
 Double



232124

Replacing F1HU10A352AB, F1HZ10344A
Servicing 3G series
 O.D. 75.2 mm, Bore 17 mm, W. 39.7 mm,
 Double, B-type belt

Also see Pulley Survey
page 809

Replacing FORD US



232125

Replacing E1EF10A352EA, -EB

Servicing 1G-, 2G series

O.D. 48.5 mm, Bore 17 mm, W. 31.7 mm,
5 grooves



232129

Replacing E8DZ10344B, E09F10A352AA

Servicing 1G-, 2G series

O.D. 61.7 mm, Bore 17 mm, W. 31.9 mm,
6 grooves



232133

Replacing F5UZ10344A, GP707

Servicing 3G series

O.D. 64.1 mm, Bore 17 mm, W. 35.6 mm,
7 grooves



232126

Replacing D9ZF10A352AA, E6SF10A352BA

Servicing 1G-, 2G series

O.D. 48.8 mm, Bore 17 mm, W. 31 mm,
6 grooves



232130

Replacing F1VU10A352AA, F1VY10344A

Servicing 3G series

O.D. 56.4 mm, Bore 17 mm, W. 36.8 mm,
7 grooves



232134

Replacing F5OU10A352DA, -FA

Servicing 4G series

O.D. 59 mm, Bore 17 mm, W. 27.7 mm,
6 grooves



232127

Replacing E9DF10A352AA, E9DZ10344A

Servicing 3G series

O.D. 55.2 mm, Bore 17 mm, W. 32.7 mm,
6 grooves



232131

Replacing F3HU10A352AB, F3HZ10344A

Servicing 3G series

O.D. 67.3 mm, Bore 17 mm, W. 45.6 mm,
8 grooves



232135

Replacing F5OZ10344E, GP714A

Servicing 4G series

O.D. 62.6 mm, Bore 17 mm, W. 27.9 mm,
6 grooves



232128

Replacing E9DF10A352GA, E7DZ10344A

Servicing 1G series

O.D. 58 mm, Bore 17 mm, W. 30.1 mm,
4 grooves



232132

Replacing F5UU10A352CA, F5UZ10344C

Servicing 3G-, 6G series

O.D. 62.6 mm, Bore 17 mm, W. 39.3 mm,
8 grooves



232136

Replacing F5TU10A352AA, F5TZ10344AA

Servicing 3G series

O.D. 66.8 mm, Bore 17 mm, W. 34.4 mm,
8 grooves

Replacing FORD US

Also see Pulley Survey page 809



232137

Replacing F65U10A352AA, F65Z10344AA
Servicing 3G series
 O.D. 57.9 mm, Bore 17 mm, W. 39.4 mm,
 8 grooves



232138

Replacing F81U10A352CA
Servicing 6G series
 O.D. 68.2 mm, Bore 17 mm, W. 39.3 mm,
 8 grooves



232139

Replacing F81U10A352BA
Servicing 6G series
 O.D. 64.1 mm, Bore 17 mm, W. 36.4 mm
 8 grooves



232140

Replacing F7RZ10344AA
Servicing 3G-, 6G series
 O.D. 48.2 mm, Bore 17 mm, W. 33.1 mm,
 6 grooves



232141

Replacing C7TF10A352A, C7TZ10344A
Servicing 1G series
 O.D. 84.4 mm, Bore 22.35 mm (0.880"),
 W. 41.8 mm,
 Double, B-type belt



232142

Replacing C7TF10A352B, C7TZ10344B
Servicing 1G series
 O.D. 77.8 mm, Bore 22.35 mm (0.880"),
 W. 39 mm
 Double



234401

Servicing 1S7T10300CB, -CC, -CD,
 F-232854.03
 O.D. 53.7 mm, Bore 17 mm, W. 35.8 mm,
 6 grooves, w/ Free wheel
Pulley tool: Cargo 210843



235157

Replacing YC1U10352BA
Servicing YC1U10300DA, -DB, -EA
 O.D. 61 mm, Bore 17 mm, W. 77 mm,
 7 grooves, w/ Free wheel
Pulley tool: Cargo 230843

Fan & Pulley Parts



133945 Std pkg 10 A

Replacing C5AZ10A344B
 O.D. 22.2 mm, Bore 17 mm, Th. 5.0 mm
 Spacer



133948 Std pkg 10 A

Replacing D2OZ10A344A
 O.D. 22.2 mm, Bore 17 mm, Th. 10.0 mm
 Spacer



233314

Replacing D0AZ10A344A, GY974
Servicing 1G series
 O.D. 32 mm, Bore 22.23 mm, Th. 4 mm
 Spacer



233315

Replacing C5AZ10A344B
Servicing 3G series
 O.D. 25.4 mm, Bore 17 mm, Th. 3.9 mm
 Spacer

Replacing FORD US



235022

Servicing 93BB10300FD, -FE, -FF, -FG, 97BB10300BB, -BC, -BD, -DB
 O.D. 24.3 mm, Bore 17 mm, Th. 4.3 mm
 Spacer

Repair Kits



232777

Include 131907 regulator, 137048 rectifier, 140087 bearing, 140120 needle bearing, 232772 repair harness, 232776 dielectric grease, FX42 2 brush set
Servicing 2G series

Sundry Parts



131423

Replacing C6AZ18827A
 12 V. 55 - 61 Amp. 5 mf.
 Capacitor



136217

Replacing F81U10329AA
Servicing 3G-, 6G series
 M6-1, L. 61 mm
 Red colour
 B+ terminal
Cap: Cargo 136219



136316

Std pkg 5
Replacing E8PZ10K330A
 B+ terminal



230067

Servicing 6G series
 M6-1, L. 61 mm
 Black
 B+ terminal
Cap: Cargo 136219

Replacing FORD US



230068
Replacing F8RU10329BA
Servicing 6G series
 M6-1, L. 63 mm
 Grey
 B+ terminal
Cap: Cargo 136219



233289
Servicing 1G series 40/65 Amp.
 10-32 x L. 1 1/2", twist lock
 Terminal, stator



136220 Std pkg 5
Servicing 3G series
 I.D. 7 mm
 Insulator B+ terminal



232174
Servicing 3G-, 6G series: 94BB10300AE,
 -AF, -AH, 97BB10300AC,
 F4PU10300AA, F4PU10346AA
 M6-1 x 63 mm
 White
 B+ terminal
Cap: Cargo 136219



233291
Servicing 1G series
 10-24 x L. 29/32"
 Terminal, ground



136221 Std pkg 5
Replacing F1DZ10329A
Servicing 3G series
 I.D. 12.6 mm
 Insulator B+ terminal



233286 Std pkg 10
Servicing 1G series 40/65 Amp.
 10-32 x L. 3/4"
 Terminal, field



136218 Std pkg 10
Replacing F1DZ10563A
Servicing 3G series
 Cap regulator terminal



230070 Std pkg 5
Servicing 6G series
 Red
 Insulator B+ terminal



233288
Servicing 1G series 75/90 Amp.
 Blue back truck
 10-24 x L. 1 3/4"
 Terminal, stator



136219
Servicing 3G-, 6G series
 O.D. 28 mm
 Cap, B+ terminal
*Used w/ B+ terminal: Cargo 136217,
 230067, 230068, 232174*



233282 Std pkg 5
Servicing 3G series 75/90 Amp.
 Used w/ 133 mm rectifier
 Stator leads
 Insulator

Replacing FORD US



233283 Std pkg 5
Servicing 3G series 115/130 Amp.
 Used w/ 146 mm rectifier
 Stator leads
 Insulator



230071 Std pkg 5
Servicing 6G series
 O.D. 29 mm, I.D. 27 mm, L. 16 mm
 Tolerance ring
 Cover: *Cargo 230072*



232644 Std pkg 10
Servicing 4G series
 M6-1 x 41 mm
 Thru bolt



233284 Std pkg 5
Servicing 3G series 75/130 Amp.
 Stator leads
 Insulator



230072 Std pkg 5
Servicing 6G series
 O.D. 39 mm
 Cover for S.R.E. Bearing
 Use w/ *Cargo 230071*



232773 Std pkg 5
Servicing 3G series
 Repair harness for stator terminal



233295
Servicing 6G series 105 Amp.
 Stator leads
 Insulator



230421 Std pkg 10
Replacing 378466-S100
Servicing 2G series
 10-24 x 2 1/8"
 Thru bolt



232774
Servicing 1G series
 Repair harness for brush holder



233296
Servicing 6G series 135 Amp.
 Stator leads
 Insulator



232643 Std pkg 100
Replacing N805910-S101
Servicing 3G-, 6G series
 M6-1 x 71 mm
 Thru bolt



233287
Servicing 3G-, 6G series
 0.68 mf.
 Condenser

Replacing FORD US



234478 Std pkg 10

Servicing 96BB10300BA, -BB, -BE,
F5RU10300BB, -BC, F6RU10300AA
M6 x 13.5 mm
B+ nut

Also see Pulley Survey
page 809

Replacing FORD US

Generator Fan & Pulleys



232143

Replacing 9N10130B

Servicing Ford tractors

O.D. 94.7 mm, Bore 15 mm, W. 24.1 mm,
Single, C-type belt



232144

Replacing 8N10130

Servicing Ford tractors

O.D. 93.4 mm, Bore 17 mm, W. 27.7 mm,
Single, C-type belt



Replacing FORD / VISTEON

Stators



234815



Servicing 1S7T10300BA, -BB, -BC, -CB, -CC, -CD, -DC
12 V. 90 Amp.
O.D. 128.4 mm, I.D. 98.3 mm, W. 32.5 mm

Brackets D.E.



234740



Servicing 1S7T10300BA, -BB, -BC, -CB, -CC, -CD, -DB, -DC
Bearing: Cargo 140093

Brackets S.R.E.



234707



Servicing 1S7T10300CB, -CC, -CD
Bearing: Cargo 140084

Replacing FORD / VISTEON

Bracket Parts



234910

Servicing 3G-, 6G-series
10-24 x 5/8", plain finish
Screw for bearing plate



Covers



235213

Replacing 86AB10A398BA
Servicing 86AB10300AB
Heat shield



Brush Box

238956

Servicing 1S7T10300 BA, -BB, -BC, -CB, -CC, -CD, -DB, -DC, -DD, 2S6T10300 AA, -FA, 2T1U10300 AF, -AG, -CA, -CB, 3S6T10300 AA, YC1U10300 EA
12 V.
Complete w/ brushes



Replacing FORD / VISTEON

Also see Pulley Survey

Brush Box Parts



234734

Servicing 6G series
L. 50.8 mm, O.D. 5.9 mm
Brush spring



234804

Servicing 1S7T10300BA, -BB, -BC, -DB, -DC 
L. 33.7 mm, O.D. 5.2 mm
Brush spring

Brush Sets



141229

Servicing 6G series
12 V.
5 x 8 x 17 mm, LL. 38 mm

Fan & Pulleys



234626

Servicing 1S7T10300BB, -BC, -DC, DB 
O.D. 53.4 mm, Bore 17 mm, W. 29 mm,
6 grooves



235312

Replacing YF1U10A352AA, GP736 
Servicing 4G series: 2F1U10300BA, -BB, 2F1Z10346BA, YF1U10300EA, -EB, YF1Z10346E
O.D. 75 mm, Bore 17 mm, W. 26.5 mm,
6 grooves

Replacing FORD / VISTEON

Repair Kits

234513

Servicing 1S7T10300BA, -BB, -BC, -CB, -CC, -CD, -DB, -DC, 2S6T10300AA, 3S6T10300AA
Terminal kit

Sundry Parts



234511

Servicing 1S7T10300BA, -BB, -BC, -CB, -CC, -CD, -DB, -DC
M5 x 114 mm
Thru bolt



234512

Servicing 1S7T10300BA, -BB, -BC, -CB, -CC, -CD, -DB, -DC, 2S6T10300AA, 3S6T10300AA
Cap for brush holder



234614

Servicing 1S7T10300BA, -BB, -BC, -CB, -CC, -CD, -DB, -DC, 2S6T10300AA, 3S6T10300AA
M5 x 28.3 mm, threaded 12.5 mm
Screw



234716

Servicing 1S7T10300BA, -BB, -BC, -CB, -CC, -CD, -DB, -DC
O.D. 6.8 mm, I.D. 5.3 mm, W. 12.3 mm
Insulator



234725

Servicing 1S7T10300BA, -BB, -BC, -CB, -CC, -CD, -DB, -DC
Insulator



234726

Servicing 1S7T10300BB, -BC, -CB, -CC, -CD, -DC
O.D. 8.5 mm, I.D. 3.4 mm, W. 3.7 mm
Insulator



234883

Servicing 1S7T10300BA, -BB, -BC, -CB, -CC, -CD, -DB, -DC
O.D. 14 mm, I.D. 7.3 mm, W. 4.1 mm
Insulator

Replacing HITACHI

Rotors



132435

Replacing L235-21001, 23108-C8604
Servicing LR235-401, -402, LR240-401
 24 V. 40 Amp.
 L. 191 mm, O.D. 103 mm, Shaft 17 mm,
 16 splines
Shaft: Cargo 134438



135141

Replacing L150-31006, 23100-02N06
Servicing LR150-410C, -429F, -430C
 12 V. 50 Amp.
 L. 186 mm, O.D. 94.4 mm, Shaft 17 mm,
 16 splines
Shaft: Cargo 134074



135502

Replacing L170-91002, 23108-10G01
Servicing LR160-401, LR170-406B, -C,
 LR170-414B
 12 V. 70 Amp.
 L. 204 mm, O.D. 103 mm, Shaft 17 mm,
 8 splines

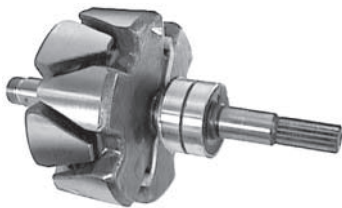

134968

Replacing L170-71001
Servicing LR170-411B, -C, -D, -415, -B,
 -419, -422B
 12 V. 70 Amp.
 L. 181 mm, O.D. 94.5 mm, Shaft 15 mm,
 16 splines

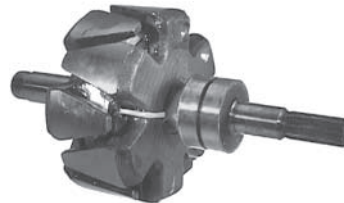

135142

Replacing L160-71006, -91002
Servicing LR160-401C
 12 V. 60 Amp.
 L. 189 mm, O.D. 94.4 mm, Shaft 17 mm,
 16 splines
Shaft: Cargo 135331

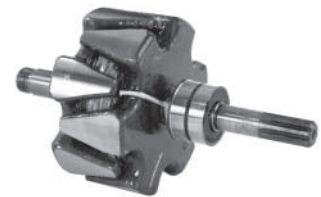

135503

Replacing L170-61002, -81002
Servicing LR170-402E, -417B
 12 V. 70 Amp.
 L. 191, O.D. 103 mm, Shaft 17 mm,
 8 splines
Shaft: Cargo 139291

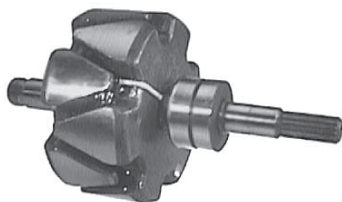

135139

Replacing L150-41009
Servicing LR150-431, -432,
 12 V. 50/70 Amp.
 L. 181 mm, O.D. 94.5 mm, Shaft 17 mm,
 16 splines
Shaft: Cargo 139290



135144

Replacing L225-9100, 23100-R8103
Servicing LR225-65P, -67P, -403
 24 V. 25 Amp.
 L. 186 mm, O.D. 94.5 mm, Shaft 17 mm,
 16 splines
Shaft: Cargo 134074



135504

Replacing L160-31007, 23100-V7200
Servicing LR170-402, -402B, -402C,
 -404, -404B, -404C, -421, -421B, -424
 12 V. 70 Amp.
 L. 191 mm, O.D. 103.3 mm, Shaft 17 mm,
 16 splines
Shaft: Cargo 134438

Replacing HITACHI



135505

Replacing L150A-4100, 23100-10G00
Servicing LR150-428T
 12 V. 50 Amp.
 L. 211 mm, O.D. 94.4 mm, Shaft 17 mm,
 16 splines
Shaft: Cargo 135332



135592

Replacing L170-71002
Servicing LR150-438B, -439B,
 LR155-418B, -419B, LR 170-411 E, -415C
 12 V. 50/70 Amp.
 L. 181 mm, O.D. 94.5 mm, Shaft 17 mm,
 8 splines
Shaft: Cargo 233320

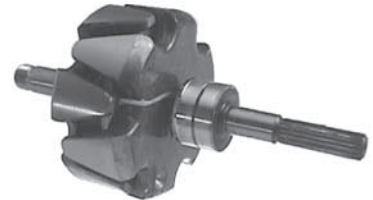

137065

Replacing L160-31009
Servicing LR160-426T, -437T, LR170-407T
 12 V. 70 Amp.
 L. 215.5 mm, O.D. 103.3 mm, Shaft 17 mm
 16 splines
Shaft: Cargo 230493



135506

Replacing L150-71001, 23708-AA000
Servicing LR150-200, LR155-20,
 LR160-137, -138, -139, -154
 12 V. 60 Amp.
 L. 145.5 mm, O.D. 94.4 mm, Shaft 17 mm



135826

Replacing L150-51002, -91004
Servicing LR150-98B, -E, -99B, -151,
 -151B, -165
 12 V. 50 Amp.
 L. 141.5 mm, O.D. 94.5 mm, Shaft 17 mm

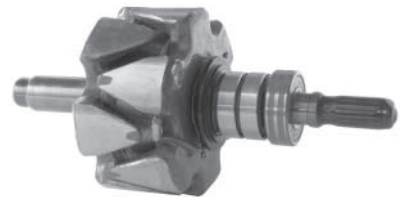

137186

Replacing L140M-11001, 23108-61503
Servicing LT140-106C
 12 V. 40 Amp.
 L. 194 mm, O.D. 91 mm, Shaft 17 mm,
 16 splines



135591

Replacing L160-81007, 23100-10G01
Servicing LR 160-422B, -426E,
 LR 170-406, -407E, -412, -414
 12 V. 70 Amp.
 L. 205 mm, O.D. 103.2 mm, Shaft 17 mm,
 16 splines
Shaft: Cargo 135330



136984

Replacing L140-11001
Servicing LR140-402, 408
 12 V. 40 Amp.
 L. 199 mm, O.D. 94.4 mm, Shaft 17 mm,
 16 splines
Shaft: Cargo 133665



137436

Replacing L140-81001
Servicing LR140-415B
 12 V. 40 Amp.
 L. 201 mm, O.D. 94.4 mm, Shaft 17 mm,
 16 splines
Shaft: Cargo 134831

Replacing HITACHI

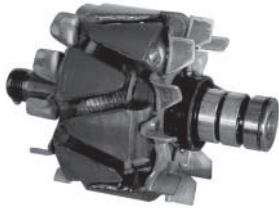

137456

Replacing L170-41002
Servicing LR170-734B, -739, -739B
 12 V. 70 Amp.
 L. 141 mm, O.D. 103 mm, Shaft 17 mm
Shaft: Cargo 137778

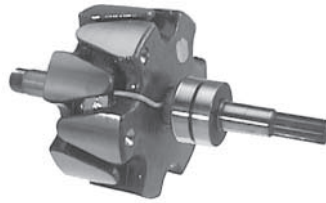

137749

Replacing L235-81001, 23108-10T07
Servicing LR235-404T, -405T,
 23100-10R07, -03T04
 24 V. 35 Amp.
 L. 201 mm, O.D. 103.3 mm, Shaft 17 mm,
 16 splines



138150

Replacing L160-41005, L170-7100
Servicing LR160-414, -417, -428, -432B
 12 V. 70 Amp.
 L. 191 mm, O.D. 103.3 mm, Shaft 17 mm,
 16 splines
Shaft: Cargo 134438



137460

Replacing L155-41001, -81001
Servicing LR155-16P, -408
 12 V. 55 Amp.
 L. 186 mm, O.D. 94.4 mm, Shaft 17 mm,
 16 splines
Shaft: Cargo 134074

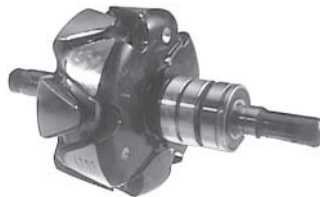

137823

Replacing L160-21009
Servicing LR160-108, -427T, -436T,
 LR170-407, -408T, -417, -428, -432B
 12 V. 70 Amp.
 L. 201 mm, O.D. 103.3 mm, Shaft 17 mm,
 16 splines
Shaft: Cargo 230492



138157

Replacing L160-51005
Servicing LR160-412B, -440, -441
 12 V. 60 Amp.
 L. 191 mm, O.D. 94.5 mm, Shaft 17 mm,
 16 splines
Shaft: Cargo 134438



137735

Replacing L235-91001
Servicing LR235-403T
 24 V. 35 Amp.
 L. 215.5 mm, O.D. 103.3 mm, Shaft 17 mm,
 16 splines

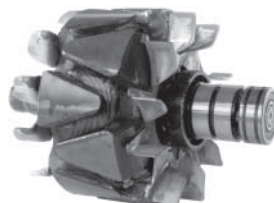

137966

Replacing L180-11001, L190-724
Servicing LR170-752, -752B,
 LR180-725E, -725C, -734B, -734C, -737B
 12 V. 90 Amp.
 L. 143 mm, O.D. 98 mm, Shaft 17 mm
Shaft: Cargo 137779



138158

Replacing L160G-51001
Servicing LR160-412F, -412G, -440F,
 -440G, -441F, -441G, -445B, -49, -450
 12 V. 60 Amp.
 L. 191 mm, O.D. 94.5 mm, Shaft 17 mm,
 8 splines

Replacing HITACHI



138341

Replacing L150-11005
Servicing LR150-135E, -147C, -162, -193
 12 V. 50 Amp.
 L. 183 mm, O.D. 94.3 mm, Shaft 17 mm,
 16 splines
Shaft: Cargo 134832



138693

Replacing L170-31002
Servicing LR170-732B, -C
 12 V. 70 Amp.
 L. 143 mm, O.D. 98 mm, Shaft 17 mm
Shaft: Cargo 137779



138737

Replacing L150A-3100
Servicing LR150-430T, -435T
 12 V. 50 Amp.
 L. 197 mm, O.D. 94.5 mm, Shaft 17 mm,
 16 splines



138690

Replacing L180-2100
Servicing LR170-713, -721, -721B,
 LR180-705, -705B, -710, -710B,
 LR190-704, -704B, -706, -707, -707B, -711
 12 V. 70/80/90 Amp.
 L. 140 mm, O.D. 103.5 mm, Shaft 17 mm



138715

Replacing L1110G-2100
Servicing LR1100-703B, -704B, -E, -705,
 -705B, -C, -E, -708, LR1110-705, -B,
 -706B, -C, -707C, -F, -G, -709B, -731
 12 V. 100/110 Amp.
 L. 143 mm, O.D. 107.5 mm, Shaft 17 mm
Shaft: Cargo 137779



138746

Replacing L170G-11001
Servicing LR170-501C, -502B, -C, -503,
 -504, -504B
 12 V. 70 Amp.
 L. 196 mm, O.D. 107.5 mm, Shaft 17 mm,
 8 splines

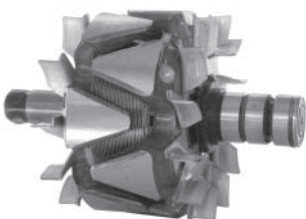

138692

Replacing L170-3100
Servicing LR170-701B, -E, -702B
 12 V. 70 Amp.
 L. 143 mm, O.D. 94.5 mm, Shaft 15 mm
Shaft: Cargo 137780

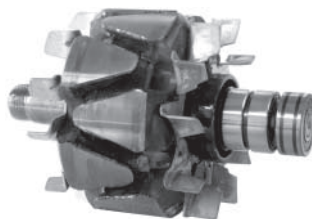

138725

Replacing L170G-71001
Servicing LR165-708E, -711, -711B,
 LR170-743, -746B, -C, -E, -F, -G, -J, -750C, -E
 12 V. 70 Amp.
 L. 143 mm, O.D. 92.5 mm, Shaft 17 mm
Shaft: Cargo 137779



138858

Replacing L140-51001
Servicing LR140-427
 12 V. 40 Amp.
 L. 187 mm, O.D. 95 mm, Shaft 17 mm,
 16 splines

Replacing HITACHI



139142

Replacing L150-71002
Servicing LR150-136E, -201, -201B, -205, -205B
 12 V. 50 Amp
 L. 189 mm, O.D. 95 mm, Shaft 17 mm
 16 splines
Shaft: Cargo 135331



139982

Replacing L170-41001
Servicing LR170-22, 23100-17C00
 12 V. 70 Amp.
 L. 141 mm, O.D. 103.3 mm, Shaft 20 mm



230127

Replacing L160-41002
Servicing LR160-96C, -108B, -131
 12 V. 60 Amp.
 L. 192 mm, O.D. 103.3 mm, Shaft 17 mm,
 16 splines



139789

Replacing L160-51006
Servicing LR160-144
 12 V. 60 Amp.
 L. 203 mm, O.D. 103.4 mm, Shaft 17 mm,
 16 splines



230055

Replacing L170G-41002
Servicing LR170-505, -505B, -506, -506B
 12 V. 70 Amp.
 L. 196 mm, O.D. 98 mm, Shaft 17 mm,
 6 splines



230128

Replacing L160-51001
Servicing LR160-67H, -92C, -107B, -164
 12 V. 60 Amp.
 L. 189 mm, O.D. 103.3 mm, Shaft 17 mm,
 16 splines



139790

Replacing L160G-21002
Servicing LR160-446, -446B, -446C, -446E
 12 V. 60 Amp.
 L. 205 mm, O.D. 94 mm, Shaft 17 mm,
 8 splines



230063

Replacing L135-61001, -71001
Servicing LR135-74, -74B, -86, -86F, -93, -95, -95B, -104, -105, -115, -121, -125, -126, -127, -128
 12 V. 35 Amp.
 L. 137 mm, O.D. 83 mm, Shaft 19 mm



230129

Replacing L160-31002, -41003
Servicing LR160-93, -104, -113, -125
 12 V. 60 Amp.
 L. 141 mm, O.D. 103 mm, Shaft 17 mm
Shaft: Cargo 137778

Replacing HITACHI

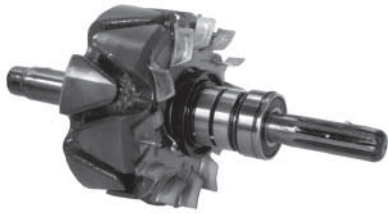

230468

Replacing L180G-5100
Servicing LR180-501B
 12 V. 80 Amp.
 L. 220.3 mm, O.D. 103.3 mm, Shaft 17 mm,
 8 splines



230888

Replacing L160G-41001
Servicing LR160-407S, -412S, -426S,
 -437S
 12 V. 70 Amp.
 L. 212.5 mm, O.D. 103.3 mm, Shaft 17 mm,
 8 splines

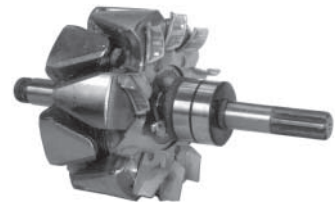

231986

Replacing L190G-2100
Servicing LR190-504C, -511, -511B,
 LR1100-501, -501B
 12 V. 100 Amp.
 L. 196 mm, O.D. 107.5 mm, Shaft 17 mm,
 8 splines

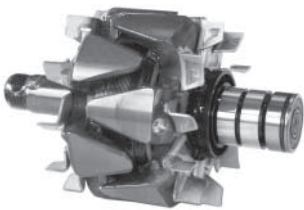

230869

Replacing L165-6100, -7100
Servicing LR165-707, -707B
 12 V. 65 Amp.
 L. 143 mm, O.D. 91 mm, Shaft 17 mm

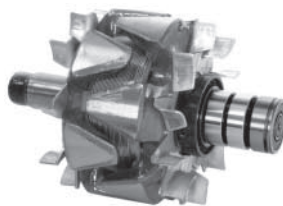

230892

Replacing L170-8100, -11001, -31001
Servicing LR170-714, -715, -715B, -716,
 -716B, -717, LR180-711B, -711E, -712,
 -712B, -714, -714B, -716, -718, -718B
 12 V. 70 Amp.
 L. 143.3 mm, O.D. 94.5 mm, Shaft 17 mm



232233

Replacing L150G-7100
Servicing LR150-428S, -443S
 12 V. 50 Amp.
 L. 211.5 mm, O.D. 94.5 mm, Shaft 17 mm,
 8 splines



230887

Replacing L160-21006, -81001
Servicing LR160-78B, -82, -82B
 12 V. 60 Amp.
 L. 141.5 mm, O.D. 103 mm, Shaft 17 mm



231615

Replacing L225-31002
Servicing LR225-84, -84T, -88
 24 V. 25 Amp.
 L. 140 mm, O.D. 95 mm, Shaft 17 mm



233250

Servicing LR170-418B, -418C
 12 V. 70 Amp.
 L. 218 mm, O.D. 103 mm, Shaft 17 mm,
 8 splines

Replacing HITACHI



233759

Replacing L150G-51001
Servicing LR150-444B, -448
 12 V. 50 Amp.
 L. 201.5 mm, O.D. 94.5 mm, Shaft 17 mm,
 8 splines

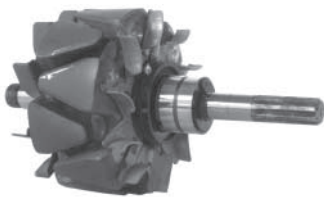

233768

Servicing LR1100-502E
 12 V. 100 Amp.
 L. 202 mm, O.D. 107.5 mm, Shaft 17 mm,
 8 splines

235368

Servicing LR180-762, -762B, 768
 12 V. 80 Amp.
 L. 143 mm, O.D. 98 mm, Shaft 17 mm
Bearing: Cargo 140235

Rotor Parts



191298 Std pkg 100 A

M14-1.5
 Rotor shaft nut



191299 Std pkg 100 A

Replacing L150-1810
Servicing LR125-40, LR140-130P,
 LR150-101, LR155-20, LR160-105
 M16-1.5 mm
 Rotor shaft nut



133665

Servicing L140-11001,
 L150-41008, -82002, Cargo 136984
 L. 199 mm, Shaft 17 mm, 16 Splines



133666

Servicing L140-31001, -61001
 L. 191 mm, Shaft 17 mm, 16 splines



134074

Servicing L140-31001, -61001, L150-
 61001, L225-9100,
 Cargo 135141, 135144, 137460
 L. 186 mm, Shaft 17 mm, 16 Splines



134438

Servicing L160G-51001, -31007
 Cargo 132435, 135504, 138150, 138157
 L. 191 mm, Shaft 17 mm, 16 Splines



134831

Servicing L140-81001,
 Cargo 137436
 L. 201 mm, Shaft 17 mm, 16 Splines



134832

Servicing L150-11005,
 Cargo 138341
 L. 183 mm, Shaft 17 mm, 16 Splines



135330

Servicing L160-81007,
 Cargo 135591
 L. 205 mm, Shaft 17 mm, 16 Splines



135331

Servicing L150-71002,
 L160-71006, Cargo 135142
 L. 189 mm, Shaft 17 mm, 16 Splines

Replacing HITACHI



135332

Servicing L150A-4100,
Cargo 135505
L. 211 mm, Shaft 17 mm, 16 Splines



137780

Servicing LR160-707, -708, -715,
Cargo 138692
L. 143 mm, Shaft 15 mm



233320

Servicing L170-71002,
Cargo 135592
L. 181 mm, Shaft 17 mm, 8 Splines



137770

Servicing L160-51001,
Cargo 230128
L. 189 mm, Shaft 17, 16 Splines



139290

Servicing L170-71001, Cargo 135139
L. 181 mm, Shaft 17 mm, 16 Splines



137777

Servicing LR150-31, -35, -36, -52, -53,
-58, LR160-42
L. 153.9 mm, Shaft 17 mm



139291

Servicing L170-61002, -81002,
Cargo 135503
L. 191 mm, Shaft 17 mm, 8 Splines



137778

Servicing LR170-41002, Cargo 137456,
230129
L. 141 mm, Shaft 17 mm



230492

Servicing L160-21009, Cargo 137823
L. 201 mm, Shaft 17 mm, 16 Splines



137779

Servicing LR165-707, LR170-732,
Cargo 137966, 138693, 138715, 138725
L. 143 mm, Shaft 17 mm



230493

Servicing L160-31009, Cargo 137065
L. 215.5 mm, Shaft 17 mm, 16 Splines

Replacing HITACHI

Stators



132436

Replacing L120-42001
Servicing LR120-23, LR135-74, -74,
 LR150-151B
 12 V. 20/50 Amp.
 O.D. 110 mm, I.D. 84 mm, W. 18.3 mm



132439

Replacing L150-62002, L155-32001
Servicing LR155-16P, -408
 12 V. 55 Amp.
 O.D. 124 mm, I.D. 95 mm, W. 18.2 mm



132442

Replacing L160-52002, 23102-29W00
Servicing LR160-401
 12 V. 60 Amp.
 O.D. 124 mm, I.D. 94.8 mm, W. 22 mm



132437

Replacing L140-22001, 5-81211-0410
Servicing LR135-107, -108, LT140-109B,
 -109C, -109D, -110C
 12 V. 40 Amp.
 O.D. 114 mm, I.D. 83.5 mm, W. 27 mm



132440

Replacing L155-4200
Servicing LT150-25, LT155-08
 12 V. 55 Amp.
 O.D. 127 mm, I.D. 92 mm, W. 25.2 mm



132443

Replacing L225-82001
Servicing LR225-67P, -408E, -409B,
 -412T, -413, -414T, -415B, -418B
 24 V. 25 Amp.
 O.D. 124 mm, I.D. 95 mm, W. 18 mm



132438

Replacing L150-22004, L160-52004
Servicing LR140-130P, -419T, -421T,
 -422T, LR150-98E, -99B, -218, -401C,
 -419B, 423B, -428
 12 V. 50 Amp.
 O.D. 124 mm, I.D. 95 mm, W. 18.1 mm



132441

Replacing L160-32001, -52001, -72003
Servicing LR160-92C, -96C, -107B,
 -108B, -131, -144, -164, -414, -417, -421C,
 -426T, -427T, -428, -436T
 12 V. 60 Amp.
 O.D. 135 mm, I.D. 104 mm, W. 22.2 mm



132444

Replacing L235-22001
Servicing LR235-70B, -75C, -78B, -402,
 -403T, -404T, -405T
 24 V. 35 Amp.
 O.D. 135 mm, I.D. 104 mm, W. 22.2 mm

Replacing HITACHI



133186

Replacing L160-32003, 23102-S0405
Servicing LR160-702B, -707, -708C
 12 V. 60 Amp.
 O.D. 117 mm, I.D. 91.3 mm, W. 22 mm



134515

Replacing L170-12001, 23102-07201
Servicing LR170-402E, -404B, -406C, -407T, -406B, -408T, -412T, -413, -414B, -417B, -412, LR180-01B
 12 V. 70 Amp.
 O.D. 135 mm, I.D. 104 mm, W. 22.3 mm



135019

Replacing L225-22001
Servicing LR225-65C, -65E, -68B, -80B
 24 V. 25 Amp.
 O.D. 124 mm, I.D. 95 mm, W. 22 mm



133761

Replacing L160-4200L, 23102-V0101
Servicing LR160-82B
 12 V. 60 Amp.
 O.D. 135 mm, I.D. 104 mm, W. 18 mm



134817

Replacing L170-22001, 23102-58500
Servicing LR170-714, -715B, -716B, -717, -719B
 12 V. 70 Amp.
 O.D. 124 mm, I.D. 95 mm, W. 22 mm



135269

Replacing L170-82001, 23102-0P00
Servicing LR170-732C, LR190-715, -716, -717, -718, -719, -720
 12 V. 70/90 Amp.
 O.D. 129 mm, I.D. 98,5 mm, W. 22 mm



133917

Replacing L165-2200, 23102-77A00
Servicing LR165-707B
 12 V. 65 Amp.
 O.D. 117 mm, I.D. 91.5 mm, W. 22 mm



134969

Replacing L170-72001
Servicing LR170-411A
 Opel Corsa Diesel
 12 V. 70 Amp.
 O.D. 124 mm, I.D. 95 mm, W. 18 mm



135333

Servicing LR170-419, -422B
 Opel Corsa Diesel
 12 V. 70 Amp.
 O.D. 124 mm, I.D. 95 mm, W. 18 mm

Replacing HITACHI



136185

Replacing L155-42001
Servicing LR155-20
 Yanmar
 12 V. 55 Amp.
 O.D. 124 mm, I.D. 94.8 mm, W. 18.3 mm



137421

Replacing L180-9200
Servicing LR180-725, -725C, -730, -731B, -731C, -733, -735, -738
 12 V. 80 Amp.
 O.D. 126 mm, I.D. 98.5 mm, W. 22 mm



138186

Replacing L140M-12001
Servicing LT140-57, -106C
 12 V. 40 Amp.
 O.D. 121 mm, I.D. 92 mm, W. 23 mm



136262

Replacing L170-22002
Servicing LR170-420
 Opel
 12 V. 70 Amp.
 O.D. 135 mm, I.D. 104 mm, W. 22 mm



138147

Replacing L190-2200
Servicing LR190-704, -704B, -706, -707, -707B, -709, -711
 12 V. 90 Amp.
 O.D. 135 mm, I.D. 104 mm, W. 22 mm



138188

Replacing L170G-6200, -9200
Servicing LR170-505, -506, -740B, -745, -745B, -752, -752B
 12 V. 70 Amp.
 O.D. 125.7 mm, I.D. 98.5 mm, W. 22 mm



136683

Replacing L170-42002, 23102-50Y06
Servicing LR170-738,B,C
 12 V. 70 Amp.
 O.D. 117.5 mm, I.D. 93 mm, W. 22 mm



138153

Replacing L135N-2200
Servicing LT115-52, LT120-05, -21, LT125-06, LT130-72, LT135-13, -20, -24B, -30C, -35, -35C, -38C, -54, -68, -73B
 12 V. 35 Amp.
 O.D. 110 mm, I.D. 84 mm, W. 19.3 mm



138481

Replacing L160G-1200, L165-8200
Servicing LR160-724, LR165-708, -708B, -708C
 12 V. 65 Amp.
 O.D. 117.5 mm, I.D. 93 mm, W. 22 mm

Replacing HITACHI



138716

Replacing L1110G-2200
Servicing LR1110-705, -B, -706B, -C, -707C, -F, -G, -709B
 12 V. 110 Amp.
 O.D. 136 mm, I.D. 108 mm, W. 22 mm



138861

Replacing L180-2200
Servicing LR180-710B
 12 V. 80 Amp.
 O.D. 135 mm, I.D. 104 mm, W. 22 mm

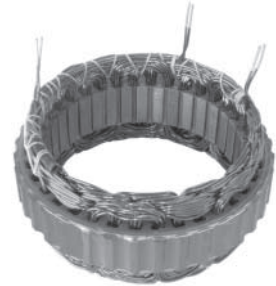

230467

Replacing L180G-1200
Servicing LR180-501B
 12 V. 80 Amp.
 O.D. 135 mm, I.D. 104 mm, W. 22.2 mm



138726

Replacing L170G-12001
Servicing LR170-746E, -F, -G, -J, -750C, -E
 12 V. 70 Amp.
 O.D. 117.5 mm, I.D. 93 mm, W. 22 mm



139978

Replacing L170-92001
Servicing LR170-734B, -739, -739B, -740
 12 V. 70 Amp.
 O.D. 126 mm, I.D. 98.5 mm, W. 22 mm

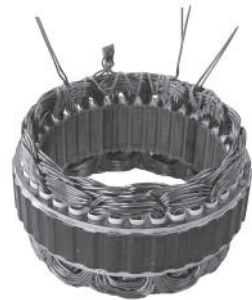

230481

Replacing L165G-2200
Servicing LR165-708E, -711, -711B
 12 V. 65 Amp.
 O.D. 117.5 mm, I.D. 93 mm, W. 22.1 mm



138738

Replacing L170G-1200, L190G-3200
Servicing LR170-502B, -C, -503, -504, -504B
 12 V. 70/90 Amp.
 O.D. 136.5 mm, I.D. 108.5 mm, W. 22 mm



230130

Replacing L1100G-1200
Servicing LR195-701, LR1100-501, -501B
 12 V. 100 Amp.
 O.D. 136.5 mm, I.D. 108.5 mm, W. 22 mm



230864

Replacing L190G-5200
Servicing LR185-701, -701B, -701C, -701E, -702, LR190-715E, -716B, -717C, -718B, -719B, -720B, -721, -722B, -724
 12 V. 90 Amp.
 O.D. 126 mm, I.D. 98 mm, W. 23 mm

Replacing HITACHI



231356

Replacing L180-7200
Servicing LR180-711B, -711E, -712, -712B, -714, -714B, -716, -718B
 12 V. 80 Amp.
 O.D. 124 mm, I.D. 95 mm, W. 22 mm



231618

Replacing L180G-3200
Servicing LR180-725E, -733B, -734C, -737C, -738B, -741, -741B, -741C, -743, -743B, -745, -745B, -745C, -746, -746B
 12 V. 80 Amp.
 O.D. 126 mm, I.D. 88.5 mm, W. 22 mm



234694

Replacing L1110-1200
Servicing LR1110-701, -701B, -703B, -704
 12 V. 110 Amp.
 O.D. 137 mm, I.D. 108 mm, W. 29 mm



231616

Replacing L225G-1200
Servicing LR225-88
 12 V. 25 Amp.
 O.D. 124 mm, I.D. 86 mm, W. 18 mm



233607

Replacing L1100G-3200
Servicing LR190-734, -734B, -734C, -734E, -734G
 12 V. 90 Amp.
 O.D. 135.5 mm, I.D. 108 mm, W. 22.1 mm



234729

Servicing LR1100-502E, -502F, -502G, -502H, -502J
 12 V. 100 Amp.
 O.D. 136 mm, I.D. 108 mm, W. 22 mm



231617

Replacing L145-42001
Servicing LR145-701GA, -702, -702B, -703, -704, -707
 12 V. 45 Amp.
 O.D. 104 mm, I.D. 81 mm, W. 22 mm



234693

Servicing LR180-744
 12 V. 80 Amp.
 O.D. 126 mm, I.D. 98 mm, W. 28 mm

Replacing HITACHI

Brackets D.E.



134713

Replacing L145-3400
Servicing LR145-701E
 W/ bearing



136451

Replacing L160-24001, 23118-V0101
Servicing LR160-82B, -84B, LR170-02B
 W/ bearing



137126

Replacing L150-64004
Servicing LR150-431, -432, -438B, -439B, LR155-415, -416, -418B, -419B
 W/ bearing



136138

Replacing L150-34001, 23118-W1700
Servicing LR140-402, -408, -410F, -411F, -415B, -419T, -421T, -422T, -423F, LR150-79H, -133E, -139P, -148C, -157B,
 W/ bearing



136578

Replacing L160-34001
Servicing LR160-93, -104, -113
 Bearing: Cargo 140093



137298

Replacing L190-3400
Servicing LR170-721B, LR190-704B, -709B, -711
 Bearing: Cargo 140093



136450

Replacing L150-64001, 23118-21G00
Servicing LR150-98E, -99B, -101B, -125B
 W/ bearing



137122

Replacing L160-14009, -44003
Servicing LR160-67H, -78C, -85B, -92C, -96C, -105, -107B, -108B, -109C, -116, -130, -131, -133, -144, -164, -167, -414



137428

Replacing L150-44001, -64002
Servicing LR150-135E, -136E, -147C, -162, -192, -193, -201B, -202, -203, -205B, -206, -211B, -212B
 W/ bearing

Replacing HITACHI



137781

Replacing L170G-1400
Servicing LR170-404, -404B, -404C, -421, -421B
 W/ bearing



137965

Replacing L180-44001
Servicing LR180-725, -725C, -725E, -737B, -737C
 W/ bearing



138734

Replacing L170G-14001
Servicing LR165-711, -711B, LR170-743, -746B, -746C, -746E, -746F, -746G, -746J, -750C, -750E
 W/ bearing



137782

Replacing L165-5400
Servicing LR165-708, -B, -C, -E, LR170-738, -B, -C, -E
 W/ bearing



138479

Replacing L170-64001
Servicing LR170-732, -732C
 W/ bearing



138764

Replacing L180G-4400
Servicing LR190-719
 W/ bearing



137943

Replacing L170G-3400
Servicing LR170-739, -739B
 W/ bearing



138721

Replacing L1125G-2400
Servicing LR1100-703, -703b, LR1110-705, -705B, -706B, -706C, -709B, LR1125-702, -702B, -702C, -702F
 W/ bearing



139578

Replacing L165G-2400
Servicing LR165-709, -709B, -712
 W/ bearing

Replacing HITACHI



139791

Replacing L150-84003, L150G-3400
Servicing LR140-427, -433, -B, LR150-421C, -434B, -441C, -442, -444B, -446, -448, -449, -449B, -449C, LR160-419, -444, -B, -446, -446B, -446C
 W/ bearing



230482

Replacing L160-44002, L170G-2400
Servicing LR170-402B, -C, -E, -F, -424, -B
 Bearing: Cargo 140093



231440

Replacing L160G-14001
Servicing LR160-728, -728B, -728C, -728E, -732, -732B, LR225-702, LR235-705
 W/ bearing



139794

Replacing L170G-74001
Servicing LR170-505, -505B, -506
 W/ bearing



230663

Replacing L150-74003, L225-6400
Servicing LR225-408B, -C, -E, -409B, -415B, -418C
 W/ bearing



231443

Replacing L170G-4400
Servicing LR170-417B, -417C, -417E, -417F, -502P, -502Q
 W/ bearing



139795

Replacing L120-2401
Servicing LR120-15C, LR125-34, LR135-61B, -91
 Bearing: Cargo 140084



230664

Replacing L170-5400
Servicing LR170-715, -715B, -716, -716B
 W/ bearing



231521

Replacing L165-4400
Servicing LR165-707, -707B
 Bearing: Cargo 140093

Replacing HITACHI



231612

Replacing L170G-7400
Servicing LR170-740, -740B, -752, -752B, LR190-720, -720B, -733, -733B
 W/ bearing



232423

Servicing LR170-411, -411B, -411C, -411D
 Bearing: Cargo 140093



234436

Replacing L180G-8400
Servicing LR180-735, -735B
 Bearing: Cargo 140093



231620

Replacing L140-24002
Servicing LR140-703, -704, -705, LR145-701GA, -703, -705
 W/ bearing



233323

Servicing LR170-509C, -509E, -509F, LR1100-502E, -502F, -502G, -502J
 Bearing: Cargo 140093

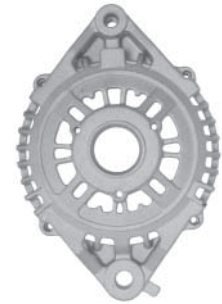

234747

Servicing LR180-762, -768, LR190-752
 Bearing: Cargo 140093



231854

Servicing LR180-736
 Bearing: Cargo 140093



233605

Replacing L190G-44001
Servicing L190-734, -734B, -734C, -734E, -734G
 W/ bearing

Replacing HITACHI

Brackets S.R.E.



137124

Replacing L150-63016, -93019
Servicing LR140-402, -408, LR150-139P, -423B, LR155-16P, -408

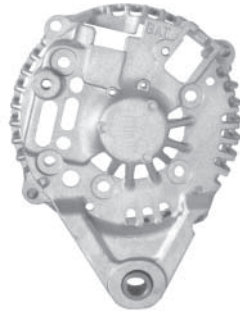

137420

Replacing L180G-8301
Servicing LR180-725, -725C
Bearing: Cargo 140235



137520

Replacing L165-6301
Servicing LR165-707, -707B

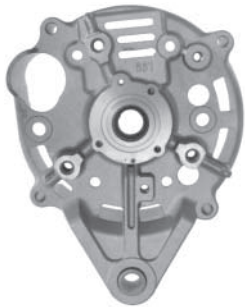

137125

Replacing L150-33018
Servicing LR150-421C, -431, -432, -434B, LR155-415, -416
W/ oil seal



137426

Replacing L155-8301
Servicing LR150-200, LR155-23, LR160-137, -138, -139,
Bearing: Cargo 140081



137586

Replacing L150-13014
Servicing LR155-15



137297

Replacing L180-4301, L190-4301
Servicing LR170-721B, LR190-704B, -709B, -711

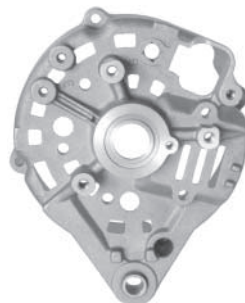

137429

Replacing L170-13011, L170G-1301
Servicing LR170-402, -402B, -402C, -402E, -402F, -404, -404B, -404C, -424, -424B
W/ oil seal
Bearing: Cargo 140434



137708

Replacing L160A-3301
Servicing LR160-422, LR235-402

Replacing HITACHI



137709

Replacing L150-53015
Servicing LR150-136E, -201, -201B, -205B, LT150-115C, -154, -196, LT225-75, -76B



138691

Replacing L165-8301, L165G-3301
Servicing LR165-708, -708B, -708C, -708E, -738, -738C, -738E



139793

Replacing L160G-3301
Servicing LR160-426S, -427S, -436S, -437S, LR170-407S, -408S, -412S
 W/ oil seal

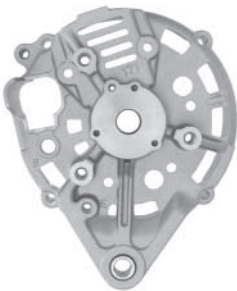

137840

Replacing L160A-23012
Servicing LR160-426T, -427T, -436T, LR170-407, -407T, -408T, -412T, LR235-403T, -404T, -405T

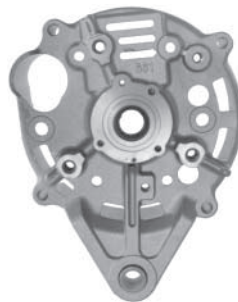

139275

Replacing L150-73005A
Servicing LR150-446, -446B, -46C, LR160-418B, -419, -443, -444, -446, -446B, -446C

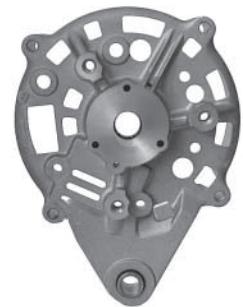

139796

Replacing L160-73018
Servicing LR140-410BA, -411BA, -423, LR150-410CA, LR155-407CA, -410A, -410BA, -414
 W/ oil seal



137942

Replacing L170G-2301
Servicing LR170-739, -739B

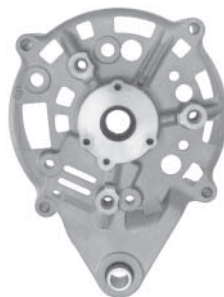

139577

Replacing L150G-2301, -33011
Servicing LR140-410F, -410G, -411B, -411F, -411G, -423F, -429B, -430, LR150-410F, -G, -419B, -419F, -419G, -450B, -451, LR155-407B, -407F, -407G
 W/ oil seal



139804

Replacing L120-33011
Servicing LR120-15C, -16B, -23, LR125-34, LR135-91, -95, -121, -127, -128

Replacing HITACHI

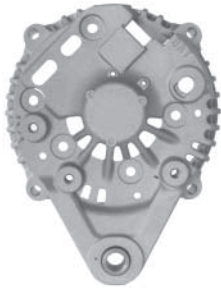

139892

Replacing L180G-1301
Servicing LR170-740, -740B,
 LR190-719, -719B, -720, -720B
 W/ bearing



230131

Replacing L170-23015
Servicing LR170-732, -732C



230466

Replacing L160A-63011
Servicing LR160-109C, -167
 Bearing: Cargo 140081



230056

Replacing L170-93011
Servicing LR170-715B, -716B,
 LR180-716
 Bearing: Cargo 140235



230133

Replacing L150G-1301
Servicing LR150-428S, -430S, -435S,
 -443S
 W/ oil seal



230483

Replacing L160A-93017
Servicing LR160-121, -124, LR225-85

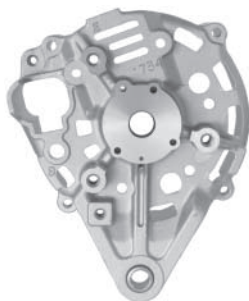

230064

Replacing L150A-23011
Servicing LR140-419T, -421T, -422T,
 LR150-428T, -430T, -435T, -443T,
 LR225-412T, -413T, -414T
 W/ oil seal
 Bearing: Cargo 140434



230211

Replacing L170G-33005
Servicing LR170-505, -505B



230484

Replacing L160G-4301
Servicing LR160-412B, -F, -G, -440F, -G,
 -441F, -G, -449, -450
 W/ oil seal

Replacing HITACHI

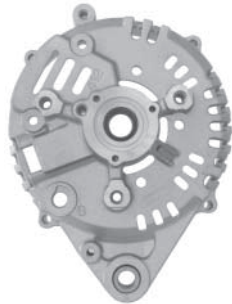

230690

Replacing L190G-6301
Servicing LR170-502B, -C, LR190-511, -B
 W/ oil seal
 Bearing: Cargo 140434



231445

Replacing L160A-83012, L170G-13011
Servicing LR160-421C, -421E, -421F, LR170-406B, -406C, -406E, -406F
 W/ oil seal
 Bearing: Cargo 140434



234749

Replacing L180G-2301
Servicing LR180-735, -735B
 Bearing: Cargo 140235



230876

Replacing L180-53011
Servicing LR170-420
 Bearing: Cargo 140434



231855

Servicing LR180-736
 Bearing: Cargo 140235



230889

Replacing L190G-3301
Servicing LR180-504, -506B
 W/ oil seal
 Bearing: Cargo 140434

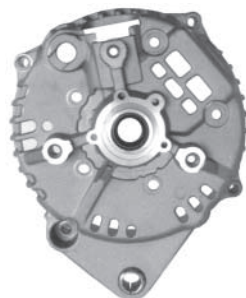

233129

Servicing LR1100-502E, -502F, -502G, -502J
 W/ oil seal

Replacing HITACHI

Bracket Parts



134276 Std pkg 10 **A**
10.5 x 17/22 x 15 mm
Mounting bushing, S.R.E.



134277 Std pkg 10 **A**
10 x 16.5 x 15.3 mm
Mounting bushing, S.R.E.



134278 Std pkg 10 **A**
8.5 x 15.3 x 15.3 mm
Mounting bushing, S.R.E.



135281 Std pkg 10
8.3 x 15/22 x 16 mm
Mounting bushing, S.R.E.



232669 Std pkg 5
10 x 15/24 x 20 mm
Mounting bushing, S.R.E.



234825 **N**
Servicing LR160-728B, -728C, -728E,
-728F, LR170-509E, LR1100-502E, -502F,
-502G, -502H, -502J
10.5 x 15.5/22.4 x 18.1 mm
Mounting bushing, S.R.E.



234836 **N**
Servicing LR160-727, -728B, -728C,
-728E, -728F, LR165-711B, -714,
LR170-505B, -509C, -509E, -509F, -509G,
-509H, -511, -740, -740B, -758, -764,
LR180-725E, -736B, -749, -749B, -749C
Bearing retainer

Covers



135124

Replacing L125-6338, 5 81218 0100
Servicing LT130-81, -89, LT135-24B,
-30, -35C, -38C, -54, -68, -73B, LT160-32
For rectifier

Replacing HITACHI

Regulators



130620

Replacing TL1Z-61, 23500-29901
Servicing Nissan
 12 V.
 Electronic
In mechanic: Cargo 133387

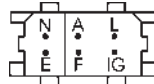

130630

Replacing TL1Z-82, -82B, 23500-N6000
Servicing Nissan
 12 V.
 Electronic



130832

Replacing L150-43151, 23133-Q4601
Servicing LR150-100, LR160-77, -79,
 12 V.
Repair circuit: Cargo 130834
Brush box: Cargo 132096



130621

Replacing TL1Z-53, -60, 23500-M0110
Servicing Nissan
 12 V.
 Electronic



130631

Replacing TL1Z-85B, -85D, 23500-B8000
Servicing Nissan
 12 V.
 Electronic

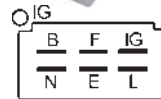

131025

Replacing TL1Z-27, -54, -65, -74
Servicing Nissan, Subaru
 12 V.

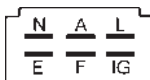

130622

Replacing TL1Z-58, 23500-21600
Servicing Nissan
 12 V.
 Electronic
 Mounting holes threaded



130831

Replacing L150-13152, 23133-P2500
Servicing LR150-30B, -31B, -36, -50,
 -51, -52, -53, -58, -66, -67
 12 V.
Repair circuit: Cargo 130834
Brush box: Cargo 132089

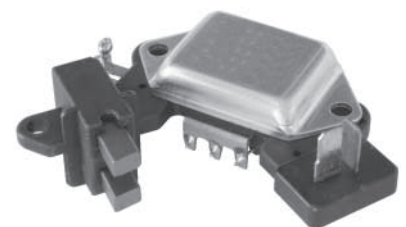

131529

Replacing L160-13151, 23133-P3005
Servicing LR160-42B, -43B, -51, -55,
 -57, -59, -62
 12 V.
 W/ diode trio
Repair circuit: Cargo 130834

Replacing HITACHI



131533

Replacing TL2Z-14, -17, 23500-90114
Servicing Nissan
 24 V.
 Mechanic



131537

Replacing TL2Z-15, -22
Servicing Isuzu
 24 V.
 Mechanic

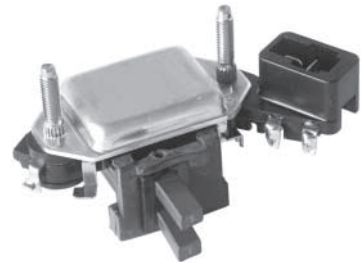

132432

Replacing L150-73154
Servicing LR140-406, -410F, -423F, LR150-410F
 12 V.
Repair circuit: Cargo 131287
Brush box: Cargo 132426

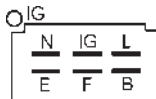

131535

Replacing TL1Z-87
Servicing Isuzu
 12 V.
 Mechanic

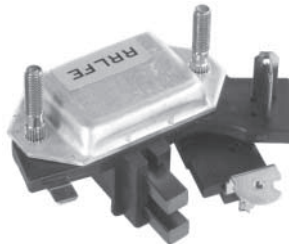

132429

Replacing L135-13152, -43153
Servicing LR120-23, LR135-91, -86F, -95, -104, -105, -106, -125, -126, -127, -128, Yanmar
 12 V. w/ capacitor
Repair circuit: Cargo 132434

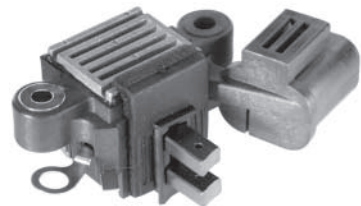

132991

Replacing L160-43154, L170-13151
Servicing LR160-715, LR170-714, 715B, -716B, -717, -719, LR180-711B
 12 V.
Repair circuit: Cargo 133250, only for O.E Style

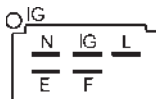

131536

Replacing TL1Z-08, -46, -48, -66
Servicing Isuzu
 12 V.
 Electronic
In mechanic: Cargo 133455



132431

Replacing L150-23155, 23528-29W00
Servicing LR155-16P, -408
 12 V.
Repair circuit: Cargo 131287
Brush box: Cargo 132426
Terminal block: Cargo 133727

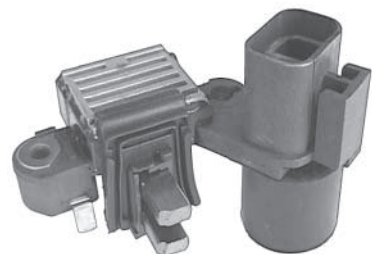

132992

Replacing L170-1315, 23133-04P01
Servicing LR170-701B, -702B, LR160-702B, 703B, 709
 12 V.
Repair circuit: Cargo 133247

Replacing HITACHI



132993

Replacing L180-7315, 23133-F6100
Servicing LR170-713, -721, LR180-704, LR190-704B, -711
 12 V.
Repair circuit: Cargo 133248, only for O.E Style



133455

Replacing TL1Z-66, Isuzu
 12 V.
Same as Cargo 131536 but mechanic

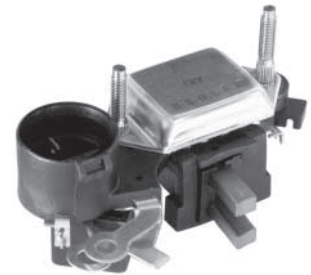

133544

Replacing L150-33155, 8 94167 4100
Servicing LR150-421, -431, -432, Isuzu
 12 V.
Repair circuit: Cargo 131287
Brush box: Cargo 132426
Terminal block: Cargo 134834



133185

Replacing L170-3315
Servicing LR160-707, -708, -710
 12 V.
Repair circuit: Cargo 133248

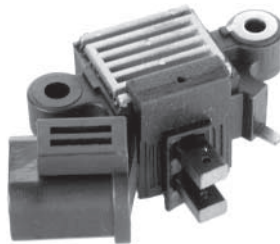

133529

Replacing L170-43151, 23133-77A00
Servicing LR165-707B
 12 V.
Repair circuit: Cargo 133248, only for O.E Style

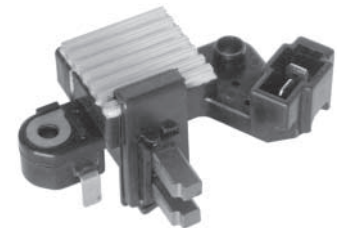

133763

Replacing L135-63153, 23733-KA010
Servicing LR145-701E
 12 V.

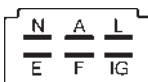

133387

Replacing TL1Z-61, 23500-29901
Servicing Nissan
 12 V.
Same as Cargo 130620 but mechanic

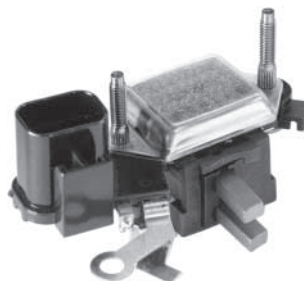

133543

Replacing L160-23153, 23528-05E06
Servicing LR160-421E, -421F, Nissan
 12 V.
Repair circuit: Cargo 131287
Brush box: Cargo 132426
Terminal block: Cargo 133499

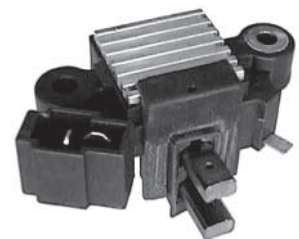

135020

Replacing L165-5315, 23733-A0010
Servicing LR165-704B, -705
 12 V.
Repair circuit: Cargo 133249

Replacing HITACHI

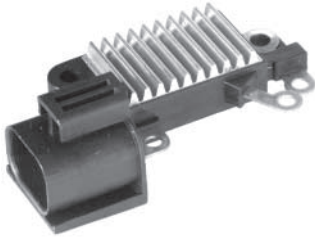

135021

Replacing L180G-2340, 23215-85L00
Servicing LR165-708C, LR170-738C, LR180-731B, LR190-715B
 12 V.



135027

Replacing L170-33152, 23215-50Y05
Servicing LR165-708B, LR170-738B, LR180-730
 12 V.

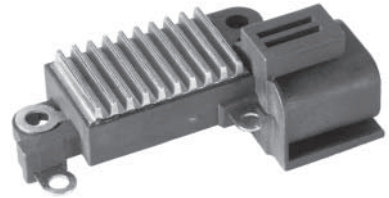

135158

Replacing L180-8315, 23215-64J00
Servicing LR170-734B, -739, LR180-725
 5 terminals
 12 V.
 Terminal L-S



135022

Replacing L180G-5340, 23215-64J02
Servicing LR160-724, LR170-739B, -740, -B, -741, LR180-725C, -E, -733B, -734B, -C, -736B, -737B, -C, LR190-716B
 12 V.
 Same as Cargo 135158 but 6 terminals

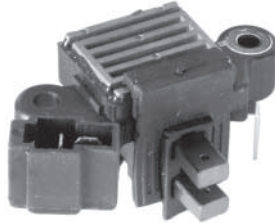

135028

Replacing L165-2315, 23733-AA000
Servicing LR165-704
 12 V.
 Repair circuit: Cargo 133248



137014

Replacing TR1Z-210A,B
Servicing LR155-502B, -502C, -502E, -503E, -504
 12 V.
 Terminal L-S

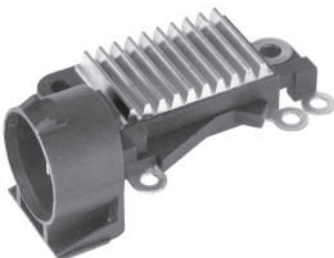

135024

Replacing L170-23152
Servicing LR170-732B, C, 23700-AA090
 Subaru
 12 V.
 Repair circuit: Cargo 135025



135029

Replacing L170-6315
Servicing LR160-706, LR170-703
 12 V.
 Repair circuit: Cargo 133247

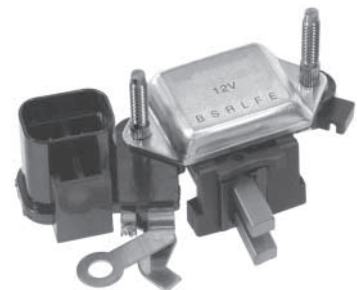

137189

Replacing L150-93155, L160-63153
Servicing LR150-428S, -428T, -430S, -430T, -435S, -435T, -443S, -443T, LR170-402E, -402F, -404B, -404C, -421
 12 V.
 Terminals L-S

Replacing HITACHI

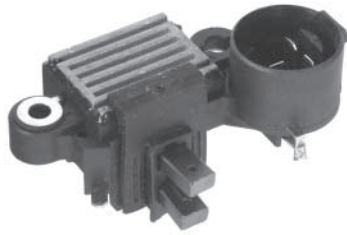

137364

Replacing L150-43156, 8-94462849-0
Servicing LR150-704, LR160-718H
 12 V.
 Terminals S-L-IG



137841

Replacing L170G-1315
Servicing LR170-420
 12 V.



138717

Replacing L1110G-9340
Servicing LR1100-703, -705, -707G,
 LR1125-702B
 12 V.
 Terminal L-S



137441

Replacing L155-6315
Servicing LR155-20,
 Yanmar
 12 V.
 Terminal R-L

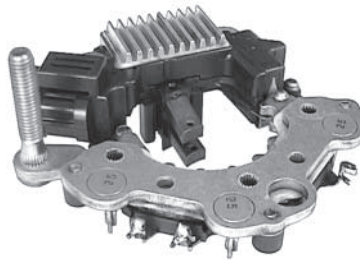

138190

Replacing L170G-6308
Servicing LR170-505
 12 V.
 w/ Rectifier, B+ terminal M8 x 38 mm
Rectifier only: Cargo 230094
Regulator only: Cargo 139980



138727

Replacing L170G-6315, L180G-23401
Servicing LR165-711, -711B, LR170-743,
 -745, -B, -746E, -F, -750C, -E, -752, -B,
 LR180-741B, LR190-725B, -E, -732
 12 V.
 Terminal L-S

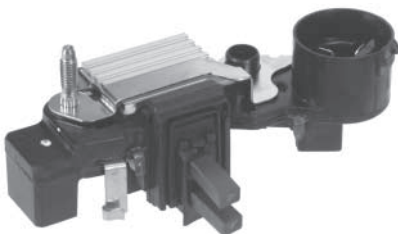

137584

Replacing L180G-2315
Servicing LR180-501B
 12 V.
 Terminals IG-L-S

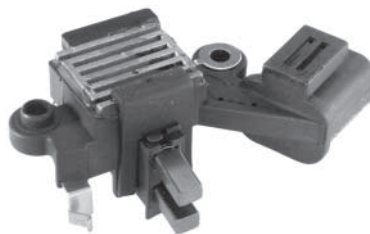

138671

Replacing L190-4315
Servicing LR180-705, -705B, -708, -710,
 -710B, -724, LR190-706, -707, -707B
 12 V.
 Terminal L-S



138740

Replacing TR1Z-108, -108B
Servicing LR170-501C, -502B, -C, -503,
 -504, -B, LR190-504C, -505C, -E, -511, -B,
 -512, -B, -C, -515, -B
 12 V.
 Terminal L-S

Replacing HITACHI



138986

Replacing L150-23156
Servicing LR160-140B, -154
 12 V.
 Terminal L-S



231292

Replacing L225-53151
Servicing LR260-18F, -20B, LR270-02F,
 -03B, -03C, -03E, -05, -06B, -06C, -07
 24 V.
 Terminal IG-L-S



231613

Replacing L225-43151
Servicing LR225-84, -84T, -88
 24 V.



139980

Replacing L170G-7315
Servicing LR170-505, -505B,
 Opel Corsa, Vectra
 12 V.
 Terminal L-W
Regulator/Rectifier: Cargo 138190

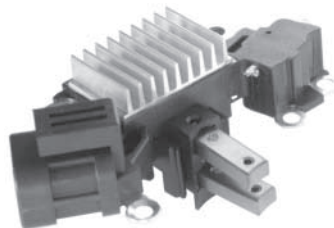

231533

Replacing L180G-63401, L190G-8340
Servicing LR160-728E, LR170-749F,
 LR180-749E, -749C, LR190-730C, -734C,
 -734E, LR1100-705E, -710, -710B
 12 V.
 Terminal L-S

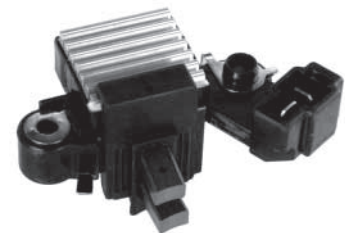

231622

Replacing L135-95153
Servicing LR140-703, -704, -705, -713,
 LR145-701GA, -702, -702B, -703, -705,
 -706, -707, -708, -708B, -709, -709B
 12 V.



230433

Replacing TR1Z-123
Servicing LR1100-501, -501B
 12 V.
 Terminal L-W



231534

Replacing L1100G-8340, -53402
Servicing LR1100-711B, LR1110-709B
 12 V.



231853

Replacing L170-73151
Servicing LR170-22, LR180-02
 12 V.

Replacing HITACHI

Volt setting 14.8 V



232074

Replacing TR1Z-125
Servicing Honda
 12 V.
 I.C. regulator

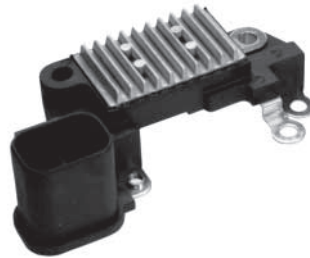

232441

Replacing L195G-1315, -2340
Servicing LR195-701
 12 V.
 Terminal L-S



233625

Servicing Golf carts
 12 V.
 Terminals: D+, DF, D-

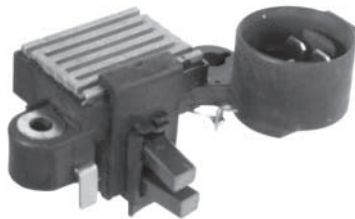

232439

Replacing L150-73155
Servicing LR150-703
 12 V.
 Terminal S-IG-L



232442

Servicing LR150-711, LR160-725, -726
 12 V.
 Terminal S-IG-L



233893

Replacing L225-8315
Servicing LR225-408B, -408C, -408E, -418B, -418C, LR235-401, -406, LR240-401, -402, -403B, -403C, -404B
 24 V.
 Terminals: B, S, R, L, F, E

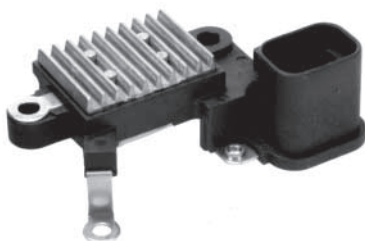

232440

Replacing L1110-1315, -2315
Servicing LR1100-702, LR1110-701, -702
 12 V.
 Terminal L-S

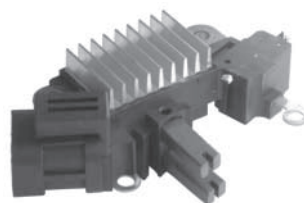

232443

Servicing LR170-509E, LR1100-502E
 12 V.
 Terminal L-W

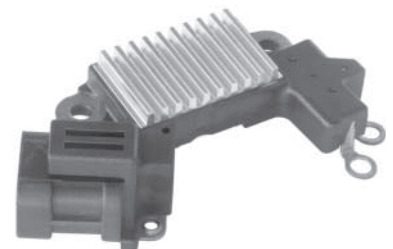

234273

Replacing L180G-2341, -3340, -33401
Servicing LR160-728B, -728C -732B, -732C, LR170-749C, -749E, LR180-743B, -746, -746B, -748B, LR190-728, -728B
 12 V.
 Terminals: L-S

Replacing HITACHI

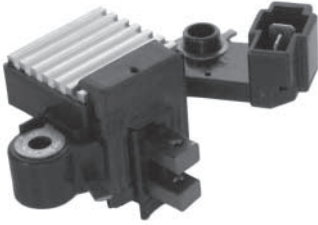

234276

Servicing LR140-708, -708C
Honda Gold Wing
12 V.
Terminals: IG, L

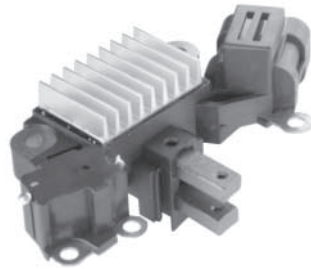

234314

Replacing L190G-33401, L1100G-7340
Servicing LR180-757, LR190-737, -753, -754, LR1100-716C, -716E, LR1125-706B
12 V.



234701

Replacing L225-9315
Servicing LR235-402, -403E, -403S, -403T, -404C, -405, -405S, -405T
24 V.
Terminals: L-S

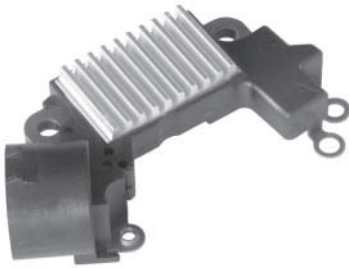

234289

Servicing LR160-729C, -730C, -731, LR170-755
12 V.
Terminals: S, L, C, IG

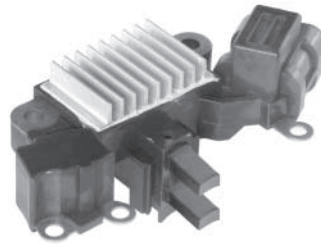

234612

Replacing L190G-7340
Servicing LR160-733, LR170-746G, -746K, -746M, -752C, -761B, -768, LR180-741C, -745C, LR190-725F, -732C
12 V.
Terminals: L-S



235000

Replacing L190G-2315 
Servicing LR170-501C, -502B, -502C, -503, -504, -504B, LR190-504C, -505E, -505F, -511B, -512B, -512C, -515B
12 V.
Terminals: L-S
I.C. regulator Cargo 138740



234311

Replacing L185G-2340
Servicing LR185-701, -702
12 V.
Used w/ brush box: Cargo 138719

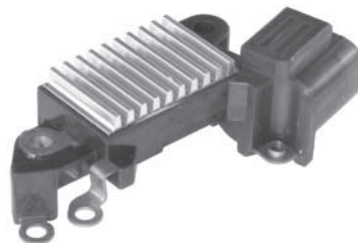

234613

Replacing L1110G-4340
Servicing LR1110-703B, -704, LR1125-701
12 V.
Terminals: L-S



235144

Replacing L185G-4340 
Servicing LR185-701C, -702
12 V.
Terminals: L-S

Replacing HITACHI

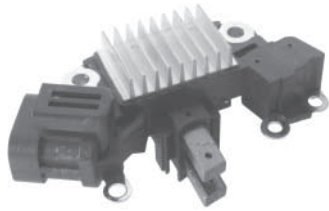

235145

Replacing LR170-758, -764, LR180-766
12 V.
Field control unit



Regulator Parts



234274

Replacing TR1Z-257
Replacing LR190-501C, -501E, -513, -513B
12 V.
Terminals: L, S
I.C. regulator



131287 A

Replacing TR1Z-64
Replacing Cargo 132431, 132432, 133543, 133544
12 V.
Repair circuit w/ terminals B-S-R-L-F-E
New Era type: Cargo 136284



234908

Replacing LR160-729C
12 V.
Terminals: S - L - I - C - G
I.C. regulator



131528 A

Replacing TR1Z-46, 8 94223 9670
Replacing LR140-112
12 V.
Repair circuit w/ terminals R-S-B-F-E



130834 A

Replacing TR1Z-48, 23215-Q4602
Replacing Cargo 130831, 130832, 131529
12 V.
Repair circuit w/ terminals B-S-L-F-E

132292 A

Replacing TR 2Z-37, -49, 8 94156 5950
Replacing LR225-65P, -67P, -68B, -80, -403, -407, -408C, -409B, -410, -412C, -413E, LR235-58, -70, -401
24 V.
Repair circuit w/ terminals B-S-R-L-F-E

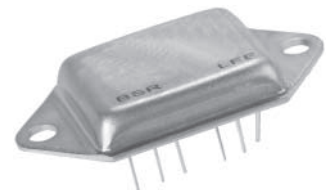

Replacing HITACHI

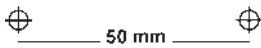

132433

Replacing TR 1Z-28
Servicing LR135-31, -32, -123,
 Yanmar marine
 12 V.
 Repair circuit w/ terminals B-S-L-F-E

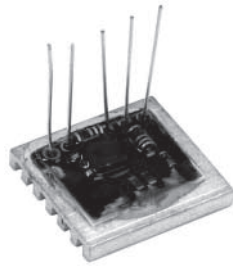

133248 A

Servicing L165-2315, -5315,
 23733-AA000
 12 V.
 Repair circuit w/ terminals B-S-L-F-E
 O.E. style only

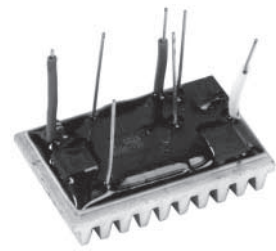

135025 A

Servicing L170-23152, Cargo 135024
 12 V.
 Repair circuit w/ terminals S-IG-L



132434 A

Replacing TR 1Z-34, -44, 5-81270004-0
Servicing LR120-15C, -16B, -22, -23,
 -34, LR135-58B, -86F, -91,
 Cargo 132429, 132430
 12 V.
 Repair circuit w/ terminals R-R-L-F-E

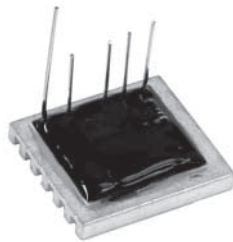

133249 A

Servicing L160-5315, L180-7315,
 L190-3315, -4315, 23133-F6100, -13E00
 12 V.
 Repair circuit w/ terminals E-F-T-L-S
 O.E. style only



135026 A

Replacing TR2Z-47, 23500-99008
Servicing LR215-23, -24, -50,
 LR225-84T, -85, -86B, -89, LR235-60C,
 -61C, -62, -68, -69, -72B, -76, -80
 24 V.
 Repair circuit w/ terminals R-R-L-F-E

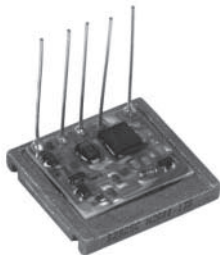

133247 A

Servicing L170-1315, 23133-04P01,
 Cargo 132992
 12 V.
 Repair circuit w/ terminals B-S-L-F-E

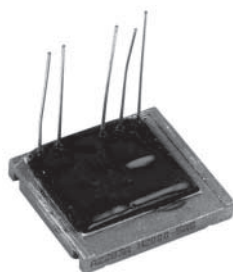

133250 A

Servicing L160-43154, 23133-58S00,
 Cargo 132991
 12 V.
 Repair circuit w/ terminals L-S-T-F-E



136284 A

12 V.
 Repair circuit w/ terminals B-S-R-L-F-E
 Same as Cargo 131287, but New Era type

Replacing HITACHI



231305

Replacing L135-13134
M5 x 33 mm
Screw set for regulators



233790 Std pkg 25

Servicing LR150-438B, -439B,
LR155-418B, -419B, LR160-446, -446B,
-446C, -446E, LR170-415, -415B, -415C,
-419, -419B, -420, -420B, -422, -427
M5 x 47.5 mm, 12 mm thread
Screw for regulator

Rectifiers



130618

Replacing L125-8320, 23230-E3200
Servicing LT125-06, LT130-72,
LT135-13, -20, -30, -35
50 Amp. 6 diodes, w/o diode trio
3 terminals

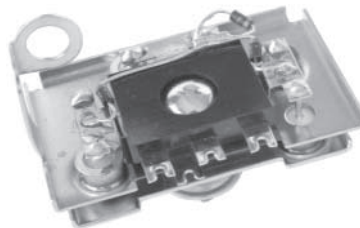

131548

Replacing L150N-13201, 23230-P2501
Servicing LR150-31, -36, -52, -53, -58
50 Amp. 6 diodes, w/ diode trio



131549

Replacing L135N-13201, 23230-B9800
Servicing LR150-30
50 Amp. 6 diodes, w/ diode trio



131598

Replacing L150-13203, 23230-06500
Servicing LR160-78, -78B, -82, -84, -93
50/70 Amp. I.C. alternators
Copper heat sink
O.D. 118 mm, 6 diodes, w/ diode trio
Version w/ strap terminal: Cargo 139347



131599

Replacing L150-13204, 23232-W1700
Servicing LR150-135E, -136E, -147C,
-162
Copper heat sink
O.D. 111 mm, 6 diodes, w/ diode trio



131600

Replacing L150-13206, 23230-W7101
Servicing LR150-186C, LR160-412
Copper heat sink
O.D. 111 mm, 6 diodes, w/ diode trio

Replacing HITACHI



131601

Replacing L150M-13202, 23137-Y7502
Servicing LT140-106
 O.D. 111 mm, 6 diodes, w/o diode trio



132050

Replacing L150-13208, 23230-W1501
Servicing LT150-114B, LT160-88, -89, -89B
 O.D. 114 mm, 6 diodes, w/o diode trio



132098

Replacing L170-6320, 23230-51S00
Servicing I.C. alternators w/ internal fan LR160-715, LR170-717
 O.D. 100 mm, 6 diodes, w/ diode trio

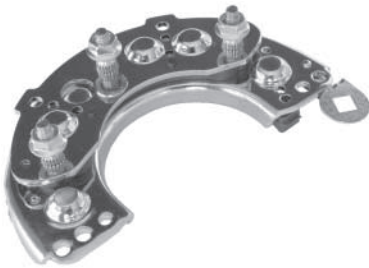

131602

Replacing L150-13205, 8 94223 9680
Servicing LT150-154, -196, Isuzu, Copper heat sink
 O.D. 110 mm, 6 diodes, w/o diode trio



132051

Replacing L150-13202, 23230-P4505
Servicing LT150-52, -102, -113, -113B, -123, -123B, -129
 Copper heat sink
 O.D. 111 mm, 6 diodes, w/o diode trio



132099

Replacing L180-2320, 23230-10E05
Servicing LR170-713, -721, LR180-704, -715, LR190-704
 O.D. 112 mm, 8 diodes, w/ diode trio
 B+ terminal M6 x 46 mm
HD version: Cargo 138125



131603

Replacing L150-43203, 23232-02N09
Servicing LR150-139P, -401, -401C, -402, -402C, -403, -423, L160-414
 Copper heat sink
 O.D. 111 mm, 6 diodes, w/ diode trio



132053

Replacing L160-23201, 23232-W1705
Servicing LR160-64, -67G, -67H, -92C, -96C, -107B, -108B, -114B, -134, -135, -143, -144, -146, -147E, -147F, -148E, -148F, -152E, -152F
 O.D. 118 mm, 6 diodes, w/ diode trio



132406

Replacing L135-3320
Servicing LR135-74, -74B, -102, -105, -106, -126, -130, -136, LR140-130
 O.D. 100 mm, 6 diodes, w/ diode trio

Replacing HITACHI



132408

Replacing L135Y-1302
Servicing LR135-31, -41B
 Yanmar marine
 Positive

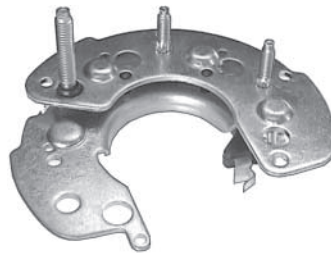

133262

Replacing L170-1320, 23230-05P01
Servicing LR170-701B, -702B
 70 Amp.
 O.D. 104 mm, 6 diodes, w/ diode trio

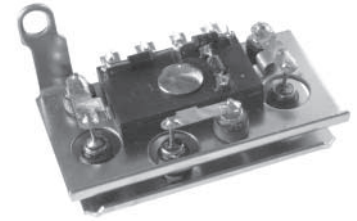

134386

Replacing 23230-E3200
Servicing LR150-02, -11, -11A
 50 Amp.
 6 diodes, 4 terminals, w/ diode trio



132410

Replacing L130M-1330, L140-23201
Servicing LT140-109B, -109C
 Isuzu
 O.D. 100 mm, 6 diodes, w/o diode trio



133377

Replacing L165-6320, 23830-AA020
Servicing LR165-704B, -707B
 O.D. 100 mm, 8 diodes, w/ diode trio



135035

Replacing L165-3320, 23830-AA000
Servicing LR165-704
 O.D. 100 mm, 6 diodes, w/ diode trio
 B+ terminal M6 x 28 mm



132412

Replacing L150-93201
Servicing Mazda 2200 E Diesel
 O.D. 111 mm, 6 diodes, w/ diode trio



133764

Replacing L145-2320, 23830-KA010
Servicing LR145-701E
 O.D. 87 mm, 6 diodes,
 W/ diode trio and condenser



135036

Replacing L170-2320, 23230-02E00
Servicing LR170-709, -710
 O.D. 104 mm, 6 diodes, w/ diode trio
 B+ terminal M6 x 28 mm

Replacing HITACHI



135037 HD

Replacing L160-23202, 23230-57J03
Servicing LR160-422B, LR170-402, -404, -406B
 O.D. 118 mm, 6 diodes, w/ diode trio
 Copper heat sink



135040

Replacing L180-13202, 23230-64J00
Servicing LR180-725
 O.D. 103 mm, 7 diodes, w/ diode trio



135466

Replacing L135-6320
Servicing LR135-107, -108, LR140-132, -133
 O.D. 100 mm, 6 diodes, w/ diode trio



135038

Replacing L170-33202, 23830-AA040
Servicing LR170-732, -732B, -732C,
 O.D. 103 mm, 8 diodes, w/o diode trio



135246

Replacing L160-33202
Servicing LR150-197, -B, LR160-140B, -151
 O.D. 111 mm, 6 diodes, w/ diode trio
 B+ terminal M6 x 32 mm



135757

Replacing L140-53201
Servicing LR140-120E, -131, -131B
 O.D. 100 mm, 6 diodes, w/ diode trio



135039

Replacing L170-23203, 23230-50Y06
Servicing LR170-738, LR180-736C,
 O.D. 103 mm, 8 diodes, w/o diode trio

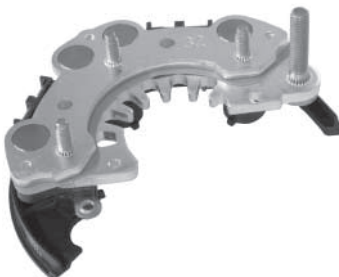

135318

Replacing L165G-2320, L170G-2320
Servicing LR165-709, LR170-738C, LR180-725C
 O.D. 103 mm, 8 diodes, w/o diode trio
 B+ terminal M6 x 26 mm



136650

Replacing L170-43202, 23230-12G01
Servicing LR170-734, -739
 O.D. 103 mm, 6 diodes, w/ diode trio
 B+ terminal M6 x 36 mm

Replacing HITACHI

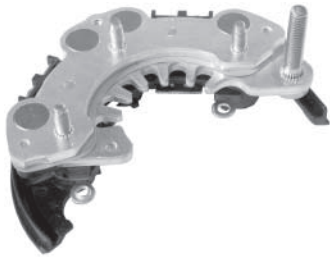

136976

Replacing L170G-1320
Servicing LR170-738B
 O.D. 103 mm, 8 diodes, w/ diode trio



138125 HD

Heavy duty version of 132099
 70 Amps Diodes
 O.D. 113 mm, 9 diodes, w/ diode trio
 B+ terminal M6 x 30 mm



138616

Replacing L160-33201
Servicing LR160-702B, -703B
 O.D. 97 mm, 6 diodes
 B+ terminal M6 x 14 mm



137015

Replacing L150-43202
Servicing LR155-502B, -502C, -502E, -503E, -504
 O.D. 100 mm, w/ diode trio
 Copper heat sink

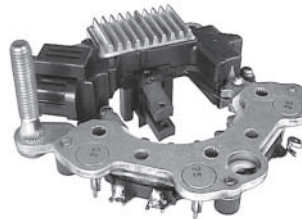

138190

Replacing L170G-6308
Servicing LR170-505
 12 V.
 O.D. 115 mm, 6 diodes, w/ regulator
Regulator: Cargo 139980
Rectifier only: Cargo 230094



138617

Replacing L190G-33201
Servicing LR170-502C, LR190-505E, -511, -511B
 O.D. 118 mm, 6 diodes
 W/ terminal W
 B+ terminal M5



137187

Replacing L225-3320
Servicing LR155-20, -B, -29, -30B, -C, LR225-71
 O.D. 111 mm, w/ diode trio



138615

Replacing L180G-8320
Servicing LR180-501, -501B, -501C
 O.D. 119 mm, 8 diodes



138695

Replacing L165-8320
Servicing LR165-708
 O.D. 112 mm, 6 diodes, w/ diode trio
 B+ terminal M6

Replacing HITACHI



138718

Replacing L1110G-4320, L1125G-2320
Servicing LR1110-705, LR1125-702B
 O.D. 119 mm, 8 diodes
 B+ terminal M6



139347

Replacing L150-13203, 23230-06500
Servicing LR160-78, -78B, -82, -84, -93
 50/70 Amp. I.C. alternators
 Copper heat sink
 O.D. 118 mm, 6 diodes, w/ diode trio
 Version w/o strap terminal: Cargo 131598



230094

Servicing LR170-505, -505B,
 Opel
 B+ terminal M8 x 38 mm
 Regulator/Rectifier: Cargo 138190



138732

Replacing L170G-13201, -53203
Servicing LR170-743, -745, -746B,
 -746C, -746E, -746F, -746G, -746H, -748,
 -750, -750B, -750C, -750E
 O.D. 115 mm
 B+ terminal M8

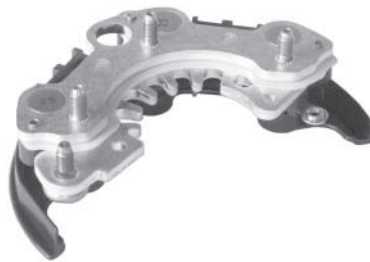

139464

Replacing L160G-1320
Servicing LR160-724
 O.D. 103 mm, 6 diodes



230478

Replacing L160-23203
Servicing LR160-109C, -167
 O.D. 118 mm, w/ diode trio
 B+ terminal M6



139172

Replacing L180-93201, L190-4320
Servicing LR180-724, LR190-706, -707,
 -707B
 O.D. 113 mm, 6 diodes, w/ diode trio
 B+ terminal M6



139579

Replacing L170G-93201
Servicing LR170-738E
 O.D. 103 mm, 8 diodes, w/ diode trio
 B+ terminal M6



230662

Replacing L180G-43201, -73203, -83202
Servicing LR160-727, LR180-741, -B,
 -C, -H, -744
 O.D. 102 mm

Replacing HITACHI



230865

Replacing L190G-33202
Servicing LR190-719B, -720B
 O.D. 103 mm, 8 diodes, w/o diode trio
 B+ terminal M6 x 33 mm



231554

Replacing L170G-6320
Servicing LR170-739B, LR235-702
 O.D. 103 mm, 6 diodes, w/o diode trio
 B+ terminal M6 x 36 mm



231726

Replacing L135-13203
Servicing LR120-16B, -23, LR125-34, LR135-34, -61B, -86, -86F, -95, -95B,
 O.D. 100 mm, w/ diode trio
 B+ terminal M5 x 26 mm



231081

Replacing L190G-73204, L1100G-5320
Servicing LR1100-501, -501B
 O.D. 118 mm, 8 diodes, w/o diode trio
 W/ terminal W
 B+ terminal M8 x 41 mm



231614

Replacing L225-5320
Servicing LR225-84, -84T, -85, -88, -89, -90, -91
 O.D. 111 mm, 6 diodes, w/o diode trio
 B+ terminal M6 x 20 mm



232072

Replacing L150-73202
Servicing LR150-703
 O.D. 95 mm, 6 diodes (50 Amp.),
 w/ diode trio
 B+ terminal M6



231442

Replacing L160G-9320, -33202, -53201
Servicing LR160-728, -728B, -728C, -728E, -732, -732B, LR225-702, LR235-705
 O.D. 102 mm, 8 diodes (35 Amp.),
 w/o diode trio
 B+ terminal M8



231621

Replacing L145-4320
Servicing LR145-701GA, -GB
 O.D. 86 mm, 6 diodes, w/ diode trio



232073

Replacing L170G-8320, -73201
Servicing LR170-417B, -C, -E, -F
 O.D. 118 mm, 6 diodes, w/ diode trio
 B+ terminal M6

Replacing HITACHI



233512

Replacing L1110-1320
Servicing LR1110-701, -702
 O.D. 119 mm, 8 diodes, w/ diode trio
 B+ terminal M8 x 45 mm



233606

Replacing L190G-73205
Servicing LR190-734, -734B, -734C, -734E, -734G
 O.D. 114 mm, 6 diodes
 B+ terminal M8 x 42.4 mm



233705

Replacing L1125G-7320
Servicing LR1125-702, -703C, -703E
 O.D. 119 mm, 8 diodes
 B+ terminal M8 x 13 mm

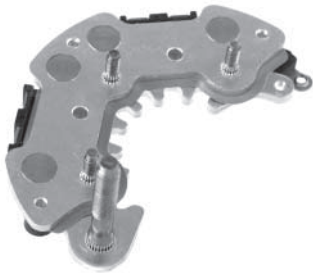

233513

Replacing L1110G-3320
Servicing LR1110-701B, -703B
 O.D. 119 mm, 8 diodes, w/o diode trio
 B+ terminal M8 x 45 mm



233620

Servicing LR170-509C, -509E, -509F, LR1100-502E, -502F, -502G, -502J
 O.D. 114 mm, 8 diodes, w/o diode trio
 B+ terminal M8 x 40 mm



234027

Replacing L1110G-8320
Servicing LR1110-709B
 O.D. 119 mm, 8 diodes



233514

Replacing L170-7302, L170G-73202
Servicing LR170-715, -715B, -716, -716B
 O.D. 100 mm, 8 diodes, w/ diode trio
 B+ terminal M6 x 22 mm



233639

Replacing L190-1320, -3320, -5320
Servicing LR190-702B, -702C, -703B, -704, -704B, -708, -708C, -711
 O.D. 113 mm, 8 diodes, w/ diode trio
 B+ terminal M6 x 46 mm



234277

Servicing LR140-708, -708C
 Honda Gold Wing
 O.D. 86 mm, 6 diodes

Replacing HITACHI



234312

Replacing L190G-33204
Servicing LR185-701C
 O.D. 115 mm, 8 diodes



234577

Replacing L180-716
Servicing LR180-716
 O.D. 100 mm, 8 diodes, w/ diode trio
 B+ terminal M6 x 33 mm



234828

Servicing LR190-743
 O.D. 114 mm, 8 diodes
 B+ terminal M6 x 35 mm



234315

Replacing L190G-43205
Servicing LR190-725F, -732C, -737B, -737E
 O.D. 115 mm, 8 diodes



234646

Replacing L140-73202
Servicing LR140-419T, -421, -421T, -422E, -422T, LR225-412C, -412S, -412T, -413E, -413S, -413T, -414, -414F, -414S, -414T, LR235-403E, -403S, -403T, -404C
 O.D. 118 mm, 8 diodes, w/ diode trio



234829

Servicing LR190-744
 O.D. 114 mm, 8 diodes
 B+ terminal M6 x 35 mm



234576

Replacing L180-23201, -23202
Servicing LR180-711B, -711E, -712, -712B, -714, -714B
 O.D. 100 mm, 8 diodes, w/ diode trio
 B+ terminal M6 x 36 mm



234809

Replacing L190G-8320
Servicing LR190-505C
 O.D. 118 mm, 6 diodes
 B+ terminal M6 x 38 mm



234909

Servicing LR160-729C
 O.D. 114 mm, 6 diodes
 B+ terminal M6 x 35 mm



Replacing HITACHI

Rectifier Parts



135257
Servicing L150-13203, -13206,
 L160-6320, Cargo 131598, 131600,
 131603, 132054
 111 x 118 mm
 Insulator for diode trio



137206
Servicing LR160-707, -708
 O.D. 115 mm
 Disc

235226

Replacing L190G-13205
Servicing LR190-747, -752
 O.D. 102 mm, 8 diodes



136331 Std pkg 10
Servicing LR160-715, LR165-707
 Insulator for diode trio



138226 Std pkg 5
Replacing L170-1350
Servicing LR170-701, -701B, -701E, -702B
 O.D. 113 mm
 Disc

235315

Replacing L160G-33202
Servicing LR160-728E, -728F
 O.D. xx mm, 6 diodes



135345
Replacing L190-1350, 23163-V4360
Servicing LR170-721B, LR190-702C,
 -704B, -708C, -711
 O.D. 131 mm
 Disc



138742
Replacing L170G-3350
Servicing LR170-502C, -504, -B, -505E,
 -511, -B, -512B, -C, -513, -B, -515, -B
 O.D. 127 mm
 Disc



136027
Replacing L170-4350
Servicing LR165-704B
 O.D. 113 mm
 Disc



139304
Replacing L170-3350, -3550
Servicing LR170-714, -715, -716, -717,
 O.D. 113 mm
 Disc

Replacing HITACHI



230282

Servicing LR170-505, -505B
O.D. 118 mm
Disc



234963

Servicing LR170-509C, -509E, -509F, -509G, -509H, LR1100-502E, -502F, -502G, -502H, -502J, -502K
O.D. 130 mm, I.D. 38 mm
Disc



233324

Servicing LR170-713, -721, LR180-704, LR190-704, -704B, -709, -709B, -711
M6 int. / M4 ext.
B+ terminal



231619

Replacing L140-2355
Servicing LR140-703, -704, -705, -713, -714, -714B, -719, LR145-701GA, -702, -702B, -703, -705, -706, -707, -708, -708B
O.D. 100 mm
Disc



235016

Servicing LR1100-703, -711, -711B, -725B
O.D. 129.5 mm
Disc



233325

Servicing LR160-727, LR180-509, -741H, -744, LR1125-702, -702B
M6 x 17 mm,
KNURL O.D. 8.5 mm
B+ terminal



234264

Servicing LR190-734E
O.D. 130 mm
Disc



235174

Servicing LR160-728E, -728F, LR165-714, LR170-764, LR180-762, -768, LR190-747, -752
O.D. 114.5 mm, I.D. 30 mm
Disc



233326 Std pkg 5

Servicing LR170-745, -748, -748B, LR190-729
M8 x 46.5 mm
KNURL O.D. 8.5 mm
B+ terminal



234837

Replacing L180G-1350
Servicing LR180-501, -501B, -501C
O.D. 130 mm
Disc



136026 Std pkg 2

Replacing L150-3313
Servicing LR165-704B
M4/5 x 40 mm
Stud

Also see Diode Chapter
page 780

Replacing HITACHI

Diodes



134494 Std pkg 10
Replacing Q05B-00, 23231-65002
 25 Amp. 200 V.
 12.7 mm press fit
 Negative



136253 Std pkg 10
 40 Amp. 400 V.
 20 mm lead
 11.5 mm press fit
 Late model for internal fan alternator
 Positive



233445 Std pkg 10
 50 Amp. 100 V.
 1.5 x 19 mm lead
 11.5 mm press fit
 Positive



134495 Std pkg 10
Replacing Q06B-00, 23232-65002
 25 Amp. 200 V.
 12.7 mm press fit
 Positive



136254 Std pkg 10
 40 Amp. 400 V.
 20 mm lead
 11.5 mm press fit
 Late model for internal fan alternator
 Negative



233446 Std pkg 10
 50 Amp. 100 V.
 1.5 x 19 mm lead
 11.5 mm press fit
 Negative



135152 Std pkg 10 **A**
 35 Amp. 400 V.
 5/16", Tin can, 26 mm lead
 Positive



233443 Std pkg 10
 35 Amp. 200 V.
 1.5 x 19 mm lead
 11.5 mm press fit
 Positive



135153 Std pkg 10 **A**
 35 Amp. 400 V.
 5/16", Tin can, 26 mm lead
 Negative



233444 Std pkg 10
 35 Amp. 200 V.
 1.5 x 19 mm lead
 11.5 mm press fit
 Negative

Replacing HITACHI

Slip Rings



133410 Std pkg 5 **A**
O.D. 35 mm, Shaft 17 mm, L. 28 mm



135054 Std pkg 5 **A**
Servicing LR170-715B, 716B, 717
O.D. 27.5 mm, Shaft 14 mm, L. 29.5 mm



137315 Std pkg 5
Servicing LR160-154
O.D. 32.4 mm, Shaft 17 mm, L. 29.4 mm



137571
Servicing LR165-708C, -709, -732
O.D. 27.2 mm, Shaft 14 mm, L. 32.3 mm



138439 Std pkg 5
O.D. 24.5 mm, Shaft 14 mm,
L. 29.7/32.8 mm



138440 Std pkg 5
Servicing LR150-401, -402
O.D. 32.5 mm, Shaft 17 mm, L. 27.5 mm



233235 Std pkg 5
O.D. 26.6 mm, Shaft 13.9 mm, L. 27.5 mm

Brush Boxes



130705
Replacing L150-13502, 23133-U0101
Servicing LT130-83, LT135-13, -16,
-17B, -21, -22, -24, -26, LT140-90, -95,
LT150-05, -06, -10, -10B, -12, -13, -16,
-17, -18, -19, -21, -27B, LT160-19B, -20
12 V. Complete w/ brushes

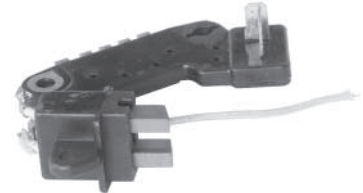

132089
Replacing L135N-13301, 23135-B9800
Servicing LR135-44, LR138-01, -72R,
LR150-35, -36, -51, -53, -58
12 V. Complete w/ brushes

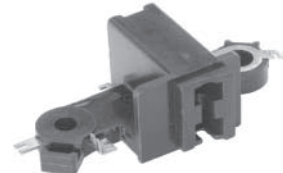

132426
Replacing L150-43303, 23135-V6600
Servicing LR140-130P, -402, -406, -408,
-410, -410B, -410BA, -410F, -410G, -411
-411B, -411BA, -411F, -411G, -415, -415B
-419T, -421, -422E, -422T, -423, -423F
12/24 V. Complete w/ brushes

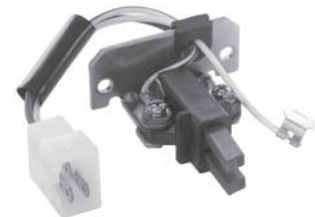

132428
Replacing L150-53302, L150M-13301
Servicing LT140-106, -106C, LT150-57,
-106, LT155-08, LT225-60C
12 V. Complete w/ brushes

Replacing HITACHI

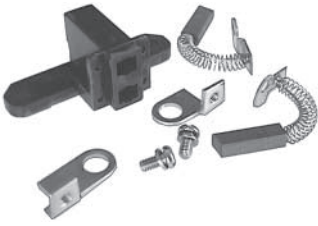

133327

Replacing L150-43301, 23135-W1700
Servicing LR140-112E, -119, -124C, -125B, -125C, -130B, LR150-135, -135E, -136E, -137B, -147C, -148C, -157B, -162, -193, -201, -201B, -202, -203, -204, -205
 12 V. Complete w/ brushes



135276

Replacing L170-3325, 23733-AA020
Servicing LR170-732, -732B, -732C
 12 V. Complete w/ brushes

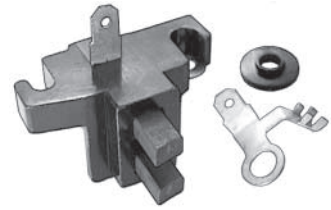

136332

Replacing L135N-1300, -1301
Servicing LT135-24B, -35C, -38C, -68, -73B, -81, -89
 12 V. Complete w/ brushes

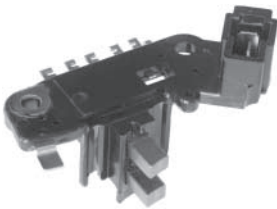

133536

Replacing L160-93301
Servicing LR160-121, -124, -170, -171
 12 V. Complete w/ brushes



135347

Replacing L180G-2330, 23133-85L00
Servicing LR165-708, -708C, -708E, LR170-738C, -738E, LR180-731B, -731C, -735, -738, -738B, LR190-715B, -715C, -715E, -722, -722B
 12 V. Complete w/ brushes



137085

Replacing L150-93303
Servicing LR155-502, -503, -504
 12 V. Complete w/brushes

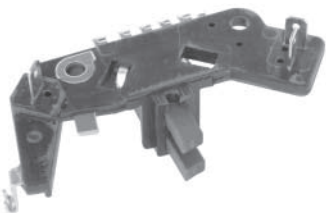

135067

Replacing L160-23301, 23135-V0101
Servicing LR160-82, -82B, -84B, -116, LR170-02B
 12 V. Complete w/ brushes



135348

Replacing L180-3330, 23133-64J00
Servicing LR160-723, -723B, LR170-734B, -739, LR180-725, -729
 12 V. Complete w/ brushes



137540

Replacing L160-63302
Servicing LR150-218, -221, LR160-151, LR170-22, LR180-02
 12 V. Complete w/brushes

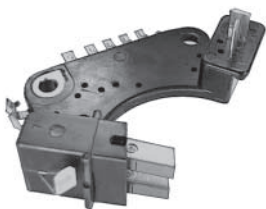

135446

Replacing L150-13304, -83303
Servicing LR150-15, -23, -25, -199, -200, LR155-15B, -15C, LR160-137, -138, -139
 12 V. Complete w/ brushes



135887

Replacing L150-33304
Servicing LR160-140, -154, LR225-86, -86B
 12 V. Complete w/ brushes



138371

Replacing L170G-4330
Servicing LR170-505, -506
 12 V. Complete w/brushes

Replacing HITACHI



138614

Replacing L180G-1330

Servicing LR160-724, LR170-739B, -740, -740B, -741, LR180-725C, -725E, -733, -733B, -734B, -734C, -736B, -737B, -737C, -739, LR190-716, -716B, -717, -717B
12 V. Complete w/brushes

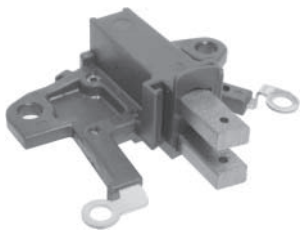

138719

Replacing L180G-4330, L190G-3330

Servicing LR160-728, -728C, -732B, LR170-756, LR180-743B, -746B, -748B, -749B, -749C, -749E, LR185-701C, -702
12/24 V. Complete w/brushes



138729

Replacing L165G-1330

Servicing LR165-709
12 V. Complete w/brushes



138733

Replacing L170G-3330, L180G-3330

Servicing LR160-727, LR165-711, LR170-743, -745, -746B, -746C, -746E, -746F, -752, LR180-745, LR190-729, -733, LR1100-704, LR1125-704
12 V. Complete w/brushes



138741

Replacing L170G-2330

Servicing LR170-501C, -502B, -502C, -503, -504, -504B, -504C, -505E, -505F, -511, -511B, -512B, -512C, -515, -515B, -LR1100-501, -501B
12 V. Complete w/brushes



230014

Servicing LR150-711, LR160-725, -726,

-726B, -738B, LR170-738, -738B
12 V. Complete w/ brushes



233254

Replacing L195G-1330

Servicing LR195-701
12 V. Complete w/ brushes

Brush Sets



140342 A

Replacing L150-13251, 23135-01B00
5 x 7 x 17 mm
12 V.



140343 Std pkg 10 A

Replacing L150M-13251, 23134-61S01
5 x 7 x 21 mm
12 V.



140344 Std pkg 10

Replacing 23135-14800
6 x 8 x 19 mm
12 V.



140380 A

Replacing L150-23251, 23134-Z9000
5 x 7 x 21 mm
12 V.

Also see Bearing Chapter
page 821

Replacing HITACHI



140575 Std pkg 10
Replacing L170-2325, 23142-19V01
 5 x 8 x 26 mm
 12 V.



140744 Std pkg 10
Replacing L160-1331, 23142-04P01
 6 x 7 x 18 mm
 12 V.



140818 Std pkg 10
Replacing L170-1325, 23142-58S00
 5 x 8 x 19 mm
 12 V.

Special Bearings



140233 Std pkg 5 **A**
Replacing 6900 BPL
 10/23 x 11 mm
 I.C. alternators w/ internal fan
 W/ snap ring
 S.R.E.



140235 Std pkg 5 **A**
Replacing 6000G, 6000HC, 23120-58S01
 10/27 x 11 mm
 I.C. alternators w/ internal fan
 W/ snap ring
 S.R.E.



140432 Std pkg 10 **A**
Replacing 23129-05E06, -16A00,
 6202 NC
 15/35 x 11 mm
 W/ snap ring



140434 Std pkg 10 **A**
Replacing 6202 NCD, 23129-05E06
 15/35 x 13 mm
 W/ snap ring



140989 Std pkg 5
Replacing 6201 NCD, -NCDP
 12/32 x 13 mm
 W/ snap ring



141012
Replacing 6202 LLBC3
 15/35 x 11 mm
 W/ 2 teflon tolerance rings



141062 Std pkg 5
Replacing 6302 NC
 15/42 x 13 mm
 W/ snap ring



141103
Servicing LR160-727, LR165-708C,
 LR170-745, -748, -757B, -758,
 LR180-725E, -734C, -741H, -742, -744,
 -751, LR185-701, LR1120-701
 10/27 X 11 mm
 W/ 2 teflon tolerance rings

Replacing HITACHI

Also see Pulley Survey
page 809

Fan & Pulleys



231519

Replacing L150-55001, LR170G-35001
Servicing LR150-135E, -147C, -162, -193, -203, -206, -211B, -212B, -431, -432
Fan: O.D. 134 mm, Bore 17 mm
Pulley: O.D. 80.2 mm, W. 17.5 mm
Pulley only: Cargo 230289



232600

Servicing LR135-58B, -74B, -86, -86B, -86C, -86F, -116
O.D. 125 mm, Bore 15 mm,
Fan



133936

Replacing L150-65004
Servicing LR150-151B
O.D. 64.5 mm, Bore 17 mm, W. 16.4 mm,
Single



233489

Replacing L135-6500
Servicing LT125-68
Fan: O.D. 125 mm, Bore 15 mm
Pulley: O.D. 73.3 mm, W. 29.8 mm,
Single, C-type belt



133343

Replacing L160-65003, 23150-16V01
Servicing LR160-715
O.D. 61.2 mm, Bore 17 mm, W. 21.1 mm,
4 grooves



134920

Replacing L150-25002, L155-3500, -4500
Servicing LR160-138
O.D. 71.7 mm, Bore 17 mm, W. 37.2 mm,
Double, B-type belt



233604

Replacing L150G-2500
Servicing LR160-412, -412F, -412G, LR160-440F, -441F, -449, -450
Fan: O.D. 133 mm, Bore 17 mm
Pulley: O.D. 73.8 mm, W. 27.8 mm,
Single, B-type belt



133348

Replacing L170-35001, 23150-D4400
Servicing LR170-715B
O.D. 60.3/62.6 mm, Bore 17 mm,
W. 47.7 mm, 4/6 grooves



135272

Replacing L160-6500, 23150-10G01
Servicing LR160-422, LR170-02
O.D. 73.4 mm, Bore 17 mm,
Single, B-type belt



234278

Replacing L190G-4500
Servicing LR180-504
Fan: O.D. 135 mm, Bore 17 mm
Pulley: O.D. 81.8 mm, W. 26.9 mm,
Single, C-type belt



133699

Replacing L150-55007, L225-9500
Servicing LR225-403
O.D. 79.2 mm, Bore 17 mm, W. 35.4 mm,
Double, B-type belt



135629

Replacing L160-75002, 23150-13E05
Servicing LR160-710
O.D. 69/74, Bore 15 mm, W. 32.8 mm,
Double

Also see Pulley Survey
page 809

Replacing HITACHI



136042

Replacing L180-65001
Servicing LR180-725C
O.D. 69 mm, Bore 17 mm, W. 31.4 mm,
6 grooves



136156

Replacing L150-85004, 23150-16A00
Servicing LR150-401, -401C, -402, -402C
O.D. 83.9 mm, Bore 17 mm, W. 20.4 mm,
Single, B-type belt



136959

Replacing L180G-4500, -65001
Servicing LR180-738, -738B, -746,
LR190-719, -722, -722B, -729
O.D. 69.3 mm, Bore 17 mm, W. 26.6 mm,
5 grooves



136117

Replacing L160-25001, 23150-57J00
Servicing LR160-67H, LR170-405, -417
O.D. 84.3 mm, Bore 17 mm, W. 19.1 mm,
Single, B-type belt



136157

Replacing L160-25004, 23150-02N09
Servicing LR170-407E, -408C, -412, -413
O.D. 79.5 mm, Bore 17 mm, W. 35 mm,
Double, B-type belt
For short shaft



136960

Replacing L160-45001
Servicing LR160-96C, -108B, -131
O.D. 93.5 mm, Bore 17 mm, W. 22.5 mm,
Single, C-type belt



136149

Replacing L170G-1500, 23150-54A01
Servicing LR170-404B
O.D. 83.8 mm, Bore 17 mm, W. 22.6 mm,
Single, B-type belt



136159

Replacing L160-75004, 23150-43G07
Servicing LR170-407T, -408T, -412T
O.D. 84 mm, Bore 17 mm, W. 37.3 mm,
Double, B-type belt
For long shaft



136961

Replacing L170-55002
Servicing LR170-732C
O.D. 54.7 mm, Bore 17 mm, W. 30.5 mm,
5 grooves



136155

Replacing L150-45001, 8 81222 0600
Servicing LR150-201B, -205B, -441
O.D. 81.7 mm, Bore 17 mm, W. 26.2 mm,
Single, C-type belt



136160

Replacing L165-1500, 23752-AA000
Servicing LR165-704B
O.D. 55 mm, Bore 17 mm, W. 23.5 mm,
4 grooves



137941

Replacing L170-65002
Servicing LR170-734B, -739, -739B
O.D. 76.4 mm, Bore 17 mm, W. 21.6 mm,
Single, B-type belt

Replacing HITACHI

Also see Pulley Survey page 809



138372

Replacing L170G-45002
Servicing LR170-505
 O.D. 80 mm, Bore 17 mm, W. 19.1 mm,
 Single, B-type belt



139308

Replacing L150G-1500
Servicing LR150-448, LR160-446
 O.D. 81.9 mm, Bore 17 mm, W. 27.2 mm,
 Single, C-type belt



230293 A

Replacing F-227628.5
Servicing LR1120-701
 O.D. 56.1 mm, Bore 17 mm, W. 41.6 mm,
 6 grooves, w/ Free wheel
Pulley tool: Cargo 210843



138720

Replacing L1110G-1810
Servicing LR190-729, -B, LR1100-703,
 -B, -704, -711, -B, -716, LR1110-705, -B
 O.D. 62.9 mm, Bore 17 mm, W. 29.4 mm,
 6 grooves



139309

Replacing L150-55005
Servicing LR140-410BA, -F, -G, -411BA
 O.D. 73.9 mm, Bore 17 mm, W. 27.9 mm,
 Single, B-belt type



230521

Replacing L170G-25003, F-228751
Servicing LR170-761B, LR190-745, -752
 O.D. 59.6 mm, Bore 17 mm, W. 38.3 mm,
 7 grooves, w/ Free wheel
Pulley tool: Cargo 210843



138735

Replacing L170G-85001
Servicing LR165-711, -B, LR170-743,
 -746B, -C, -E, -F, -G, -J, -750C, -E
 O.D. 59.8 mm, Bore 17 mm, W. 21.7 mm,
 4 grooves



139666

Replacing L170-75002
Servicing LR165-708, -708B, -708C,
 -708E, LR170-738, -738B, -738C, -738E,
 LR180-730, -735, -743, -743B
 O.D. 80.4 mm, Bore 17 mm, W. 25.1 mm,
 4 grooves



230720

Servicing LR1100-502E
 O.D. 60 mm, Bore 17 mm, W. 31.2 mm,
 6 grooves



139243

Replacing L170-15003
Servicing LR170-406B, -C, -F, -414B
 O.D. 93.8 mm, Bore 17 mm, W. 23.2 mm,
 Single, C-type belt



230289

Servicing LR150-135E, -147C, -162,
 -193, -203, -206, -211B, -212B, -431, -432,
 -438B, -439B, LR155-415, -416, -418B
 O.D. 80.4 mm, Bore 17 mm, W. 18.1 mm,
 Single, B-type belt
Part of Cargo 231519 (L150-55001)



230955

Replacing L190G-25001
Servicing LR180-749, -749B, -749C,
 -749E, LR190-734, -734B, -734C, -734E,
 LR1100-710, -710B
 O.D. 83.9 mm, Bore 17 mm, W. 26.3 mm
 Single, B-type belt

Also see Pulley Survey
page 809

Replacing HITACHI



230991

Replacing L165G-2500
Servicing LR165-709, -712, LR170-759
O.D. 54.8 mm, Bore 17 mm, W. 24.6 mm,
4 grooves



231108

Replacing L215-25004
Servicing LR135-125, -127, LR220-23,
-27, -27B, LR225-27B
O.D. 82 mm, Bore 15 mm, W. 24.1 mm,
Single, C-type belt



231114

Replacing L170G-1501
Servicing LR160-728, -B, -C, -E,
LR170-749B, -C, -E, -F
O.D. 83.8 mm, Bore 17 mm, W. 44.3 mm,
Double, B-type belt



231674

Replacing LR170G-7500
Servicing LR170-740, -740B, -752,
-752B, LR190-720, -720B, -733, -733B,
LR1100-708
O.D. 72.7 mm, Bore 17 mm, W. 36.4 mm
Double



233537

Servicing LR180-762, 23100-BU010
O.D. 60.2 mm, Bore 17 mm, W. 29.4 mm,
6 grooves



233989

Replacing L1100G-7500, F-232288.1
Servicing LR1110-713
O.D. 52.2 mm, Bore 17 mm, W. 39.7 mm,
6 grooves, w/ Free wheel
Pulley tool: Cargo 210843



238690

Replacing F-240113
Servicing LR1100-503, LR1100-503B,
LR1100-508
O.D. 59.82 mm, Bore 17 mm, W. 39.62 mm,
6 grooves, w/ Free wheel
Pulley tool: Cargo 230843



210843

Tool to be used for mounting and
dismounting of free wheel pulleys
Shaft L. 74 mm.

210948

As Cargo 210843, but
Shaft L. 114 mm.

Fan & Pulley Parts



134273 Std pkg 10

O.D. 21.6 mm, Bore 15.5 mm, Th. 5.9 mm
Spacer



136238 Std pkg 5

O.D. 22 mm, Bore 17 mm, Th. 9 mm
Spacer



Replacing HITACHI

Vacuum Pumps



134881

Replacing VP25-79004, 14650-16A00
Servicing LR150-401C, -402C,
 LR160-401C
 16 Splines



231419

Replacing VP25A-79003
Servicing LR140-419T, LR150-430C,
 -430T, -435, -435T, LR160-427C, -427T,
 LR170-408C, -408T, LR225-412C, -412T,
 LR235-404C, -404T, -405
 16 Splines



233602

Replacing VP25A-39002
Servicing LR170-404
 16 Splines



139830

Replacing VP30G-1900
Servicing LR170-404B, -404C, -421,
 -421B
 8 Splines



231444

Replacing VP50-3900
Servicing LR140-402, -403
 16 Splines

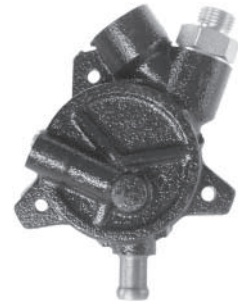

234849

Servicing LR170-509C, -509E, -509F,
 -509G, -509H, LR1100-502E, -502F,
 -502G, -502H, -502J
 8 Splines



231418

Replacing VP25A-39005
Servicing LR150-434, -441
 16 Splines



231974

Replacing VP25A-59007, VP30G-19003
Servicing LR170-417B, -417C, -417E,
 -417F, -502B, -502C, -504, -504B
 8 Splines



235170

Replacing VP30G-49003
Servicing LR170-505, 505B
 6 Splines

Replacing HITACHI

Vacuum Pump Parts

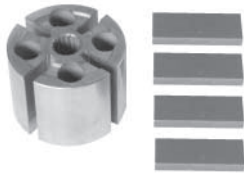

134394 A

Replacing VP50-1930, 14651-W2500
Servicing LR140-402, -408, -415B, -422T
 O.D. 52.2 mm, W. 39 mm, 16 splines
 Rotor kit



133277 A

Replacing VP25-19101, -19103
 5 x 13.8 x 25 mm
 Rotor vane set



135130 A

Replacing VP25-29471, 14675-R8800
Servicing LR140-130P, -410F, -411F, -421T, -423F, LR150-79H, -139P, -148C
 Valve set

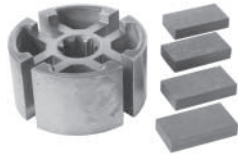

136904

Replacing VP25-49302, VP30G-2930
Servicing LR150-430S, -435S, -438B, -439B, -441C, -442, -449, -449B, LR160-427S, LR170-408S, -417F, -502C
 O.D. 49.3 mm, W. 25 mm, 8 splines
 Rotor kit



133279 A

Replacing VP50-1910
 5 x 15.2 x 39 mm
 Rotor vane set



135131 A

Replacing VP25-39471, 14675-V7200
Servicing LR140-415B, -419T, -422T, LR150-425B, -428T, -430T, LR160-422B
 Valve set

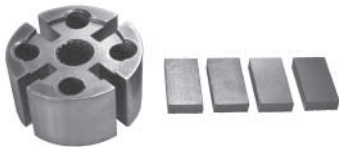

139964 A

Replacing VP25-19301, -29301
Servicing LR140-124C, -125B, -125C, -130P, -406, LR150-79H, -137B, -139P, -148C, -157B, -401, -401C, , LR155-16P
 O.D. 49.2 mm, W. 25 mm, 16 splines
 Rotor kit



231379

Servicing LR1100-502E
 4.9 x 14.4 x 31 mm
 Rotor vane set



136873 Std pkg 5 A

Servicing LR170-411B,C,D, LR170-420, -427
 M16-1.5 /M18-1.5
 Valve



139053

Replacing VP30G-1930
Servicing LR140-410, -B, -BA, -F, -G, -411, -B, -BA, -F, -G, -423, -F, -429B, -430, LR150-410C, -CA, -F, -G, -419B, -BA, -F
 O.D. 49.1 mm, W. 25 mm, 8 splines
 Rotor



135129 A

Replacing VP25-9947, 14675-60L00
Servicing LR160-417
 Valve set



233817

Servicing LR1100-502E, -502F, -502G, -502J, LR170-509C, -509E, -509F
 M18 x 15 mm, L. 30.9 mm
 Valve

Replacing HITACHI

Also see O-ring Survey page 854



139569 Std pkg 5
Replacing 2085-1701
 M10-1.5 / M12-1.5, L. 28 mm
 Nipple



080252 Std pkg 10 **A**
 M10-1
 Hollow screw

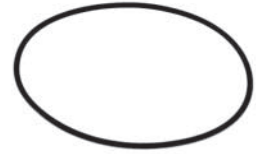

132659 Std pkg 5 **A**
Replacing 2084-0631
Servicing LR225-65, LR235-402
 61 x 2 mm
 O-ring



135453 **A**
Replacing VP25-59623, 14680-G5500
Servicing LR140-415B, -419T, -422
 For M18 hollow screw, 5 mm hose I.D.
 Ring nipple



080253 Std pkg 10 **A**
 M10-1.5
 Hollow screw



132660 Std pkg 5 **A**
Replacing 2084-0641
Servicing LR225-65, LR235-402
 25 x 2 mm
 O-ring



136874 Std pkg 5
Replacing VP25-99624
Servicing LR150-434, -441, -444B
 For M18 hollow screw, 5/10 mm hose I.D.
 Ring nipple



080256 Std pkg 10 **A**
 M16-1.5
 Hollow screw



134490 Std pkg 10 **A**
Replacing VP50-1915, 14688-W2500
 62 x 2 mm
 O-ring



134290 Std pkg 10 **A**
 M12-1.5
 Screw plug



080875 Std pkg 10
Replacing 3062-1231
 M16-1.5
 For 11 mm. hose I.D.



190806 Std pkg 100 **A**
Replacing 2116-1131
 10/16 x 1.0 mm
 Copper
 Sealing ring

Replacing HITACHI



190818 Std pkg 100 **A**
Replacing 2116-1501, -1502
 16/22 x 1.5 mm
 Copper
 Sealing ring



190820 Std pkg 100 **A**
Replacing 2116-1491
 18/20 x 1.5 mm
 Copper
 Sealing ring



191358 Std pkg 100 **A**
Replacing 2116-1511
 12/24 x 1.0 mm
 Copper
 Sealing ring



191489 Std pkg 100 **A**
 16/24 x 1.5 mm
 Copper
 Sealing ring

Repair Kits



231063
Servicing LR170-420

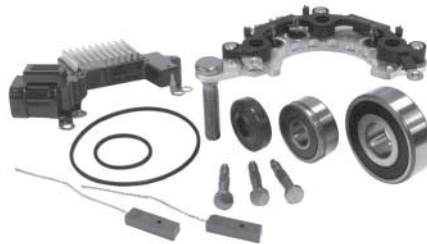

231064
Servicing LR170-505, -505B



233874
Servicing LR170-420
 Same as Cargo 231063, but
 w/ New Era I.C. regulator



135277 Std pkg 5
Replacing L170-1310, -4310, 23798-AA010
Servicing LR170-732C
 Terminal kit
Grommet only: Cargo 233279
B+ insulator only: Cargo 233298



135346
Replacing L170-2310, 23156-64J00
Servicing LR180-725
 Terminal kit
B+ insulator only: Cargo 137210 and 233304



137940
Replacing L150-33103
Servicing LR170-417B, -417C, -417E,
 -417F
 Terminal kit

Replacing HITACHI

Also see Oil Seal Survey page 856



138724

Replacing L190G-4310
Servicing LR180-743, LR190-725B, -E
 B+ terminal M8
 Terminal kit



139277

Replacing L150-83101
Servicing LR140-130P, -402, -406, -408
 M5 x 35 mm
 Terminal kit
B+ insulator only: Cargo 233300



Sundry Parts



132297 Std pkg 5 A

Replacing L150M-19221, 14658-36W00
Servicing LR225-65
 Alternators w/ vacuum pump
 15 x 32 x 7 mm
 Single oil seal S.R.E.



132661 Std pkg 5 A

Replacing L150-1922, 14658-44G00
Servicing LR235-402
 Alternators w/ vacuum pump
 15 x 32 x 7.5 mm
 Twin oil seal S.R.E.



138369 Std pkg 5 A

Replacing L150-2922
Servicing LR155-502B, -C, -E, -503, -504, -505, -506
 11 x 28 x 7.5 mm
 Oil seal



133499

Replacing L160-2317, 23611-05E06
Servicing LR140-415B, -421T, -422T, LR160-414, -417, -421C, -422B, -425B
 Terminal block



133727

Replacing L150-9317, 23611-29W00
Servicing LR140-130P, -402, LR150-403, LR155-16P, -408, LR225-65P, -67P, -403, -407
 Terminal block

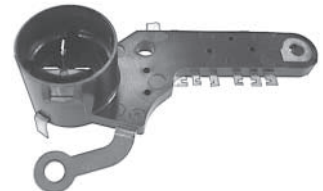

134834

Replacing L225-4317, 8-94156591-0
Servicing LR225-408E, -409B, -415B, -418B, LR235-401, -406, LR240-401, -402, -404C
 Terminal block

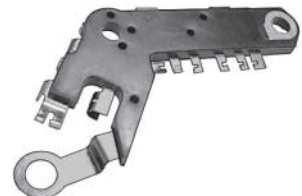

134877

Replacing L150-4317, 8-94237726-0
Servicing LR150-135E, -136E, -147C, -162, -193, -201B, -202, -203, -205B, -206, -211B, -212B
 Terminal block



135186

Replacing L150-23171
Servicing LR140-406, -410, -423, LR155-406B, -410F, -414F, LR160-412F, -440F, -441F
 Terminal block

Replacing HITACHI



135234
Replacing L150-1317, 23611-W1700
Servicing LR150-79H, -148C, -157B,
 LR160-67H, -92C, -96C, -107B, -108B,
 -144
 Terminal block



233327
Replacing L150-43171
Servicing LR160-151
 Terminal block



134999 A
 4P - 2P Coupler



135262
Replacing L150-7317, 23611-16A00
Servicing LR150-401C, -423B,
 LR160-401C
 Terminal block



233328
Servicing LR150-94B, -194B, -197B
 Terminal block



135000 A
 4P - 3P Coupler



137447
Replacing L160-3317
Servicing LR170-417B, -417C, -417E,
 -417F
 Terminal block



234061
Replacing L150-8360
Servicing LR150-136E, -147C, -162
 Lead wire



232778 Std pkg 5 **A**
 1P Coupler w/ lead wire (male)



137585
Replacing L150-73171
Servicing LR170-420, -422
 Terminal block



134996 A
 3P - 2P Coupler



135230
 Extension harness.

Replacing HITACHI



133252 A

Plug that converts early style alternator into late style w/ oval plug



135863

Replacing L225-2318
Servicing LR150-421C, -431, -432, -434B, -438B, -439B, LR155-415, -416, -418B
Capacitor



139580 Std pkg 5

Replacing L180G-2318
Servicing LR165-708, -708C, -708E, LR170-735B, -735C, -735E, -738, -738C, -738E, LR180-731B, -735, LR190-715B, -715C, -715E
Capacitor



135753

Servicing Opel
Plug w/wire
3 terminals



135956

Replacing L170-1318
Servicing LR160-715, LR170-714, -715B, -716B, -717, -719B, LR180-711B, -712
Capacitor



231077

Replacing L170G-2318
Servicing LR1100-501, -501B, LR170-501C, -502B, -502C, -503, -504, -504B, LR190-504C, -505C, -505E, -511, -511B, -512, -512B, -512C, -515, -515B
Capacitor



133765

Replacing L140-8810
Servicing LR140-701, LR145-701
Capacitor



138714

Replacing L170-6318
Servicing LR165-708B, -C, -E, LR170-738B, LR180-730
Capacitor



231078

Servicing LR170-505, -505B
Capacitor



135275

Replacing L170-4318, 23818-AA010
Servicing LR170-732C
Capacitor

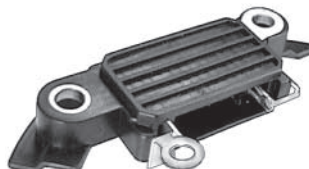

138731

Replacing L180G-1318, -3318
Servicing LR160-724, LR170-739B, -740, -740B, -741, LR180-725C, -725E, -733, -733B, -734B, -734C, -736B, -737B, -737C, -739, LR190-716, -716B, -717
Capacitor



138805

Servicing LR170-408C
Connector arm

Replacing HITACHI



138806

Servicing LR140-402
Connector arm



134663 Std pkg 10

O.D. 17.2 mm, I.D. 6 mm, W. 7.4 mm
B+ insulator



230033 Std pkg 5

Servicing LR170-743, -745, -746, -746B, -746C, -746E, -746F, -746G, -746J, -746K, -750, -750B, LR240-42, LR270-05
O.D. 27.5 mm, I.D. 8 mm
B+ insulator



139649

Servicing LR150-200, LR160-137, -138
Connector arm



134672 Std pkg 10

O.D. 21.9 mm, I.D. 6 mm, W. 12.2 mm
B+ insulator



230034 Std pkg 5

Servicing LR170-505, -505B, -506, LR1100-501, -501B
O.D. 28.0 mm, I.D. 8 mm
B+ insulator



231566

Servicing LR180-725
B+ Cover



135094 Std pkg 5

Replacing L170G-5310
Servicing LR170-504, -B
O.D. 22 mm, I.D. 6 mm
B+ insulator



230035 Std pkg 5

Servicing LR170-505, -505B, -506, LR270-06, -06B, LR1100-501, -501B
O.D. 15.8 mm, I.D. 9 mm, W. 5.9 mm
B+ insulator



233329 Std pkg 10

Servicing LR160-727, LT180-509, -741H, -744, LR185-701, -702, LR190-737B, -737E, LR1100-709B, LR1110-707C, -707E, -709, -709B, LR1125-702, -702B
B+ cover



137210 Std pkg 5

Servicing LR160-723, -723B, -724, LR180-725, -725B, -725C, -725E
O.D. 22 mm, Square hole 7 mm
B+ insulator
Part of terminal kit: Cargo 135346



230036 Std pkg 5

Servicing LR170-743, -745, -746, -746B, -746C, -746E, -746F, -746G, -746J, -746K, -750, -750B, LR240-42, LR270-05, LR290-02B, LR1100-701, -701B
O.D. 15.8 mm, I.D. 9 mm, W. 6.7 mm
B+ insulator

Replacing HITACHI



230403 Std pkg 5
O.D. 8.7/16 mm, I.D. 6.6 mm, W. 3.6 mm
B+ insulator



230404 Std pkg 5
O.D. 7.3/15.7 mm, I.D. 5.8 mm, W. 4.1 mm
B+ insulator



233298
I.D. 6 mm, W. 10 mm
Part of terminal kit: Cargo 135277
B+ insulator



233299 Std pkg 5
Servicing LR170-22, -701B, -702B, -713, -717, -721, -734B, -739, -739B, LR180-704, -724, LR190-704, -706, -709, -711, -714
I.D. 6 mm, W. 10 mm
B+ insulator



233300 Std pkg 5
Servicing LR120-15, -23, LR125-34, LR135-61B, -86F, -95, -115, -116, -127, -128, LR140-130P, LR150-94B, -98, -99
I.D. 6 mm
Part of terminal kit: Cargo 139277
B+ insulator



233301 Std pkg 5
Servicing LR150-98, -125B, -177, LR155-15B, LR160-82B, -109, -137, -138
I.D. 5 mm
B+ insulator



233302 Std pkg 5
Servicing LR170-727, -757B, -758, LR180-509, -741H, -742, -744, LR185-701, -702, LR190-724, -737B, LR1100-709, -709B, -711B, -716
I.D. 8 mm
B+ insulator



233303 Std pkg 5
Servicing LR160-727, LR170-757B, LR180-741H, -742, -744, LR190-724, -737B, -737E, LR1100-709, -711B, -716, LR1110-705, -705B, -705C, -705E, -705F
I.D. 8 mm, O.D. 27 mm
B+ insulator



233304 Std pkg 5
Servicing LR160-723, -723B, -724, LR180-725, -725B, -725C, -725E, -736B
Square hole 7 mm
Part of terminal kit: Cargo 135346
B+ insulator



137214
Replacing L170-1321
Servicing LR170-715B, -716B, LR180-716
Insulation kit



136767 Std pkg 10
Servicing L180G-1330, Cargo 135348
Insulator for brush holder

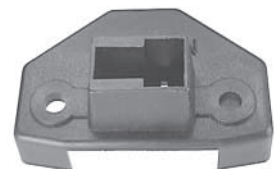

135125
Replacing L135N-1303, 23236-U0100
Servicing LT130-81, -89, LT135-24B, -35C, -38C, -54, -68, -73B
Cover for brush holder

Replacing HITACHI



136131 Std pkg 100
Melinex 0.2 mm
Insulator for diodes



231355 Std pkg 4
Replacing LR125-6801
M5 x 70 mm
Thru bolt



138422 Std pkg 5
Inside M10-1
Outside M10-1.5
Adaptor



231535 Std pkg 4
Replacing L170-1801
M5 x 70/95 mm
Thru bolt



233279 Std pkg 5
Part of terminal kit: Cargo 135277
Grommet



234959 
Servicing LR160-727B, -728E, -728F,
LR165-711B, -714, LR170-505B, -509C,
-509E, -509F, -509G, -509H, -511, -758,
-764, LR180-749, -749B, -749C, -749E
M5 x 29 mm, 7.5 mm thread
Bolt



231306 Std pkg 4
Replacing LR150-18015
M5 x 75 mm
Thru bolt

Replacing ISKRA

Rotors



130080

Replacing 16.905.223
Servicing 11.201.026, -030, -036, -037, -783, AAG1101, -1102, -1104, -1130
 12 V. 28 Amp.
 L. 147 mm, O.D. 73 mm, Shaft 17 mm



132338

Replacing 16.905.255
Servicing 11.201.027, -062, -372, AAG 1301, -1307, -1328
 12 V. 33 Amp.
 L. 155 mm, O.D. 73 mm, Shaft 17 mm



132340

Replacing 16.906.273
Servicing AAG 1302, -1310, -1311, -1314, -1315, -1338, -1321, -1339, -1327, -1340, -1341
 12 V. 33 Amp.
 L. 151 mm, O.D. 73.5 mm, Shaft 17 mm

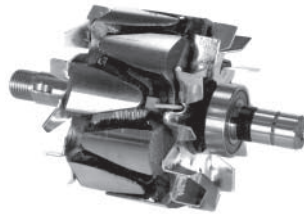

231116

Replacing 16.360.628
Servicing 11.201.440, -534, -666, -754, -769, AAK 5102, -5108, -5114, -5131, -5136
 12 V. 80 Amp.
 L. 155.2 mm, O.D. 93.3 mm, Shaft 17 mm



231397

Replacing 16.905.841
Servicing 11.201.219, -276, -325, -326, -329, -330, -331, -332, -334, -357, -457, AAK 4118, -4152, -4155, -4156, -4157
 12 V. 65 Amp.
 L. 155 mm, O.D. 89 mm, Shaft 17 mm



231473

Replacing 16.360.812
Servicing 11.201.598, -667, -670, -758, AAK 5112, -5115, -5117, -5132
 12 V. 75/85/95 Amp.
 L. 155 mm, O.D. 98 mm, Shaft 17 mm



234938

Replacing 16.361.303 
Servicing 11.201.498, -738, -830, AAK 5105, -5125, -5157
 12 V. 80 Amp.
 L. 155 mm, O.D. 93.3 mm, Shaft 17 mm

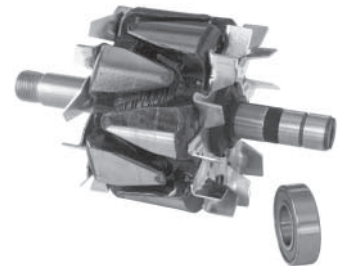

236703

Replacing 16.361.637 
Servicing 11.201.727, -875, -881, -989, 11.203.015, -098, AAK 5123, -5165, -5166, -5197, -5315, -5363
 12 V. 95 Amp.
 L. 151 mm, O.D. 93.3 mm, Shaft 17 mm

Replacing ISKRA

Stators



130099

Replacing 18.350.317
Servicing AAG0403, -1101, -1102, -1104, -1111, -1307, -1310, -1311, -1314, -1315, -1321, -1327, -1328, 11.201.017, -021
 12 V. 33 Amp.
 O.D. 107.9 mm, I.D. 73.8 mm, W. 21 mm



133081

Replacing 16.350.035, -070, -092
Servicing AAK1137, -1140, -1165, -1173, -1179, -1182, -1183, -1185, -1189, -1199, -3506, -3510, -3511, -3512, -3513, -3514
 12 V. 65 Amp.
 O.D. 125 mm, I.D. 89.6 mm, W. 25.7 mm



234948

Replacing 16.350.129 
Servicing 11.201.727, -791, -815, -875, -881, -886, -889, -963, AAK 5123, -5142, -5148, -5165, -5166, -5167, -5169, -5171
 12 V. 95 Amp.
 O.D. 125 mm, I.D. 94.5 mm, W. 31 mm



130101

Replacing 16.350.025
Servicing AAK1117, -1118, -1119, -1130, -1135, -1144, -1145, -1148, -1151, -1152, -1155, -1163, -1172, -1175, -1176, -1177
 12 V. 55 Amp.
 O.D. 125.3 mm, I.D. 89.3 mm, W. 24.1 mm



231053

Replacing 16.350.068
Servicing 11.201.440, -498, -597, -668, -675, -738, -754, -758
 12 V. 80 Amp.
 O.D. 124.9 mm, I.D. 93.8 mm, W. 32.1 mm



132351

Replacing 16.350.020
Servicing AAK1102, -1105, -1116, -1122, -1128, -1143, -1150, -1171, -1178, -1198, -1212, -1227, -1317, -1332, -3501, -3504
 12 V. 45 Amp.
 O.D. 124.8 mm, I.D. 88.9 mm, W. 23.5 mm



231474

Replacing 16.350.109
Servicing 11.201.534, -666, -667, -744, -769, -800, -889, -907, -992, -993, AAK 5108, -5114, -5115, -5127, -5136
 12 V. 70/80/85 Amp.
 O.D. 125.1 mm, I.D. 93.6 mm, W. 32 mm

Replacing ISKRA

Brackets D.E.



134397

Replacing 16.905.252
Servicing 11.201.027, -038, -062, -096, -353, -372, AAG 1301, -1302, -1307, -1311, -1327, -1328,
 W/ bearing



231051

Replacing 16.906.344
Servicing 11.201.440, -597, -598, -666, -667, -670, -675, -758
 W/ bearing



234939

Replacing 16.906.349
Servicing 11.201.498, -668, -738, AAK 5105, -5116, -5125
 W/ bearing



Brackets S.R.E.



134400

Replacing 15.130.165
Servicing AAG 1301, -1310, -1311, -1315 -1327
O-ring: Cargo 135357



231052

Replacing 16.906.348
Servicing 11.201.440, -498, -597, -598, -666, -667, -668, -670, -675, -738, -758
Bearing: Cargo 140273

Bracket Parts



139524

Replacing 16.905.736
Servicing 11.201.068, -143, -272, -276, -301, -305, AAK 1114, -1148, -4116, -4118, -4135, -4139
 Mounting bracket



230281

Replacing 16.905.302
Servicing 11.201.055, -070, -071, -075, -304, -306, -324, -325, -326, -327, -328, -329, -330, -331, -332, -334, -336, -343
 Mounting bracket
Bushing: Cargo 137461

Replacing ISKRA

Covers



131230

Replacing 16.905.322
Servicing AAK1102, -1105, -1114, -1117, -1118, -1119, -1122, -1143, -1144, -1145, -1146, -1148, -1152, -1157, -1182, -1183, -1185, 1324, -1325, -1326, -4118, -4134, -4135, -4139, -4141, -4168, -4169



231048

Replacing 16.905.322
Servicing 11.201.023, -042, -068, -071, -077, -078, -083, -101, -131, -132, -133, -143, -147, -155, -219, -220, -222, -276, -305, -307, -348, -349, -351, -396, -399, -400, -415, -505, -528, -530, -531, -566



231049

Replacing 15.420.838
Servicing 11.201.440, -498



231475

Replacing 15.421.124
Servicing 11.201.597, -666, -667, -668, -675, -758, -800, -881, -907, -925, -962, AAK 5114, -5115, -5118, -5132, -5145, -5166, -5174, -5181, -5185



233702

Replacing 16.420.271
Servicing 11.201.355, AAK4174, IA0355



234936

Replacing 15.421.130
Servicing 11.201.727, -738, -744, -815, -830, -857, -875, -952, -970, -976, -977, -978, -989, -992, -993, -997, -999, AAK 5123, -5125, -5127, -5148, -5157, -5161, -5165, -5182, -5189, -5193, -5194



234949

Replacing 15.421.377 
Servicing 11.201.534, 11.203.092, -093, -094, AAK 5108, -5358, -5359, -5360



234955

Servicing 11.201.257, -580, -583, -679, -931, -932 

Replacing ISKRA

Regulators



130657

Replacing 11.125.113, AER 1521
Servicing 11.201.094, -198, -208, -262, -370, -469, -476, -532, -535, -536, -554, -664, -763, -765, -766, -767, -768, -906
 12 V. For 6 diode alternators.



131811

Replacing 16.905.323, AER 1510
Servicing AAK
 12 V.
 Slip ring O.D. 32 mm

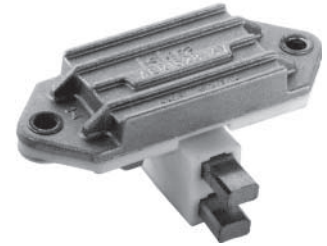

139513

Replacing 11.125.100, -122, AER 1514
Servicing 11.201.093, -112, -122, -145, -203, -204, -205, -207, -209, -210, -211, AAK 1128, -1135, -1140, -1150, -1171, -1172, -1173, -1177, -1178, -1179
 12 V.



130676

Replacing 11.250.049, AER 1503
 12 V.
 Slip ring O.D. 32 mm



132857

Replacing 11.125.029, -087, AER 1504, -1511
 24 V.
 Slip ring O.D. 32 mm



139514

Replacing 11.125.151, AER 1544
Servicing 11.201.355, -375, AAK 4174, -4186
 12 V.



130958

Replacing 11.251.120
 12 V.
 Slip ring O.D. 28 mm



134861

Replacing 11.125.149, AER 1543
Servicing 11.201.293, AAK 4127
 Lada Samara
 12 V.



139515

Replacing 11.125.053, -139, -177, AER 1505, -1560
Servicing 11.201.023, -042, -068, -070, -071, -077, -078, -083, -097, -101, -117, AAK 1102, -1105, -1114, -1116, -1117, -1118, -1119, -1122, -1130, -1133, -1137
 12 V.

Replacing ISKRA



231044

Replacing 11.125.165, 16.906.481
Servicing 11.201.666, -667, AAK 5114, -5115
 12 V.

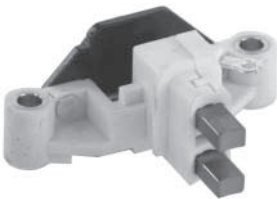

231045

Replacing 11.125.124, 16.906.352
Servicing 11.201.440, -498, -534, -769, AAK 5102, -5105, -5108, -5136
 12 V.



234648

Replacing 11.125.157, -180
Servicing 11.201.723, -745, -832, -938, 11.203.104, AAK1375, -1382, -3333, -3370, -4564
 12 V.

234935

Replacing 16.908.151 
Servicing 11.201.675, 11.203.016, -017, AAK 5118, -5315, -5316
 12 V.



234937

Replacing 16.908.964 
Servicing 11.203.110, -113, -114, -115, -204, -248, AAN 5127, -5130, -5131, -5132, -5156, -5166
 12 V.



236702

Replacing 16.908.866 
Servicing 11.203.094, -098, AAK 5360, -5363
 12 V.

Regulator Parts



132578 Std pkg 5
Replacing 15.420.028
 Gasket for regulator

Replacing ISKRA

Rectifiers



130597

Replacing 16.905.212
Servicing 11.201.017, -026, -030, -036, -037, AAG0403, -1101, -1102, -1103, -1104



132670

Replacing 16.905.254
Servicing AAG 1301, -1302, -1310, -1311, -1315
 B+ terminal M6
 For alternators with sealed slip ring space

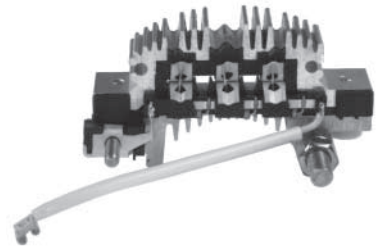

139518

Replacing 16.905.654
Servicing 11.201.122, -145, -210, -211, -244, -245, -257, -510, -529, -611, AAK 1140, -1150, -1178, -1179, -1198, -1199, -3510, -3578, -3588, -4106

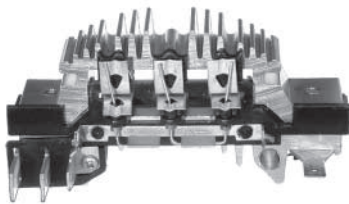

131135

Replacing 16.905.321
Servicing AAK1102, -1105, -1114, -1117, -1118, 1119, -1122, -1133, -1143, -1144, -1145, -1146, -1148, -1152, -1157, -1182, -1183, -1185, -1324, -1325, -1326, -3511
 W/ diode trio



139516

Replacing 16.905.613
Servicing 11.201.021, AAG 0702



231050

Replacing 16.903.314
Servicing 11.201.440, -490

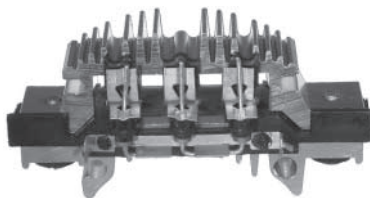

131698

Replacing 16.905.561, -667, -947
Servicing AAK1111, -1128, -1135, -1137, -1163, -1165, -1175, -1177, -1181, -1189, -1193, -1317, -3506, -3507, -3522, -3528
 W/ HD diode trio

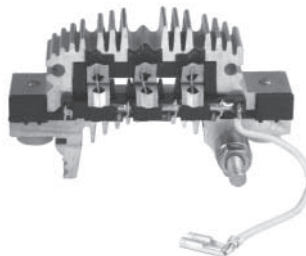

139517

Replacing 16.905.298
Servicing 11.201.055, -070, -102, -146, -273, -306, -480, -481, -557, -570, -571, AAK 1110, -1116, -1151, -1301, -1314, -1338, -1339, -1352, -1378, -4140, -4509, -4518

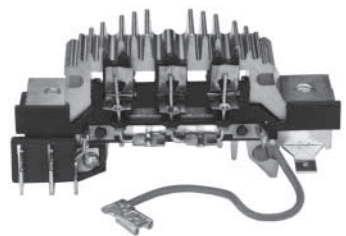

231363

Replacing 16.906.614
Servicing 11.201.470, -706, -707, -728, -729, -810, -811, -873, AAK 1333, -3310, -4567, -4568, -4574, -4575, -4598, -4599

Replacing ISKRA



231472

Replacing 16.903.507
Servicing 11.201.597, -666, -667, -675, -758, AAK 5114, -5115, -5118, -5132



236701

Replacing 16.902.556 
Servicing 11.203.016, -017, -098, -099, AAK 5315, -5316, -5363, -5364

Slip Rings



133401 Std pkg 10 
 O.D. 32 mm. Shaft 17 mm, L. 22.3 mm
 W/ 1.8 mm copper



133402 Std pkg 10 
 O.D. 28 mm. Shaft 17 mm, L. 22.1 mm
 W/ 1.8 mm copper



234940

Replacing 16.902.097 
Servicing 11.201.727, -791, -857, -875, -952, -989, -997, -999, 11.203.004, -005, -006, -007, -011, -012, -024, -030, -186, AAK 5123, -5142, -5161, -5165, -5182, -5197, -5199, -5304, -5305, -5306, -5307



232854
Servicing 16.360.628
 O.D. 15.7 mm. Shaft 7 mm, L. 52 mm



234950

Replacing 16.902.040 
Servicing 11.203.092, -093, -094, AAK 5358, -5359, -5360

Replacing ISKRA

Also see Bearing Chapter page 821

Brush Boxes



130938

Replacing 16.905.114
Servicing 11.201.021, AAG 0702
 12 V. Complete w/ brushes

Brush Sets



JX32 2 Std pkg 10 A

8 x 5 x 15 mm
 12/24 V.



PX60 2 Std pkg 10 A

Replacing 16.770.206
 4.6 x 6.35 x 15.4 mm
 12 V.

Special Bearings



141093

Replacing 16.906.345
Servicing 11.201.440, -534, -598, -666, -667, -670, -675, -727, -754, -758, -769, AAK 5102, -5108, -5112, -5114, -5115, -5117, -5118, -5123, -5131, -5132, -5136
 Bearing kit

Also see Pulley Chapter
and O-ring Survey

Replacing ISKRA

Fan & Pulleys



133874

Replacing 15.905.156
Servicing AAG
O.D. 127 mm, Bore 17 mm



231111

Replacing 16.906.346
Servicing 11.201.440, AAK 5102
O.D. 54.8 mm, Bore 17 mm, W. 32.4 mm,
6 grooves



233618

Replacing 16.906.351
Servicing 11.201.498, IA 0498
O.D. 70. mm, Bore 17 mm, W. 12.8 mm,
Single

Sundry Parts



231484

Servicing 11.201.440, AAK 5102,
IA 0440
22 x 31 x 3.8 mm
Rubber seal S.R.E.



233712 Std pkg 10

Servicing 11.201.440, -498, -675,
11.203.016, AAK 5102, -5105, -5118,
-5315
34.65 x 1.75 mm
O-ring

Replacing LADA

Rotors



133189

Replacing 2108-3701200
Servicing 2108-3701010
 12 V. 55 Amp.
 L. 149 mm, O.D. 88.8 mm, Shaft 15 mm



133191

Replacing 2101-3701200, 2105-3701200
Servicing 2101-3701005, 2105-3701010
 12 V. 42 Amp.
 L. 150 mm, O.D. 87 mm, Shaft 15 mm

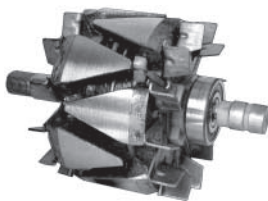

139675

Replacing 0094-3701200
Servicing 2112-3701010, 9402.3701
 12 V. 80 Amp.
 L. 149 mm, O.D. 95 mm, Shaft 15 mm

Stators



130363

Replacing 2101-3701100
Servicing 2101-3701000
 12 V. 42 Amp.
 O.D. 124.1 mm, I.D. 86.1 mm, W. 24.2 mm

Brackets D.E.



134119

Replacing 2101-3701400
Servicing 2101-3701000
Bearing: Cargo 140091



139678

Replacing 0094-3701400
Servicing 2112-3701010, 9402.3701
 W/ bearing



234184

Servicing 21214-3701010, 9412.3701000
Bearing: Cargo 140091

Replacing LADA

Brackets S.R.E.



134120

Replacing 2101-3701300
 Servicing 2101-3701000

Bracket Parts



132572 A

Mounting bushing kit for M12 bolt,
 L. 29 mm

Covers



234763

Replacing 0094.3701640
 Servicing 2124-3701010, 9402.3701,
 9412.3701



139681 Std pkg 5 **A**

Replacing 0094.3701302
 Servicing 2112-3701010, 9402.3701
 O.D. 37.5 mm, I.D. 30 mm, L. 13.4 mm
 Bearing cap



234147

Servicing 2121-43701010
 Bearing cap
 O.D. 40 mm, L. 41.9 mm

Replacing LADA

Regulators



130613

Replacing 2101-3702000
Servicing Lada 1200
 12 V.
 Electronic



130651

Replacing 2900-52-1
Servicing Lada 1300
 12 V.
 Electronic



131046

Replacing 2105-3701500
Servicing Lada 1500
 12 V.
 Electronic



131209

Replacing 2108-3701500
Servicing Lada Samara
 12 V.
 Electronic



Rectifiers



133397 HD

Replacing 2108-3701315
Servicing Lada Samara
 W/ diode trio



235171

Replacing BB01-105 
Servicing 2110-3701010, 2112-3701010,
 21214-3701010



Replacing LADA

Slip Rings



133349 Std pkg 5
O.D. 32 mm, Shaft 15.5 mm, L 22.5 mm



133401 Std pkg 10 **A**
O.D. 32 mm, Shaft 17 mm, L 22.5 mm
W/ 1.8 mm copper

Brush Boxes



130703 **A**
Replacing 2101-3701470
Servicing 2101-3701000
12 V. Complete w/ brushes



131554 **A**
Replacing 2900 52 04
Servicing Lada 1300
12 V. Complete w/ brushes



134784
Replacing 2108-3701550
Servicing 2108-3701010
12 V. Complete w/ brushes

Brush Sets



JX30-31 2 Std pkg 10 **A**
8 x 5 x 16/14.5 mm
12 V.

Replacing LADA

Also see Pulley Survey
page 809

Fan & Pulleys

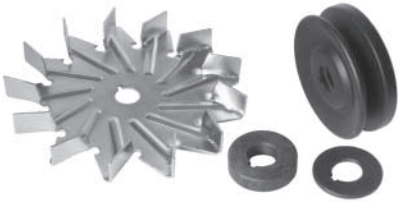

132592

Fan: O.D. 137 mm
Pulley: O.D. 72.7 mm, Bore 15 mm,
W. 20.6 mm
Fan and single pulley

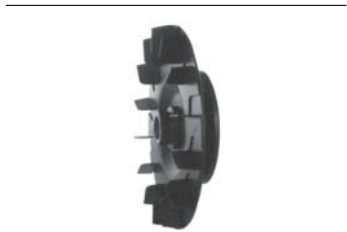

134943

Replacing 2101-3701051
Servicing 2101-..., 2105-..., 2108-...
Fan: O.D. 140 mm
Pulley: O.D. 79 mm, Bore 15 mm
Fan and single pulley

Sundry Parts



132323 Std pkg 10 **A**
Connection



134727 Std pkg 10 **A**
5 x 21.5 mm
Rivet

235155 
Servicing 2110-3701010, 2112-3701010,
21214-3701010
16.95 x 6.3/6.3 x 7.89
Insulator

Replacing LEECE NEVILLE

Rotors

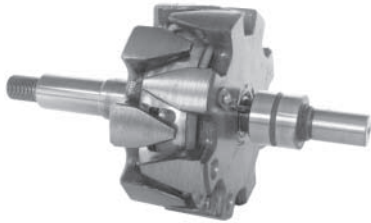

232815

Replacing 98040
 12 V. 65/100 Amp.
 L. 220 mm, O.D. 116.5 mm, Shaft 22.23 mm
 Seal: Cargo 232743



233221

Replacing 79011, 100199
Servicing 2500JB, 2600JB
 12 V. 90/105 Amp.
 L. 238.4 mm, O.D. 121 mm, Shaft 22.23 mm



233222

Replacing 79192
Servicing 2700JB, 2800JB
 12 V. 130/160 Amp.
 L. 235.3 mm, O.D. 121 mm, Shaft 22.23 mm



233223

Replacing 95022
Servicing 7700JA series
 12 V. 165 Amp.
 L. 183 mm, O.D. 121 mm, Shaft 17 mm

Rotor Parts



232743

Std pkg 5
 17.5 x 23.1 x 4.6 mm
 (0.69" x 0.91" x 0.18")
 Used on rotor w/ 0.688" shaft
 Seal

Replacing LEECE NEVILLE

Stators



130528

Replacing 98818
 12 V. 85 Amp.
 24 V. 65 Amp.
 O.D. 158.2 mm, I.D. 116 mm, W. 25.3 mm



230589

Replacing 97078
Servicing 2800J, 5522AA, 7606A,
 7706AA, 7706J, 7706JA
 12 V. 160 Amp.
 O.D. 168.5 mm, I.D. 121.7 mm, W. 28.6 mm

Brackets D.E.

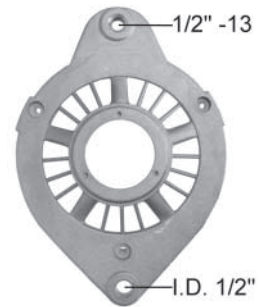

232383

Replacing 78983
Servicing 2300J, 2301J, 2303J, 2304J,
 2360J, 2500J, 2509J, 2511J, 2600J,
 2670J, 2700J, 2800J, 2805J, 4425J,
 4426J, 4625J, 4626J, 4632J, 4725A
 Bearing: Cargo 140883



230587

Replacing 77339
Servicing 2300J, 2600J, 7600AA, -JA,
 7601AA, -JA, 7602AA, -JA, 7603AA,
 7604AA, -JA, 7605AA, -7606AA, -7609AA
 12 V. 105 Amp.
 O.D. 168.35 mm, I.D. 121 mm, W. 29 mm



233217

Replacing 77773
Servicing 5522AA, 5523AA, 5528A,
 7606A, -JA, 7705JA, 7706A, -JA, RJ7706
 Bearing: Cargo 140278



230588

Replacing 77792
Servicing 2670J, 2700J, 7700JA,
 7702JA, 7704JA, 7705JA, 7709JA
 12 V. 130 Amp.
 O.D. 168.1 mm, I.D. 121.7 mm, W. 28.2 mm

Replacing LEECE NEVILLE

Brackets S.R.E.



232384

Replacing 71182, 79018, 79022, 79312
Servicing 2300J, 2301J, 2303J, 2304J, 2360J, 2500J, 2509J, 2511J, 2600J, 2670J, 2700J
 Needle bearing: Cargo 140241



233218

Replacing 71098
Servicing 5522AA, 5523AA, 5528AA, 7600A, -JA, 7601A, -AA, -JA, 7602A, -JA, 7603A, 7604A, -JA, 7605A, -JA, 7606A, -JA, 7607JA, 7700JA, 7702JA, 7704JA
 Bearing: Cargo 140087

Bracket Parts



233276

Replacing 77916
Servicing 2300-2800 JB
 12.7 x 19.05 x 20.64 mm
 (1/2" x 3/4" x 11/16")
 Mounting bushing, S.R.E.



233277

Replacing 73651
Servicing 7000-7700
 11.11 x 15.88-23.81 x 17.46 mm
 (7/16" x 5/8"-15/16" x 11/16")
 Mounting bushing, S.R.E.

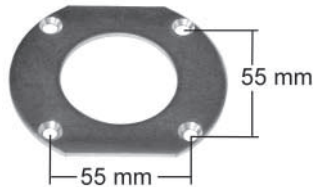

232770

Replacing 59234
Servicing 2300-2800J series, 4400-4700J series, 7000-7700 series
 I.D. 44.5 mm
 Bearing retainer, D.E. bracket



233278

Replacing 78990
Servicing 2300-2800JB
 Dust cap for S.R.E. bearing

Regulators

Adjustable voltage



137227

Replacing 79350
Servicing JB - Series Alternators, 2304J, 2511J
 24 V.

Adjustable voltage



138247 HD

Replacing 5042R
 24 V.
 Pos. - Neg. - Field
 Max. Field current 6 Amp.

Adjustable voltage



230591 HD

Replacing 79000
Servicing 2300J, 2360J, 2400J, 2500J, 2600J, 2670J, 2700J, 4800JB, 4805JB, 4824JB, 4829JB
 12 V.
 Diode trio activated

Replacing LEECE NEVILLE

Adjustable voltage



230605

Replacing 77973
Servicing 4425JA, 4450JA, 4625JA, 4650JA, 4725JA, 4750JA, 7500J, 7501J, 7502J, 7504J, 7506J, 7513J, 7600JA
 12 V.

Rectifiers



137228

Replacing 71180, 78752
Servicing JA - Series Alternators, JB - Series Alternators
 Positive
 Super Cool w/ 50 Amp. diodes for 105/165 Amp. alternators.



230607

Replacing 79415
Servicing 2670J, -JC, 2700J, -JC, 4700A, 4725JA, 4750JA, 7700AA, -JA, 7701AA, 7702AA, -JA, 7703AA, 7704JA
 Negative
 3-70 Amp. Press fit diodes

Adjustable voltage



233231

Replacing 5078R
 12 V.
 Positive, negative field



137229

Replacing 71181, 78753
Servicing JA - Series Alternators, JB - Series Alternators
 Negative
 Super Cool w/ 50 Amp. diodes for 105/165 Amp. alternators.



230752

Replacing 97084
Servicing 2706JB, 2800J, -JC, 2802J, -JC, 2803J, 2805J, -JC, 2808JB, 2810JB, 2812JB, 2813JC, 2819JB, 2913JC, 4727JB, 4728JB, 4800JB
 Positive

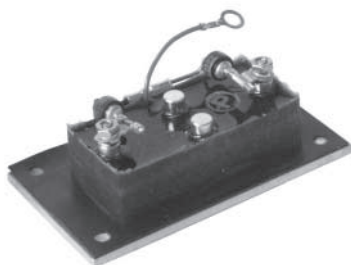

233696

Replacing 96852
Servicing 4727JB, 4728JB, 4826JB
 24 V.
 Diode trio activated

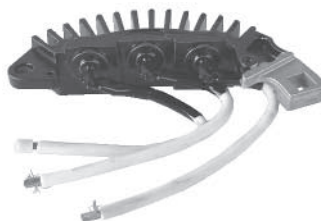

230606

Replacing 79193
Servicing 2670J, -JC, 2700J, -JC, 4700A, 4725JA, 4750JA, 7700AA, -JA, 7701AA, 7702AA, -JA, 7703AA, 7704JA
 Positive
 3-70 Amp. Press fit diodes



230753

Replacing 97085
Servicing 2706JB, 2800J, -JC, 2802J, -JC, 2803J, 2805J, -JC, 2808JB, 2810JB, 2812JB, 2813JC, 2819JB, 2913JC, 4727JB, 4728JB, 4800JB
 Negative

Replacing LEECE NEVILLE

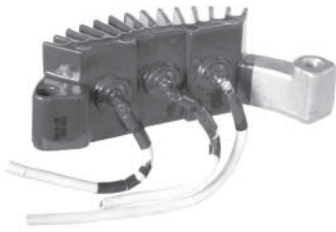

232444

Replacing 101387, A051101387
Servicing 4860J, -JB, 4884J, -JB, 4900J, -JB
 Positive
 W/ 50 Amp. diodes

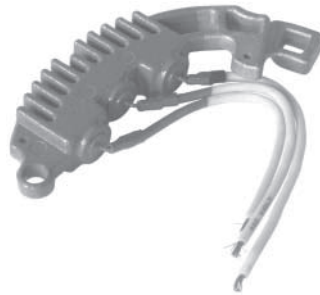

233226

Replacing 71190, 71237, 78752
Servicing 2301J, 2302J, 2303J, 2304J, 2509J
 65 Amp. alternators
 Positive

Diode Trios

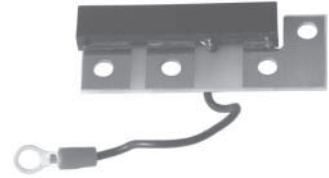

233228

Replacing 79027
Servicing 2300-2800JB series



232445

Replacing 101411, A051101411
Servicing 4860J, -JB, 4884J, -JB, 4900J, -JB
 Positive
 W/ 50 Amp. diodes

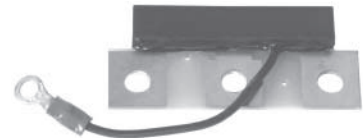

233229

Replacing 79480
Servicing 3425J-3725J series

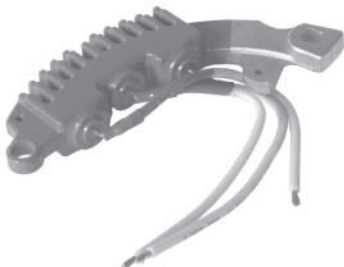

233225

Replacing 71191, 78517, 78753
Servicing 2301J, 2302J, 2303J, 2304J, 2509J
 65 Amp. alternators
 Negative



233230

Replacing 79026
Servicing 4400-4700J series

Replacing LEECE NEVILLE



234499

Replacing 96603
Servicing 4728JB, 4826JB, 4727JB, 4827JB

Slip Rings



133920 Std pkg 10

Replacing 71189
Servicing 2300-2800 JB series
 O.D. 29.3 mm, Shaft 17 mm, L. 41.1 mm



233224

Replacing 57462
 O.D. 23.4 mm, Shaft 11.8 mm,
 L. 27.7 mm

Brush Sets



140881

Replacing 77650
 12/32 V.
 7.5 x 22 mm, LL. 46 mm



141177

Replacing 71128
Servicing 4400A series
 12/24 V.
 7.5 x 12.5 mm, LL. 44 mm



141178

Replacing 97893
Servicing 3425-3725J, 4400-4700J,
 4425-4750J, 7500-7700J, -JA
 12/32 V.
 7.5 x 12.5 mm, LL. 41 mm

Also see Bearing Chapter
page 821

Replacing LEECE NEVILLE

Special Bearings



140882

Replacing 32054, 36686, 4090
25/52 x 20.6 mm
S.R.E.



140883

Replacing 35624
25/62 x 25.4 mm
D.E.



140884

Replacing 29662, 74091
30/72 x 30.2 mm
D.E.

Needle Bearings



140241 Std pkg 10

Replacing 78625
Servicing 2300, 2800JB series
17/23.8 x 20.6 mm
Closed end

Roller Bearings



141087

Replacing 79406
Servicing 3425J, 4425J
22/40 x 11.9 mm
Used w/ Inner race: Cargo 141089



141089

Replacing 79424
Servicing 3425J, 4425J
17/22.1 x 36.5 mm
Inner race
Used w/ Roller bearing: Cargo 141087

Replacing LEECE NEVILLE

Also see Pulley Survey
page 809

Fan & Pulleys



233219

Replacing 79035
Servicing 2300-2800JB, 4425-4750J
O.D. 178 mm, Bore 22.23 mm (7/8")
Fan



131176

Replacing 73981, 76699
Servicing 2300, 2800JB series
O.D. 78.8 mm, Bore 22.23 mm (7/8"),
W. 39.8 mm
Double, B-type belt



232145

Servicing 2300-2800J series
O.D. 108.4 mm, Bore 22.23 mm (7/8"),
W. 40.8 mm
Double, B-type belt



232146

Servicing 2300-2800J series
O.D. 108.1 mm, Bore 22.23 mm (7/8"),
W. 56.7 mm
Tripple, B-type belt



232147

Replacing 74281, K176074281
Servicing 2300-2800JB series
O.D. 82.7 mm, Bore 22.23 mm (7/8"),
W. 34.9 mm
Double, B-type belt

Fan & Pulley Parts



232645

Replacing 59225
Servicing 4400-4750J series,
7000-7700J series
22.23 (7/8") x 34.7 x 5 mm
Spacer

Replacing LEECE NEVILLE

Sundry Parts



233255
Replacing 79030
Servicing 2300-2700JB
 Brush holder
Brush set: Cargo 140881
Gasket: Cargo 233257



233259 Std pkg 5
Replacing 73546
Servicing 2300-2800J, 7000-7700J
 I.D. 8.5 mm (5/16")
 Positive terminal
 Insulator



233264
Replacing 96545
Servicing 2300-2800JB
 0.5 mf.
 Condenser



233256
Replacing 58777
Servicing 2200A, 4400-4700A,
 7000-7700A
 Brush holder
Brush set: Cargo 141177, 141178



233260 Std pkg 5
Replacing 73547
Servicing 2300-2800JB, 7000-7700
 I.D. 5 mm
 Insulator for rectifier



233265
Replacing 79036
Servicing 2300-2700JB
 Dim.: 10-32
 Terminal for relay



233257
Replacing 79031
Servicing 79030, Cargo 233255
 Gasket



233261 Std pkg 5
Replacing 79070
Servicing 2300-2800JB
 I.D. 6.5 mm x L. 19 mm, (1/4" x 3/4")
 Negative terminal
 Insulator



233266
Replacing 71197
Servicing 2300-2700JB
 1/4"-20 x L. 2 1/2"
 Negative post
 Terminal



233258 Std pkg 5
Replacing 73545
Servicing 2300-2800J, 7000-7700J
 I.D. 6.5 (1/4")
 Negative terminal
 Insulator



233263 Std pkg 5
Replacing 79071, 96851
Servicing 2300-2800JB
 I.D. 8 mm x L. 19 mm, (5/16" x 3/4")
 Positive terminal
 Insulator



233267
Replacing 78997
Servicing 2300-2700JB
 5/16"-18 x L. 2 1/2"
 Positive post
 Terminal

Replacing LEECE NEVILLE



233268

Replacing 58432
 Servicing 7000-7700
 1/4"-20 x L. 1 3/4"
 Negative post
 Terminal



136409 Std pkg 3

Replacing 73657
 Servicing 4400-4700
 Connector for terminal plate



233269

Replacing 58431, 778336
 Servicing 7000-7700
 5/16"-18 x L. 1 3/4"
 Positive post
 Terminal



233272

Replacing 78705
 Servicing 4400-4700J
 Connector for negative terminal



233270

Replacing 97086
 Servicing 2800JB
 5/16"-18 x L. 3 7/16"
 Positive/negative post
 Terminal



233273

Replacing 78706
 Servicing 4400-4700J
 Connector for positive terminal



233271

Replacing 76635
 Servicing 4400-4700
 Terminal plate



233275

Replacing 79377
 Servicing 2300-2800J
 Connector, negative terminal to ground

Replacing LUCAS

Rotors



131629

Replacing 54203288, UDB109
Servicing A115: 23983, 23984, 23985, 23986, 24023, 24024, 24026, 24027
 12 V. 36/45 Amp.
 L. 159 mm, O.D. 83.5 mm, Shaft 15 mm
Nut: Cargo 130910



136128

Replacing 54200042, -067, UDB100
Servicing 17ACR, 18ACR
 12 V. 38/43 Amp.
 L. 150 mm, O.D. 83 mm, Shaft 15 mm
Nut: Cargo 130910



139465

Replacing 54206538, UEB101
Servicing A127: 24161, 24202, 24206, 24207, 24209, 24216, 24217, 24220
 12 V. 65/70 Amp.
 L. 143.9 mm, O.D. 89.5 mm, Shaft 17 mm
Nut: Cargo 135049



131630

Replacing UEB100
Servicing A127: 24145, 24156, 24157, 24158, 24200, 24208, 24214, 24215
 12 V. 55 Amp.
 L. 143 mm, O.D. 89 mm, Shaft 17 mm
Shaft: Cargo 138122, Nut: Cargo 135049



136982

Replacing 54208671
Servicing 24406, 54022415, 54022578, 54022711
 24 V. 30 Amp.
 L. 144 mm, O.D. 90 mm, Shaft 17 mm
Nut: Cargo 135049

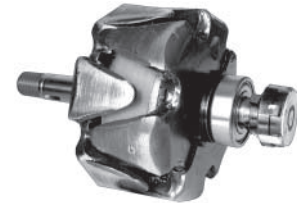

139880

Replacing 54202267, -268, UFB104, -105
Servicing 23ACR, 25ACR
 12 V. 55/65 Amp.
 L. 156.3 mm, O.D. 97.2 mm, Shaft 15 mm
Nut: Cargo 130910

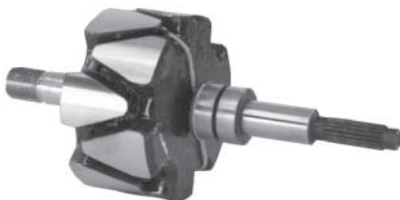

133845

Replacing 54206600, UEB104
Servicing A127: 24188, 24316
 12 V. 55 Amp.
 L. 202 mm, O.D. 89 mm, Shaft 17 mm, 18 splines
Shaft: Cargo 135244, Nut: Cargo 135049



137118

Replacing UFB109, -112
Servicing A133: 23998, 23999, 24010, 24011, 24040, 24069, 24070, 24091, 24093, 24100, 24125, 24126, 26127
 12 V. 65/75 Amp.
 L. 159 mm, O.D. 97 mm, Shaft 15 mm
Nut: Cargo 130910



231066

Replacing 54201945, 54218284, UDB101
Servicing 15ACR, 16ACR
 12 V. 28/34 Amp.
 L. 144.5 mm, O.D. 83.4 mm, Shaft 15 mm

Replacing LUCAS



234852

Replacing 54206860, 54209332

Servicing A127: 24230, -264, -293, -374, 12 V. 70 Amp.

L. 202 mm, O.D. 89 mm, Shaft 17 mm, 16 Splines

Shaft: Cargo 135244, Nut: Cargo 135049



Rotor Parts



130910 Std pkg 10 **A**

Servicing 15,16,17,18ACR, A115, A133
Rotor shaft nut



135244

Servicing A127, UEB104, 54206860, Cargo 133845, 234852

L. 202 mm, Shaft 17 mm, 18 splines
Rotor shaft



135049 Std pkg 10 **A**

Replacing 54134696

Servicing A127

Rotor shaft nut



138122

Servicing UEB100, Cargo 131630

L. 143 mm, Shaft 17 mm

Rotor shaft



134101 Std pkg 10 **A**

Servicing A115, A133

Rotor wire separator

Th. 8 mm, 15 mm bore



130813 Std pkg 10 **A**

3 x 5 x 13 mm

Key



134102 Std pkg 10 **A**

Servicing ACR

Rotor wire separator

Th. 10 mm, 15 mm bore

Replacing LUCAS

Stators

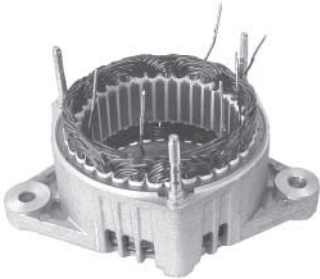

230143

Replacing 54209326
Servicing A127i: 54022464
 12 V. 100 Amp.
 Stator w/ Bracket D.E.
Stator only: Cargo 137224



133693

Replacing UJB104, -108
Servicing A133: 23996A, 23997A, 24038A, 24046A, 24047A, 24067A, 24068A, 24086A, 24088A, 24089A, 24096A, 24098A
 12 V. 45/55 Amp.
 O.D. 133.7 mm, I.D. 97.6 mm, W. 25.5 mm



133830

Replacing UHB104, -106
Servicing A115-34: 23986A, 24023A, 24026A, 24027A, 24036A, 24061A, 24062A, 24063A, 24092A, 24095A
 12 V. 34 Amp.
 O.D. 113.6 mm, I.D. 83.1 mm, W. 19 mm



133192

Replacing 54205305, UIB100
Servicing A127-55
 12 V. 55 Amp.
 O.D. 127.5 mm, I.D. 89.5 mm, W. 25 mm



133694

Replacing UIB101, 54205306
Servicing A127: 24158A, 24161A, 24230, 24264
 12 V. 65/75 Amp.
 O.D. 126.9 mm, I.D. 89.3 mm, W. 26.5 mm



133971

Replacing 54203342, UHB103, -107
Servicing A115/45, 18ACR: 23980A,B, 24139A
 12 V. 43 Amp.
 O.D. 113.8 mm, I.D. 82.7 mm, W. 25 mm



133681

Replacing UJB106, -107
Servicing A133: 23970A/B, 23971A, 23998A, 23999A, 24010A, 24011A, 24049A, 24069A, 24070A, 24090A, 24091A, 24093A
 12 V. 65/75 Amp.
 O.D. 133.6 mm, I.D. 96.4 mm, W. 25.6 mm



133829

Replacing UHB108, -109
Servicing 16, 17 ACR
 12 V. 36 Amp.
 O.D. 113 mm, I.D. 83.9 mm, W. 24 mm



138803

Replacing 54208681
Servicing A127: 54022415, -578, 633 242 99, 633 244 06
 24 V. 30 Amp.
 O.D. 126.6 mm, I.D. 90.1 mm, W. 25.1 mm

Replacing LUCAS



230271

Replacing 662 013 02, 662 017 84
Servicing 660 210 70, 660 211 21, -36, -37, -47, -48, -49, -50, -51, -52, -60
 12 V. 70 Amp.
 O.D. 127.1 mm, I.D. 88.8 mm, W. 16.2 mm



235148

Replacing 54218277, UHB110
Servicing 15ACR
 12 V. 28 Amp.
 O.D. 115 mm, I.D. 83.9 mm, W. 20 mm



Brackets D.E.



130857

Replacing 54200544
Servicing ACR
 Right hand mounting
Bearing: Cargo 140091, 6302
Fitting kit: Cargo 134039



130859

Replacing 54219275
Servicing ACR
 Left hand mounting
Bearing: Cargo 140091, 6302
Fitting kit: Cargo 134039



134033

Servicing A133
 Right and left hand mounting
 w/o thread
Bearing: Cargo 140091, 6302



134036

Servicing A127
 Right and left hand mounting
 W/o thread
Bearing: Cargo 140087, 6203



135181

Replacing 54203147
Servicing A133
 Left hand mounting
Bearing: Cargo 140091, 6302



135182

Replacing 54202918
Servicing A133
 Right hand mounting
Bearing: Cargo 140091, 6302

Replacing LUCAS

Brackets S.R.E.



135183

Replacing 54205169
Servicing A127
 Left hand mounting
Bearing: Cargo 140087, 6203



139321

Replacing 54207042
Servicing 54022536



130858

Replacing 54200781
Servicing ACR
Bearing: Cargo 140084, 6202



135184

Replacing 54205168
Servicing A127
 Right hand mounting
Bearing: Cargo 140087, 6203



231496

Replacing 54201972
Servicing 15, 16 ARC, A115: 23865, 23880, 24022, 24060, 24087, 24123
 W/ bearing



134037

Replacing 54206507
Servicing A127: 24136, 24145, 24156, 24157, 24169, 24200, 24208, 24209, 24217, 24240, 24260
Needle bearing: Cargo 140120



137794

Replacing 54208079
Servicing A127: 54022375, -608, 24286
Bearing: Cargo 140087



134043

Replacing 54203198, 54203199
Servicing A133: 23969, 23970, 23971, 23996, 23997, 23998, 23999, 24010, 24011, 24020, 24025, 24034, 24038, 24046, 24047, 24049, 24067, 24068, 24069, 24070, 24090, 24091, 24093, 24100, 24101, 24102, 24110
Bearing: Cargo 140084, 6202

Replacing LUCAS

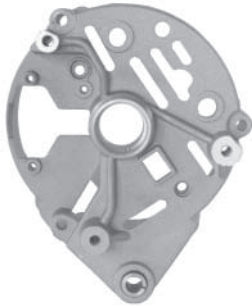

134667

Replacing 54206470
Servicing A127: 24188, 24230, 24264
 Ford Transit Diesel w/ vacuum pump
 Needle bearing: Cargo 140240



231342

Servicing A127: 54022459
 Bearing: Cargo 140273



231543

Servicing 54022453B



137188

Replacing 54208098
Servicing A127: 24286, 54022375, -608
 Needle bearing: Cargo 140240



231497

Replacing 54203700
Servicing A115: 24041, 24085, 24087, 24147, 24171, 60921062
 W/ O-ring



233126

Replacing 836 183 31
Servicing A127IR: 54022549, 633 203 34, -35, -36, -38, -39, -48, -49, 633 213 24, -43, -44, -45, -46, -47, 633 214 22, -61, -62, -66, -73
 Bearing: Cargo 141071

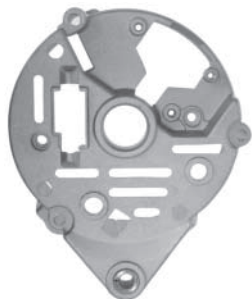

137725

Replacing 54206019, 54206024
Servicing A127-55A: 24235, 24238, 24271, 54022303, -305, -307, -400, -446, -447, -450, -559, -597, -631



231498

Replacing 54203702
Servicing A115: 23983, 23985, 23986, 24023, 24024, 24027, 24028, 24035, 24036, 24037, 24051, 24061, 24062, 24065, 24066, 24071, 24072, 24079
 W/ O-ring



234176

Servicing A127: 54022464
 Bearing: Cargo 140273

Replacing LUCAS

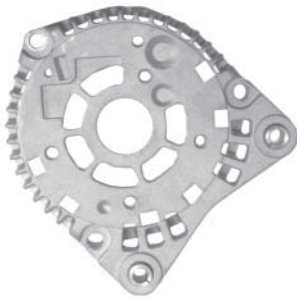

234416

Servicing A127i: 54022468
Bearing: Cargo 140273

Bracket Parts



134038 A

Servicing ACR
 Fitting kit
Bearing: Cargo 140084, 6202



136461 Std pkg 5

Replacing 54207056
Servicing A127
 8 x 13.5 x 20 mm
 Mounting bushing, S.R.E.



134039 A

Servicing ACR
 Cargo 130857, 130859
 Fitting kit
Bearing: Cargo 140091, 6302



230220 Std pkg 10

8 x 13.05 x 11 mm
 Mounting bushing



134774 Std pkg 10 A

Servicing 15ACR, 16ACR, 17ACR,
 18ACR
 8 x 13.05 x 20 mm
 Mounting bushing, D.E.



232063 Std pkg 5

Servicing A115i
 8.8 x 15/21.2 x 25 mm
 Mounting bushing, S.R.E.

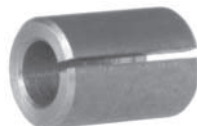

134775 Std pkg 10 A

8 x 14 x 20 mm
 Mounting bushing, D.E.
 Oversize



139952 Std pkg 25 A

Servicing A115 i
 O.D. 37 mm, I.D. 35 mm, W. 14 mm
 Bearing cap

Replacing LUCAS

Covers

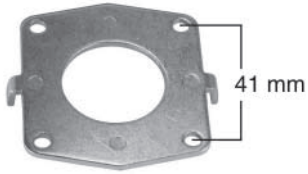

232059 Std pkg 5
 Servicing A115i
 I.D. 28 mm
 Bearing plate

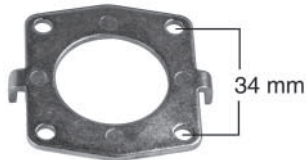

232060 Std pkg 5
 Servicing A115i
 I.D. 28 mm
 Bearing plate



234942 
 Servicing 23967, 24041, 24049, 24102,
 24142, 24150, 24201
 O.D. 57.17 mm
 Bearing plate



232061 Std pkg 5
 Servicing A115i
 Spring clip for S.R.E. Bracket



130895
 Replacing 54219322
 Servicing ACR



131440
 Replacing 54204981
 Servicing A133



131441
 Replacing 54204143
 Servicing A115



132445
 Replacing 54203307
 Servicing A115: 24041, 24060, 24167,
 24168, 24171



132996
 Replacing 54203554
 Servicing A133: 24101, 24102, 24150,
 24173, 24176



134808
 Replacing 54207080
 Servicing A127: 24257

Replacing LUCAS



136114

Replacing 54203006
Servicing 22ACR, 23ACR, 25ACR:
 23833, 23861, 23862, 23863, 23867,
 23882, 23883, 23884, 23885, 23886,
 23894, 23895, 23898, 23907, 23908,
 23930, 23931, 23932, 23933, 23937



138852

Servicing A127i: 24329, 24330
 54022453, -454



139531

Servicing 54022459, -498



137283

Replacing 54209019
Servicing A127



138892

Replacing 54204182
Servicing A133: 24020, 24025, 24034,
 24038, 24067, 24068, 24069, 24070,
 24086, 24088, 24090, 24151, 24153,
 24164, 24166

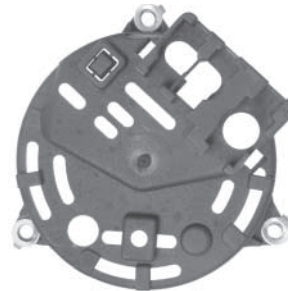

139855

Servicing 54022443, 54022549



137615 Std pkg 5

Replacing 54205012, 60211167
Servicing A133: 24091, 24093, 24100,
 24125, 24127, 24152, 24154, 24155



138921

Replacing 54206277
Servicing A127: 24214, 54022171



231850

Replacing 54201744
Servicing 23967

Replacing LUCAS

Regulators



233882

Replacing 54208561
Servicing A127: 24273, 24274, 54022336, -337



130637

Replacing 37566, UCB100
Servicing ACR 12 V.



130642

Replacing 37628, UCB109
Servicing ACR 12 V.



234488

Replacing 54207605
Servicing A127: 24271, 24288, 54022307, -597



130639

Replacing 37596, UCB104
Servicing ACR 12 V.



131145

Replacing 37667, UCB129
Servicing A115, A133 12 V.



130641

Replacing 37602, UCB107
Servicing ACR 12 V.



131277

Replacing 28000, 54206688, UCB150
Servicing A127: 24145, 24156, 24157, 24158, 24161, 24169, 24198, 24199, 24200, 24206, 24207, 24208, 24223 12 V.
Brush set: Cargo 140613

Replacing LUCAS



132105

Replacing UCB128

Servicing A133: 23999, 24010, 24011, 24027, 24028, 24035, 24055, 24079, 24183, 24184, 25998
12 V.

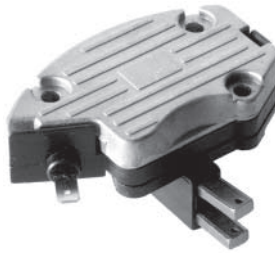

135231

Replacing 28002, UCB155

Servicing A127: 24299, 24406, NAB901, -903, 54022415
24 V.



Volt setting 14.8 V.

230283

Servicing A127



132106

Replacing UCB130

Servicing A115: 24071, 24072, 24191, 24210, 24211
12 V.



136457

Replacing 24TR, 54209735, UCB 812

Servicing A127i: 24329, 24330, 54022453, -454, -459, -487, -521, -527
12 V.

W/o terminal S

Brush set: Cargo 140895



232636

Servicing A127: 54022667, -670
24 V.



133789

Replacing 28006, 37735, UCB153

Servicing A127: 24246, 24256, 24273, 24274
12 V.

Brush set: Cargo 140613

Insulator: Cargo 134955

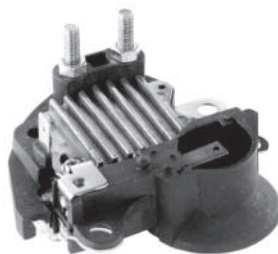

139651

Replacing 28015A, 54209276

Servicing 54022443
12 V.

W/ battery sensor

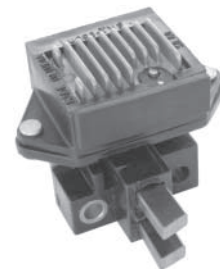

234744 OE

Replacing 26938161A, -181A

Servicing 26021117
12 V.



Replacing LUCAS

Rectifiers

235391

Replacing 35382015

Servicing Cargo: 112278, -279, -280, -283, -284, -285
12 V.

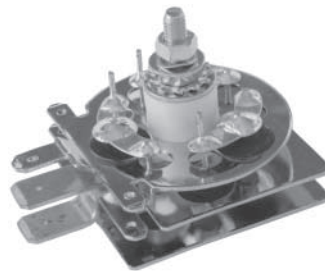

130643 HD

Replacing 83166, UBB110

Servicing ACR
3 terminals, copper plated
Steel heat sink



130646

Replacing 83422, UBB113

Servicing 23, 25 ACR

Regulator Parts



139632 Std pkg 10

Servicing A127

8-36 x 29.5 mm

Regulator bolt



130644

Replacing 83192, UBB108

Servicing ACR

2 terminals

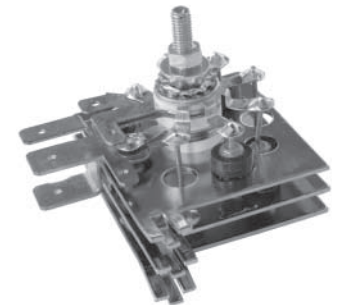

130647

Replacing 83452, UBB130

Servicing 22, 23, 25 ACR

55 Amp.

W/ European terminations

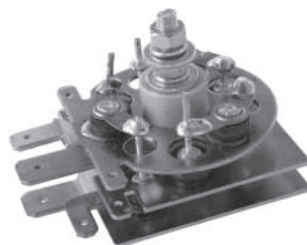

130645

Replacing 83295, UBB111

Servicing ACR

3 pin sensing



131303 HD

Replacing 83565, 83670, UBB117, -120

Servicing A115, A133: 24041, 24060,

24167, 24168, 24171

B+ terminal M6 x 16 mm

Replacing LUCAS



131304 HD

Replacing 84454, UBB135
Servicing A127: 24145, 24156, 24157, 24158, 24161, 24169, 24198, 24199, 24200, 24208, 24209



132720

Replacing 84468, UBB136
Servicing A127: 24203, 24214, 54 022 128



133430 HD

Replacing 84888, UBB147
Servicing A127: 24255, 24287
 B+ terminal M6 x 46 mm



131689

Replacing 83584, UBB128
Servicing 18 ACR: 23980, 23992, 24140



132721 HD

Replacing 84469, UBB137
Servicing A127: 24206, 24207, 24217, 24220, 24221, 54 022 159



133431

Replacing 84113, 84641, UBB139
Servicing A133: 24146, 24194, 24197, 24218, 24222, 24229, 24238, 24239, 24247, 24248, 24251, 24263



132718 HD

Replacing 84456, UBB140
Servicing A127: 24188, 24213, 24230, 24264



133429

Replacing 83548, 83763, UBB131
Servicing A133: 23970, 23971, 24056, 24101, 24102, 24110, 24142, 24150, 24173, 24176, 24186, 24201, 24250, 24275



134845 HD

Replacing 83646, UBB115, -123
Servicing A115: 23983, 23984, 23985, 23986, 24023, 24024, 24038, 24046, 24047, 24048, 24035, 24049, 24051, 24052, 24059, 24061, 24062, 24063, 24064, 24065

Replacing LUCAS



134846

Replacing UBB116, -121
Servicing A133: 23996, 23997, 23998, 23999, 24020, 24025, 24034, 24038, 24049, 24053, 24054, 24058, 24067, 24069, 24070, 24071, 24072, 24079, 24086, 24088, 24089, 24090, 24096



136458

Replacing 836 102 31
Servicing A127
 B+ terminal M8 x 52 mm
 Spacer: Cargo 235288



138808

Replacing 84574, UBB138
Servicing A127: 24223, 24235, 24322, 24332, 24380, 24390, 54022238, -437, -510, -536, -591, -631, -633, -646
 B+ terminal M6 x 28 mm
 D+ terminal M5 x 29 mm



134847

Replacing UBB118
Servicing A133: 23969, 24010, 24011, 24046, 24047, 24055, 24091, 24093, 24100, 24125, 24126, 24127



136666

Replacing 84572, UBB145
Servicing A127: 24215, 24216, 24224, 24236, 24257, 24261, 24271
 w/ W-terminal 46 mm
 B+ terminal M6 x 33 mm
 D+ terminal M4 x 18 mm



231485

Replacing 83643, UBB 122
Servicing 24036, 24037, 24144
 W/ W-terminal



136324 HD

Replacing 84976
Servicing A127: 24286, 54022375, 23100-71J00
 D+ terminal M6 x 28 mm



136740

Servicing 24326, 54022244B, -443, -459, -498
 W/ Diode trio
 B+ terminal M6 x 8 mm
 Gasket: Cargo 230375



231486

Replacing 83839
Servicing 24129, 24154, 24155
 W/ W-terminal

Replacing LUCAS



234745

Replacing 26948040A, 26991540
 Servicing 26021117



Rectifier Parts



134451 Std pkg 10 **A**
 Wire for rectifier



232058 Std pkg 5
 Servicing A115i
 O.D. 13 mm, I.D. 9.3 m, L. 13 mm
 Sleeve for rectifier



139151 Std pkg 5
 Servicing 15/16/17/18 ACR
 Mounting rubber for rectifiers



230375 Std pkg 5
 Servicing A127i
 Gasket for rectifier 105 mm



232057 Std pkg 10
 Servicing A115i
 O.D. 8.9/14.8 mm, I.D. 5.7 m, W. 7 mm
 Insulator for rectifier

Replacing LUCAS

Also see Diode Chapter
page 780

Diodes



131292 Std pkg 10 **A**
Replacing 83577
 25 Amp. 200 V.
 10 mm press fit
 20 mm lead
 Negative



131293 Std pkg 10 **A**
Replacing 83576
 25 Amp. 200 V.
 Positive
 10 mm press fit
 20 mm lead



233356
 35 Amp. 200 V.
 10 mm press fit
 Positive



233357
 35 Amp. 200 V.
 10 mm press fit
 Negative



235276
 50 Amp. 200 V.
 10 mm press fit,
 21 mm lead
 Positive



235277
 50 Amp. 200 V.
 10 mm press fit,
 21 mm lead
 Negative



Slip Rings



131342 Std pkg 10 **A**
Replacing 54217372, UAB104
Servicing ACR
 Slotted type, w/ clip



131817 **A**
Replacing UAB101
Servicing A115, A133
 O.D. 25 mm, Shaft 9 mm



132642 Std pkg 5 **A**
Servicing A127: 24145, 24156, 24157,
 24158, 24161, 24169, 24198, 24199, 24200,
 24203, 24206, 24207, 24208
 O.D. 27 mm, Shaft 17 mm, L. 24 mm



138441 Std pkg 5 **A**
Servicing A115i, A127i
 O.D. 16 mm, Shaft 6.8 mm, L. 46.5 mm

Replacing LUCAS

Brush Boxes



130706

Replacing 54219309, ULB102
 Servicing ACR
 W/o brushes
 Brush set: Cargo LASX 31-32 2



234930

Replacing 54203529
 Servicing A115, A133
 W/o brushes
 Brush set: Cargo 140161 or 140444

Brush Sets



140161 Std pkg 10 **A**

Replacing 60600780, ULB105
 Servicing A115, A133
 4 x 7 x 20 mm
 12 V.



140444 Std pkg 10 **A**

Replacing ULB104, -106, -113
 Servicing A115, A133
 4 x 7 x 20 mm
 12 V.



140613 Std pkg 10 **A**

Servicing A127
 Cargo 131277, 133788, 133789
 4 x 6.9 x 21 mm
 12 V.



140895 Std pkg 10

Servicing A127i
 4.0 x 7.0 x 22 mm
 12 V.



140923

Servicing A127
 4.0 x 7.0 x 22 mm
 12 V.



LAX30 2 Std pkg 10

Replacing 54215076, ULB109
 Servicing 10AC, 11AC
 7.9 x 4.6 x 17.9 mm
 12 V.



LAX31 2 Std pkg 10

Replacing 54218706, ULB108
 Servicing ACR
 4.6 x 4.6 x 12.7 mm
 12 V.



LAX31-32 2 Std pkg 10 **A**

Replacing 54219368, ULB110
 Servicing ACR
 4.6 x 4.6 x 12.7 mm
 12 V.

Replacing LUCAS

Also see Bearing Chapter and Pulley Survey

Needle Bearings



140120 Std pkg 10 **A**
Servicing A127: 24156, 24169, 24200
 17/23.8 x 17.4 mm
 Closed end



140240 Std pkg 10 **A**
Servicing A127 w/ vacuum pump
 17/23.8 x 17.4 mm



141219 **A**
Replacing UMB110
 Harley Davidson
 12.7/17.5 x 14.2 mm
 Closed end

Fan & Pulleys



131028
Replacing 54217652
Servicing ACR
 O.D. 115 mm, Bore 15 mm



132569
Servicing A133
 O.D. 137 mm, Bore 15 mm



234490
Replacing 54205635
Servicing A127
 O.D. 136 mm, Bore 17 mm



131027 Reman.
Servicing ACR
 O.D. 68.6 mm, Bore 15 mm, W. 21.4 mm,
 Single



133584
Replacing 54200002
Servicing ACR, C40
 O.D. 66.7 mm, Bore 15 mm, W. 32.7 mm,
 Double



133692
Servicing A127: 24271
 O.D. 55.5 mm, Bore 17 mm, W. 29.8 mm,
 3 grooves



134518
Servicing A127
 O.D. 66.4 mm, Bore 17 mm, W. 22 mm,
 4 grooves



135058
Servicing 24049
 O.D. 93.5 mm, Bore 15/17 mm, W. 20.4 mm
 Single, B-belt type
 W/ bushing

Also see Pulley Survey
page 809

Replacing LUCAS



135511

Servicing 54022375
O.D. 59.9 mm, Bore 17 mm, W. 18.8 mm,
4 grooves



234777

Servicing A133 
O.D. 83.25 mm, Bore 15 mm, W. 20.3 mm,
Single

Fan & Pulley Parts



133949 Std pkg 10 

O.D. 25.4 mm, Bore 17 mm, Th. 7.0 mm
Spacer



136902

Replacing 54206925
Servicing 54022415
O.D. 61 mm, Bore 18-20 mm cone.,
W. 36.9 mm, 8 grooves
Nut: Cargo 136903



231352 Std pkg 5

Servicing A127
O.D. 27 mm, Bore 17 mm, Th. 5.5 mm
Spacer



232148

Replacing 54214805
Servicing C40T: 22756, 22758
O.D. 87.8 mm, Bore 15 mm, W. 29.8 mm,
Single, B-type belt



234004 Std pkg 5

Replacing 54205630
Servicing A127
O.D. 27 mm, Bore 17 mm, Th. 7.5 mm
Spacer



232342

Servicing 24291, 54022536, 54022639
O.D. 54.4 mm, Bore 17 mm, W. 29.7 mm,
5 grooves



234200 Std pkg 10

Servicing 23565, -569, -570, -584, -593,
-598, -602, -605, -610, -612, -625, -627,
-635, -642, -643, -647, -648, -649, -650,
-651, -658, -660, -664, -674, -679, -695
O.D. 21.4 mm, I.D. 15.1 mm, Th. 9.5 mm
Spacer

Replacing LUCAS

Also see O-ring Survey page 854

Vacuum Pumps



135981

Replacing 61200564, UXB940
Servicing A127: 24188, 24230, 54022301, -373, -394, -425, -429, -495
 Ford

Vacuum Pump Parts



135942

Servicing A127, 24188, 24230
 O.D. 57.25 mm, L. 34.8 mm, 18 splines
 Rotor



234201 Std pkg 10

Servicing 23565, -569, -570, -584, -593, -598, -602, -605, -610, -612, -625, -627, -635, -642, -643, -647, -648, -649, -650, -651, -658, -660, -664, -674, -679, -695
 O.D. 21.12 mm, I.D. 15.1 mm, Th. 7.24 mm
 Spacer



134894 Std pkg 5

Replacing 60600700
Servicing A127, 15ACR, 16ACR, 17ACR
 Steel bushing for pulley
 From 15 to 17 mm shaft



136903

Servicing 54022415
 Rotor shaft nut
 For pulley Cargo 136902

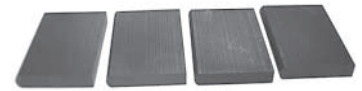

135943

Servicing A127, 24188, 24230
 4.6 x 24.4 x 34.7 mm
 Vane set



136746 Std pkg 5

M14/16-1.5
 Vacuum pump connector



135399 Std pkg 10

Replacing 60601039
Servicing A127 w/ vacuum pump
 32 x 4 mm
 O-ring

Also see O-ring Survey
page 854

Replacing LUCAS



137717 Std pkg 10
Servicing A127
 70 x 2 mm
 O-ring

Repair Kits



135451

Include 130643 Rectifier, 130641 Regulator, LAX31-32 2, 131342 Slip ring, B140084 Bearing, B140091 Bearing
Servicing 15/16/17/18 ACR



139867

Include B131277 Regulator, 131304 Rectifier, 140120 Needle bearing, B140087P Bearing, 136264 Thru bolt kit, 139632 Screw, 132642 Slip ring
Servicing A127



135578

Include 135399 O-ring, 132319 Oil Seal, 140240 Bearing, B140087P Bearing, 131277 Regulator, 134345 Terminal, 135543 Terminal block, 132642 Slip ring
Servicing A127 w/vacuum pump
 12 V.



135586

Include 130643 Rectifier, 130637 Regulator, LAX31-32 2 Brush set, 131342 Slip ring, B140084 Bearing, B140091 Bearing
Servicing 15ACR, -16, -18

Replacing LUCAS

Also see Oil Seal Survey page 856

Sundry Parts



132319 Std pkg 5 **A**
Servicing A127 w/ vacuum pump
 17 x 27 x 7 mm
 Oil seal S.R.E.



134075 Std pkg 5
Replacing 54208202
Servicing A127: 24257, 24271
 Terminal block



134345 Std pkg 10 **A**
Replacing 54192140
Servicing A127: 24188, 24230, 24264
 Terminal for Cargo 134811



134794 Std pkg 10
Servicing 24257, 54022307, -322, -378, 54055205
 Inside M5, Outside M5, L. 27.5 mm
 Adaptor for cover

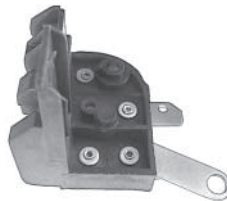

135543
Replacing 54208568
Servicing A127: 54022130, 54022373, 54022394
 Ford
 Terminal block



190733
 Terminal plug
 W/o terminals



132804 **A**
Replacing 54960402
 3-pin plug w/ terminals



234517
Replacing 54208119
Servicing A127: 24295, 24384, 24385, 24414, 24415, 54022526
 Terminal block



190725 Std pkg 100
 Terminal 6.3 mm
 Used w/ terminal plug Cargo 190733



133802 Std pkg 5 **A**
Replacing 54206620
Servicing A127: 24217
 Terminal insulator



134811 Std pkg 5
Replacing 54205820, 60601042
Servicing A127: 24188
 Terminal plug block with leader



190726 Std pkg 50
 Terminal 9.5 mm
 Used w/ terminal plug Cargo 190733

Replacing LUCAS



134955 Std pkg 10
Replacing 54207256
Servicing A127: 24246, 24256, 24273
 NTC connection
 Insulator



136589 Std pkg 5
Replacing 54208043
Servicing A127: 54022375
 B+ insulator



231353
Servicing A127: 54022487
 Resistor



135597 Std pkg 5
Replacing 54208486
Servicing A127: 54022394, -396, -425, -429, -495, -547
 Insulator B+, D+



136590 Std pkg 5
Replacing 54208047
Servicing A127: 24286, 24411, 24418, 54022375
 D+ insulator



139353
Servicing A127: 54022160
 Heat shield



136240
Servicing A127
 B+ insulator kit



138142 Std pkg 10
Servicing A127i
 Square hole
 Insulator for stator leads



232056 Std pkg 5
Servicing A115i
 O.D. 30 mm, I.D. 17 mm, Th. 2.3 mm
 Shaft washer



136329 Std pkg 5
Replacing 54206889
Servicing A127: 24216, 24257, 24771, 54022305, -307, -318, -322, -400, -450, -559
 D+ insulator



233339 Std pkg 10
Servicing A115i, A127i
 Round hole
 Insulator



232062 Std pkg 5
Servicing A115i
 O.D. 13.5 mm, I.D. 9.5 mm, W. 5 mm
 Spacer for B+ stud

Replacing LUCAS



136264
Replacing 60600864
Servicing A127
 M5 x 107 mm
 Thru bolt kit



233860 Std pkg 5
Servicing A127: 54022468, -521
 M4 x 17 mm
 Screw



234007 Std pkg 5
Replacing 54117089
Servicing A127
 M4.4 x 30 mm
 Tapping screw



232055 Std pkg 10
Servicing A115i
 M4 / M5 x 56 mm
 Thru bolt



234670
Servicing A127
 M4 x 20 mm
 Screw



234202
Replacing 54113722
Servicing A127: 23565, -569, -570, -584, -593, -598, -602, -605, -610, -612, -625, -627, -635, -642, -643, -647, -648, -649
 M5 x 85 mm, 32 mm thread
 Thru bolt



234005 Std pkg 5
Replacing 54105279
Servicing A127
 M4.4 x 10.5 mm
 Tapping screw



234422
Servicing A127i: 24329, -344, 54022453, -459, -468, -498, -521, -669
 M6/M7 x 91.5 mm
 Thru bolt



234006 Std pkg 5
Replacing 54117499
Servicing A127
 M4.4 x 35 mm
 Tapping screw

Replacing LUCAS

Generator Armatures



130199

Replacing 54217859, UWB102
Servicing C40A, 22259, 22261, 22276, 22703F, 22733
 12 V. 11 Amp.
 L. 216.3 mm, O.D. 60.6 mm



130824

Replacing 227987, 54217499, UWB100
Servicing C40, 22700, 22715
 12 V. 22 Amp.
 L. 216 mm, O.D. 60.4 mm



130826

Replacing 54218417, UWB106
Servicing C40T, 22754, 22755, 22756, 22757, 22758
 12 V. 11/22 Amp.
 L. 238.2 mm, O.D. 60.5 mm

Generator Armature Parts



130819 Std pkg 10 A
Replacing 198800
Servicing C40
 Rotor shaft nut
 7/16" UNF

Generator Field coils



130189

Replacing 54219374, UWB102
Servicing C40, C40A, C40T, 22718, 22719, 22732, 22735, 22780, 22786
 12 V. 11/22 Amp.

Replacing LUCAS

Generator Brackets C.E.



135792

Replacing 54211125
Servicing C40, 22700, 22704, 22705, 22715, 22721, 22742, 22744, 22747, 22748, 22749, 22767



135793

Replacing 54211099
Servicing C40A, 22703, 22733, 22751, 22780, 22788
 Non ventilated



135794

Replacing 54216363
Servicing C40T, 22756, 22758, 22764
Bearing: Cargo 140106

Generator Brackets D.E.



130873

Replacing 54213670
Servicing C40, 22703, 22733
 Non ventilated
Bearing: Cargo 140084, 6202
Fitting kit: Cargo 134038



130876

Replacing 54216225
Servicing C40T, 22756, 22758, 22764
 Ventilated
Bearing: Cargo 140091, 6302
Fitting kit: Cargo 134039



135795

Replacing 54215165
Servicing C40 R/H, 22700, 22704, 22705, 22715, 22721, 22742, 22744, 22747, 22748, 22749, 22767, 22775
Bearing: Cargo 140084, 6202
Fitting kit: Cargo 134038

Generator Regulators



130033

Replacing 37577, NCB134, RB340
 12 V. 11 Amp.



130038

Replacing 37229, NCB113, RB108
 12 V. 9/12 Amp.



130039

Replacing 37228, NCB112, RB108
 12 V. 9/12 Amp.

Replacing LUCAS

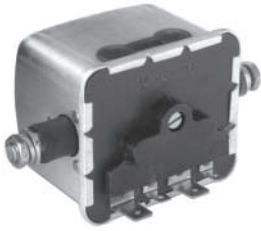

130040

Replacing 37403, NCB119, RB108
12 V. 9/12 Amp.



130041

Replacing 37408, NCB118, RB108
12 V. 9/12 Amp.



130052

Replacing 37290D, E, F, NCB101,
RB106
12 V. 22 Amp.



130883

Replacing 37563A, NCB130, RB340
12 V. 22 Amp.



130884

Replacing 37574A, NCB131, RB340
12 V. 25 Amp.

Generator Brush Sets



LAX9 2 Std pkg 10
Replacing 227305, USB103
6.35 x 19.05 x 15.9 mm
12 V.



LAX23 2 Std pkg 10
Replacing 227541, USB104
5.5 x 19.05 x 18.2 mm
12 V.



LAX29 2 Std pkg 10
Replacing 54216361, USB106
5.5 x 17.4 x 23 mm
12 V.

Replacing LUCAS

Also see Bearing Chapter page 821

Generator Bushings



140062 Std pkg 10
 Replacing 227818, UTB110
 15.1 x 18.2 x 22.2 mm

Generator Bearings



140106 Std pkg 10 A
 Replacing 189307, UTB103, SE5KDD
 Servicing C40T, 22766
 1/2" / 1 1/8" x 5/16"
 C.E.

Generator Sundry Parts



130818 Std pkg 10
 Replacing 54150154
 Servicing C40
 4.7 x 20 mm
 Rivet



130870
 Replacing 54216878
 Servicing C40
 F terminal



132948
 Replacing 54217725
 Servicing C40T
 Tachometer gear

Replacing MAGNETI MARELLI

Rotors



130186

Replacing 4300244, 749 955 71
Servicing 633 031 00, -91
 12 V. 42 Amp.
 L. 147 mm, O.D. 86 mm, Shaft 15 mm



131389

Replacing 749 887 41
Servicing 633 083 00, -10, -20, -30, -40, -50, -60, -70, -80
 24 V. 30 Amp.
 L. 156 mm, O.D. 89 mm, Shaft 17 mm



131643

Replacing 836 000 11
Servicing 633 210 00, -01, -03, -04, -05, -08, -11
 12 V. 55 Amp.
 L. 142 mm, O.D. 89 mm, Shaft 17 mm

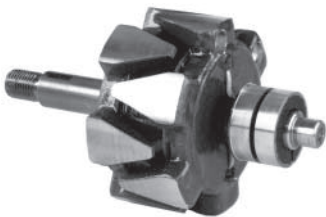

130380

Replacing 4278890, 749 994 21
Servicing 4474902, 633 040 87
 24 V. 26 Amp.
 L. 158 mm, O.D. 86 mm, Shaft 17 mm

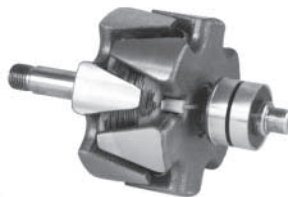

131641

Replacing 9934950, 748 764 01
Servicing AA125
 12 V. 45 Amp.
 L. 156.5 mm, O.D. 88.7 mm, Shaft 15 mm



131943

Replacing 749 879 51
Servicing 633 052 06
 12 V. 45 Amp.
 L. 163 mm, O.D. 89 mm, Shaft 17 mm



130381

Replacing 4278945, 749 956 41
Servicing 4222697, 633 048 00
 12 V. 42 Amp.
 L. 158 mm, O.D. 86 mm, Shaft 17 mm



131642

Replacing 4215534, 749 661 11
Servicing 633 044 01, 633 045 00
 24 V. 47 Amp.
 L. 209 mm, O.D. 86 mm, Shaft 17 mm



131944

Replacing 749 871 71
Servicing 633 071 00, -01, -03, -05, 633 087 01
 12 V. 55 Amp.
 L. 156 mm, O.D. 89 mm, Shaft 17 mm

Replacing MAGNETI MARELLI



131952

Replacing 836 006 61
Servicing 633 200 03, -23, 633 210 02, -41, -42
 12 V. 55 Amp.
 L. 152 mm, O.D. 89 mm, Shaft 17 mm



132338

Replacing 749 672 51
Servicing A108: 633 005 06, -26, 633 008 01, -02, -12, -21, 633 009 00, -01, -02, -07, -17, -20, -21, -31, -32
 12 V. 33 Amp.
 L. 155.2 mm, O.D. 73.4 mm, Shaft 17 mm



134796

Replacing 8190466, 836 023 21
Servicing AA125 R: 633 200 25, 633 210 45, -46, -47, -48, -49, -50, -52, -55, -63
 24 V. 30 Amp.
 L. 151 mm, O.D. 89 mm, Shaft 17 mm

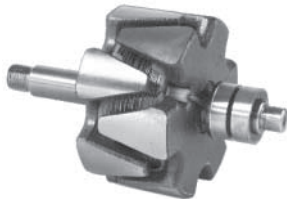

131953

Replacing 836 019 01
Servicing 633 200 15, -22, 633 210 19, -20
 12 V. 65 Amp.
 L. 152 mm, O.D. 89 mm, Shaft 17 mm



133845

Servicing A127: 633 241 88, 633 243 16, -74
 12 V. 55/70 Amp.
 L. 202 mm, O.D. 89.5 mm, Shaft 17 mm, 18 splines
Shaft: Cargo 135244, Nut: Cargo 135049



134904

Replacing 749 868 41
Servicing 633 058 02, -22, 633 078 02, -22
 12 V. 65 Amp.
 L. 163 mm, O.D. 89 mm, Shaft 17 mm



131954

Replacing 836 016 41, 836 088 81
Servicing AA125R 14V-60: 633 210 23, -64, 633 211 70
 12 V. 65 Amp.
 L. 141.5 mm, O.D. 89 mm, Shaft 17 mm



134414

Replacing 836 026 31
Servicing AA125R: 633 200 21, 633 210 35, -36, -37
 12 V. 45 Amp.
 L. 151 mm, O.D. 89 mm, Shaft 17 mm

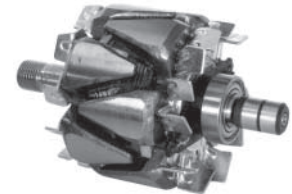

136674

Replacing 836 106 01, 836 150 91
Servicing A115i: 633 202 00, -03, -04, -27, -38, 633 212 00, -04, -05, -33, -34
 12 V. 65/85 Amp.
 L. 153 mm, O.D. 91.3 mm, Shaft 17 mm
Slip ring: Cargo 138441

Replacing MAGNETI MARELLI



136982

Replacing 54208671
Servicing 63324406, -24299
 24 V. 30 Amp.
 L. 143.7 mm, O.D. 89.5 mm, Shaft 17 mm



139465

Replacing 54206538, 54207164
Servicing A127: 633 241 21, -58,
 633 242 02, -09, -17, -20, -31, -45, -57,
 -74, -88, -94, 633 243 08, -11, -34, -87
 12 V. 65/70 Amp.
 L. 143.9 mm, O.D. 89.5 mm, Shaft 17 mm

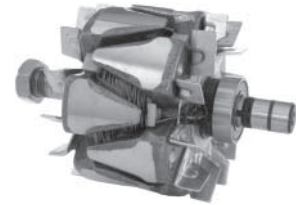

235225

Replacing 855 629 110 
Servicing A127ir: 633 214 91, 633 215 07,
 633 218 58, -59
 12 V. 120 Amp.
 L. 160 mm, O.D. 99.5 mm, Shaft 17 mm

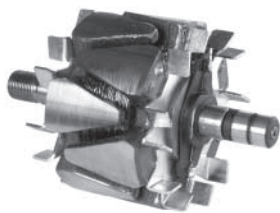

137335

Replacing 855 613 11, 855 614 01
Servicing A127i: 633 212 29, -31, -32,
 -37, -41, -45, -61, 633 213 10, -21, -31,
 -33, -43, -44, -45, -46, -47, -49, -52, -53
 12 V. 100 Amp.
 L. 160 mm, O.D. 99.5 mm, Shaft 17 mm

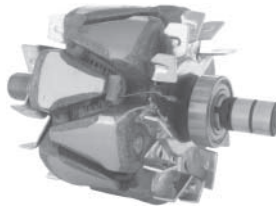

233659

Replacing 855 615 11 
Servicing A27ir: 633 202 79, 633 213 89,
 -98, 633 214 26
 12 V. 85 Amp.
 L. 159.5 mm, O.D. 99.5 mm, Shaft 17 mm

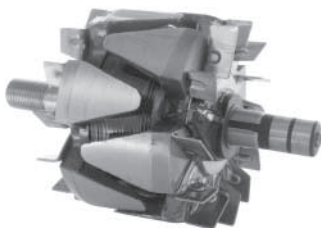

138464

Replacing 855 613 21, -91
Servicing A127i: 633 212 53, -99,
 633 213 13, -16, -28, -32, -40, -55, -97,
 633 214 02, -06, -19, -23, -49, -53, -61
 12 V. 85 Amp.
 L. 160 mm, O.D. 99.5 mm, Shaft 17 mm



235172

Replacing 855 630 21 
Servicing A127im: 633 218 14, -15, -16
 12 V. 140 Amp.
 L. 160 mm, O.D. 99.5 mm, Shaft 17 mm

Replacing MAGNETI MARELLI

Rotor Parts



132080 A
M17-1.5
Rotor shaft nut set



135049 Std pkg 10 **A**
Servicing A127: Cargo 133845
9/16"
Rotor shaft nut



234628 
Servicing 633 213 89, -98, 633 214 26
M17-1.5
Anti CW rotation
Rotor shaft nut



135244
Servicing A127, Cargo 133845
L. 202 mm, Shaft 17 mm, 18 splines
Rotor shaft



130813 Std pkg 10 **A**
Replacing 4474592, 4152612
3 x 5 x 13 mm
Key



130936 Std pkg 10 **A**
Replacing 10202310
4 x 5 x 12.65 mm
Key



133784 Std pkg 10 **A**
3 x 6.5 x 16 mm
Key

Stators



138171
Replacing 836 083 51
Servicing A115i: 633 202 00, -53,
633 205 00, 633 212 00
12 V. 65 Amp. w/ Bracket D.E.
Stator only: Cargo 139956
Bracket only: Cargo 230223

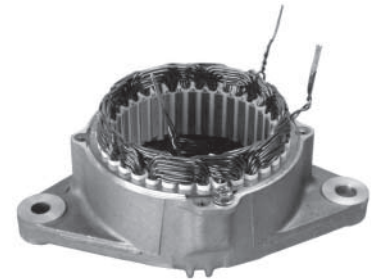

138454
Replacing 836 124 71
Servicing A115i: 633 212 77, -78,
633 213 11, 633 216 10, -11,
12 V. 65 Amp.
W/ Bracket D.E.
Stator only: Cargo 139956



138456
Replacing 836 085 41
Servicing A115i: 633 212 75, -82
633 216 15, -16, -55, -60, -61
12 V. 55/65 Amp.
W/ Bracket D.E.
Stator only: Cargo 139956

Replacing MAGNETI MARELLI

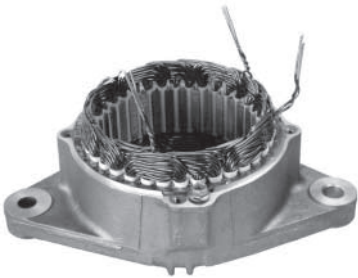

138457

Replacing 836 134 21
Servicing A115i: 633 216 13, -40
 12 V. 55/75 Amp.
 W/ Bracket D.E.
Stator only: Cargo 233598



138950

Replacing 836 165 41
Servicing A115i: 633 216 30, -31
 12 V. 65/85 Amp.
 W/ Bracket D.E.
Stator only: Cargo 231432

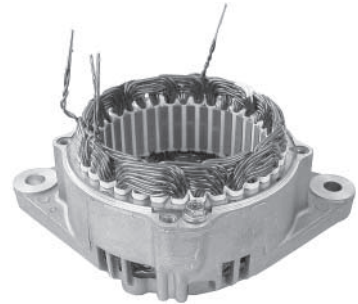

230812

Replacing 836 091 70, -71
Servicing A115i: 633 212 05, -76,
 633 213 61, 633 216 17, -20
 12 V. 75 Amp.
 W/ Bracket D.E.
Stator only: Cargo 233598
Bracket only: Cargo 231994



138506

Replacing 836 113 91
Servicing A115i: 633 212 52, -83,
 633 213 96, 633 216 08, -09, -25
 12 V. 65/85 Amp.
 W/ Bracket D.E.
Stator only: Cargo 139956
Bracket only: Cargo 234203



139101

Replacing 836 153 41
Servicing A127im: 633 213 51,
 633 413 51
 12 V. 85 Amp.
 W/ Bracket D.E.

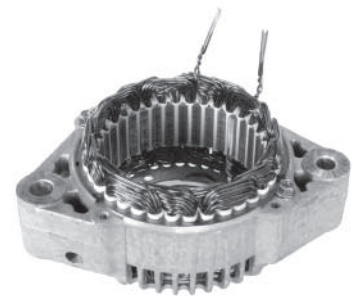

231008

Replacing 836 127 61
Servicing A115i: 633 212 39, 633 412 39
 12 V. 85 Amp.
 W/ Bracket D.E.
Stator only: Cargo 231432
Bracket only: Cargo 230226



138508

Replacing 836 136 51
Servicing A115i: 633 216 06, -07
 12 V. 75 Amp.
 W/ Bracket D.E.
Stator only: Cargo 139956

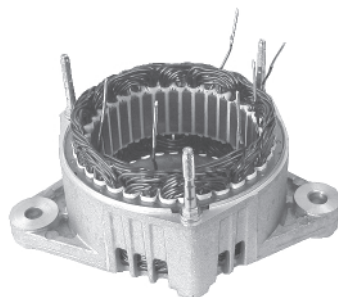

230143

Replacing 54209326
Servicing A127i: 633 212 29, -37,
 633 214 05
 12 V. 100 Amp.
 W/ Bracket D.E.
Stator only: Cargo 137224



231010

Replacing 836 165 51
Servicing A115i: 633 216 26
 12 V. 65 Amp.
 W/ Bracket D.E.
Stator only: Cargo 139956

Replacing MAGNETI MARELLI

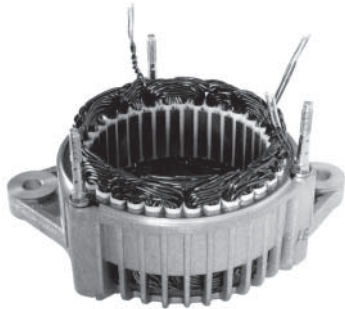

231028

Replacing 836 175 91
Servicing A127ir: 633 213 95
 12 V. 100 Amp.
 W/ Bracket D.E.
Stator only: Cargo 232785

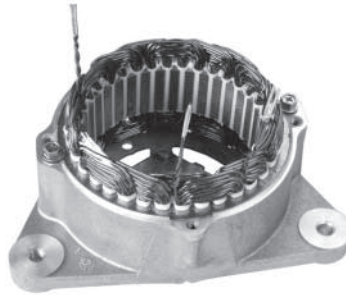

231038

Replacing 836 137 81, 836 205 81
Servicing A115i: 633 212 57,
 633 214 66, 633 414 66, 633 416 66, -95
 12 V. 100 Amp.
 W/ Bracket D.E.
Stator only: Cargo 139956
Bracket only: Cargo 230224



234898

Replacing 836 249 41 
Servicing A115i: 633 214 44, 633 216 78,
 633 217 24, -30, -46, 633 417 46
 12 V. 85 Amp.
 W/ Bracket D.E.
Stator only: Cargo 233344
Bracket only: Cargo 230225



231033

Replacing 836 190 01
Servicing A115i: 633 216 41
 12 V. 65 Amp.
 W/ Bracket D.E.
Stator only: Cargo 139956



231039

Replacing 836 156 21
Servicing A115i: 633 213 56,
 633 217 04, 633 417 04
 12 V. 80 Amp.
 W/ Bracket D.E.
Bracket only: Cargo 230227



130097

Replacing 748 776 51
Servicing A108: 633 005 06, -15,
 633 009 05, -25
 12 V. 28 Amp.
 O.D. 108.9 mm, I.D. 73.8 mm, W. 22.5 mm

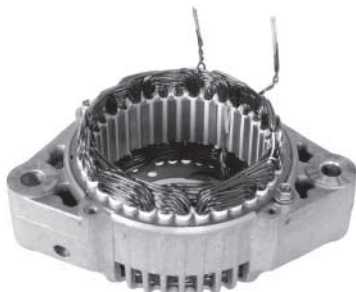

231036

Replacing 542 204 00
Servicing A115i: 633 212 38, 633 412 38
 12 V. 65 Amp.
 W/ Bracket D.E.
Stator only: Cargo 139956
Bracket only: Cargo 230226



231040

Replacing 836 148 31
Servicing A115i: 633 213 48,
 633 217 05, 633 417 05
 12 V. 80 Amp.
 W/ Bracket D.E.
Stator only: Cargo 231432
Bracket only: Cargo 230228



130187

Replacing 4305655, 749 653 21
Servicing A124: 4306041, 4475303
 12 V. 42 Amp.
 O.D. 124.2 mm, I.D. 86.5 mm, W. 20.7 mm

Replacing MAGNETI MARELLI



130221

Replacing 4274764, 749 920 11
Servicing A108, AA108: 633 009 02, 633 609 00, -01, 633 620 05, -06
 12 V. 33 Amp.
 O.D. 108.6 mm, I.D. 73.5 mm, W. 20.5 mm



131131

Replacing 4178621, 749 996 81
Servicing A12MD: 4178617, 4178618, 4180304, 633 044 00, -01, -10, -20, -30, -31, -90
 24 V. 50 Amp.
 O.D. 124.6 mm, I.D. 87 mm, W. 68.2 mm



131647

Replacing 748 763 01, -11
Servicing AA125: 633 054 01, 633 056 90, 633 074 00, -01, -02, -05, -06, -07
 12 V. 55 Amp.
 O.D. 125.6 mm, I.D. 88.9 mm, W. 23.9 mm



130363

Replacing 4149593, 749 952 81
Servicing A12M: 4149590, 4152101, 4152612, 4181511, 4205498, 4222697, 4474904
 12 V. 42 Amp.
 O.D. 124.1 mm, I.D. 86.1 mm, W. 24.2 mm



131229

Replacing 748 775 71, 748 784 21
Servicing AA125: 633 050 00, 633 051 00, -01, -03, 633 071 00, -01, -06
 12 V. 45 Amp.
 O.D. 125.6 mm, I.D. 89.2 mm, W. 23.8 mm



131648

Replacing 836 015 41
Servicing AA125T: 633 200 30, 633 210 03, -05, -08, -11, -60
 12 V. 55 Amp.
 O.D. 125.5 mm, I.D. 89.1 mm, W. 23.5 mm



130365

Replacing 4150782, 749 993 71
Servicing A12M: 4150779, 4152610, 4220357, 4223787, 4278696, 4474592, 4474902
 24 V. 26 Amp.
 O.D. 124.7 mm, I.D. 86.1 mm, W. 21.2 mm



131388

Replacing 836 025 51, 836 062 41
Servicing AA125R: 633 083 00, 633 200 25
 24 V. 30 Amp.
 O.D. 125.4 mm, I.D. 88.8 mm, W. 24 mm



131976

Replacing 836 015 31
Servicing AA125R: 633 210 00, -01, -04, -36, -37
 12 V. 45 Amp.
 O.D. 125.6 mm, I.D. 89.1 mm, W. 24.1 mm

Replacing MAGNETI MARELLI



131977

Replacing 836 027 61
Servicing AA125R: 633 200 15, -18, -22, 633 210 19, -20
 12 V. 65 Amp.
 O.D. 125.6 mm, I.D. 88.9 mm, W. 27 mm



135619

Replacing 836 044 31
Servicing AA125R: 633 200 41, -59, -96, 633 210 83, 633 211 14, -70
 12 V. 60 Amp.
 O.D. 125.7 mm, I.D. 88.9 mm, W. 26.7 mm



231432

Servicing A115i: 633 213 48, 633 216 93, 633 217 05, 23100-2F200, -201, -210
 12 V. 80 Amp.
 O.D. 117.9 mm, I.D. 91.3 mm, W. 29.4 mm



132370

Replacing 748 773 51
Servicing AA125: 633 060 00, 633 063 00, 633 083 00
 24 V. 30 Amp.
 O.D. 125.6 mm, I.D. 88.9 mm, W. 23.4 mm

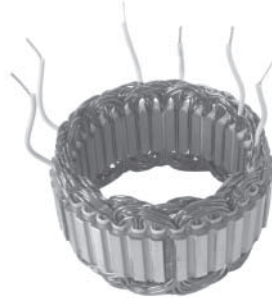

137224

Servicing A127iR: 633 214 53, -61
 12 V. 85/100 Amp.
 O.D. 129.7 mm, I.D. 100 mm, W. 33 mm



231491

Servicing A127i, A127ir: 633 202 77, 633 213 28, -40, 633 215 07
 12 V. 120 Amp.
 O.D. 130 mm, I.D. 100 mm, W. 33.6 mm



132380

Replacing 749 857 31, 749 855 81
Servicing AA125C: 633 067 00, -01, -21, 633 087 01, -31
 12 V. 45 Amp.
 O.D. 125.6 mm, I.D. 89 mm, W. 18.1 mm



139956

Servicing A115i: 633 212 00, -33, -38, -44, -70, 633 216 00, -26, -69, -91, 633 217 24, 633 412 38, -44
 12 V. 65 Amp.
 O.D. 118.2 mm, I.D. 92 mm, W. 30.8 mm



232785

Servicing A127i: 633 202 89, 633 213 21, -33, 633 413 21, -53
 12 V. 100 Amp.
 O.D. 130 mm, I.D. 100 mm, W. 33 mm

Replacing MAGNETI MARELLI



233344

Replacing 836 218 21
Servicing A115i: 633 216 78, 633 217 46, 633 416 79
 12 V. 90 Amp.
 O.D. 118 mm, I.D. 91.4 mm, W. 29.4 mm



233598

Servicing A115i: 633 212 05, -76, 633 213 61, 633 216 03, -04, -17, -20, -58, 633 217 23
 12 V. 75 Amp.
 O.D. 118 mm, I.D. 92 mm, W. 29.5 mm



234816

Servicing A127i: 633 202 28, 633 212 40, 633 412 40
 12 V. 120 Amp.
 O.D. 130 mm, I.D. 100 mm, W. 33 mm



Brackets D.E.



132583

Replacing 749 655 11, 749 913 01
Servicing A12M124: 633 031 00, -10, -90, 633 032 00, -90, 633 033 00, -80, -90, 633 035 00, -11, -81, 633 037 80, 633 041 00, -20
 W/ bearing



134357

Replacing 748 792 61, 9983719
Servicing AA125, E: 633 052 06, 633 055 06, 633 063 00, 633 075 26, 633 083 00
 W/ bearing



134415

Replacing 836 007 21, 9939968
Servicing AA125R: 633 200 04, -05, -10, -28, -56, -91, 633 210 03, -04, -05, -13, -15, -58, 633 211 09, -59
 W/ bearing



134417

Replacing 836 001 01, 9940007
Servicing AA125R: 633 200 01, 633 210 00
 W/ bearing



134419

Replacing 836 009 41, 9940294
Servicing AA125R: 633 200 07, -08, -31, 633 210 08, -09, -10, -11, -29, -61, -71
 W/ bearing



134420

Replacing 836 023 61, 8190465
Servicing AA125R: 633 200 21, -23, -25, 633 210 19, -20, -28, -35, -36, -37, -40, -41, -42, -45, -46, -47, -48, -49, -50, -52, -55, -63
 W/ bearing

Replacing MAGNETI MARELLI



134426

Replacing 748 772 71, 9935392
Servicing AA125: 633 051 01, 633 054 01
 W/ bearing



135146

Replacing 836 021 91
Servicing AA125R: 633 200 18, -32, -42, -44, 633 210 24, -25, -86
 W/ bearing



138799

Replacing 836 070 21
Servicing AA125R: 633 200 94, 633 211 65, -71
 W/ bearing



134614

Replacing 9940296, 836 022 31
Servicing AA125R: 633 200 13, 633 210 17, -64, -72, -77
 W/ bearing



136725

Replacing 836 069 21
Servicing AA125R: 633 200 48, -55, -82, -83, 633 201 32, 633 210 91, -98, 633 211 08, -49, -50, -51, -56, -57
 W/ bearing



139095

Replacing 836 044 51
Servicing 633 210 83, 633 211 14, 633 200 41, -59
 W/ bearing



134666

Replacing 9934953, 748 765 91
Servicing AA125: 633 050 00, 633 051 00, 633 053 00, 633 054 00, -05, 633 056 01
 W/ bearing



137166

Replacing 749 876 91
Servicing AA125E: 633 074 01, -31, -41
 W/ bearing



230223

Servicing A115i: 633 212 00, 633 216 00, 633 217 12, -42
 Fiat
 Bearing: Cargo 140087

Replacing MAGNETI MARELLI



230224

Servicing A115i: 633 212 57,
633 214 25, 633 216 66, -95
Ford
Bearing: Cargo 140093



230227

Servicing A115i: 633 216 92
Nissan
Bearing: Cargo 140093



231538

Servicing A127i: 633 203 33, 633 214 19
Bearing: Cargo 140263



230225

Servicing A115i: 633 212 44,
633 216 69, 633 217 24
Ford
Bearing: Cargo 140093



230228

Servicing A115i: 633 216 93
Nissan
Bearing: Cargo 140093



231994

Servicing A115i: 633 212 05,
633 216 17, -20
Bearing: Cargo 140093



230226

Servicing A115i: 633 212 38,
Rover
Bearing: Cargo 140093



230674

Servicing 633 203 09, 633 213 24, -58,
633 214 22, 633 400 04
Bearing: Cargo 140093



233769

Replacing 836 141 91
Servicing A127i: 633 212 31
Bearing: Cargo 140093

Replacing MAGNETI MARELLI



233804

Servicing A115i: 633 216 79, 633 416 79
Bearing: Cargo 140093



234633

Servicing A127ir: 633 213 89, -98,
 633 214 26
Bearing: Cargo 140093

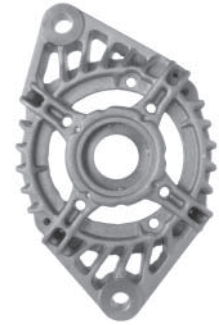

235021

Servicing A115im: 633 217 29,
 633 218 09, -19, -26, -33, -36
 W/ bearing plate
Bearing: Cargo 140093



234203

Servicing A115i: 633 212 52, -53,
 633 213 96, 633 216 08, -09, -25
Bearing: Cargo 140093

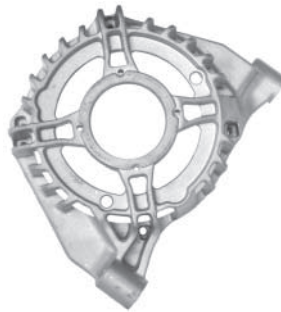

234638

Servicing A115i: 633 217 75
Bearing: Cargo 140093



235029

Replacing 836 234 81
Servicing A115i: 633 216 58, 633 217 02,
 633 416 58, 633 417 02
Bearing: Cargo 140093

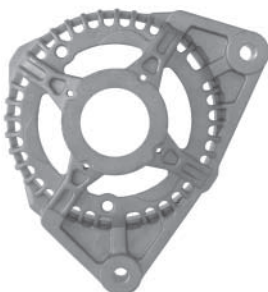

234566

Servicing A115i: 633 217 46,
 633 218 23, -98, 633 417 46, 633 774 04
Bearing: Cargo 140093

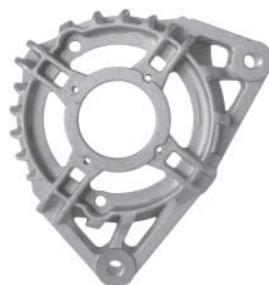

235010

Servicing 633 217 11, -58, -78, 633 417 11
Bearing: Cargo 140093

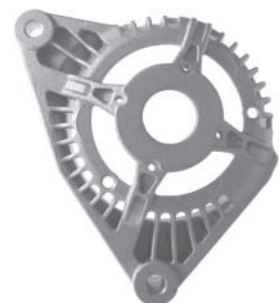

235128

Servicing A115i: 633 216 71, 633 217 23
Bearing: Cargo 140093



Replacing MAGNETI MARELLI

Brackets S.R.E.

235182

Servicing A115i: 633 216 26, -1713, -1747, -1763, -1788, -1867
Bearing: Cargo 140093



235344

Servicing A115i: 633 216 41, -1770, 633 416 41, -1770
Bearing: Cargo 140093



138475

Replacing 836 213 41
Servicing A115i: 633 216 03, -04
 12 V.
 W/ rectifier and regulator
Bracket only: Cargo 231321

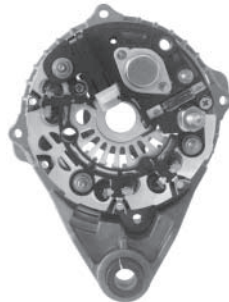

138564

Replacing 836 213 91
Servicing A115i: 633 216 15, -16, -55, -60, -61, 633 217 76
 12 V.
 W/ rectifier and regulator
Bracket only: Cargo 231992

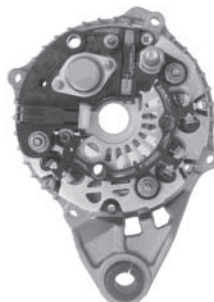

138650

Replacing 836 213 51
Servicing A115i: 633 216 06, -07
 12 V.
 W/ rectifier and regulator
Bracket only: Cargo 138951

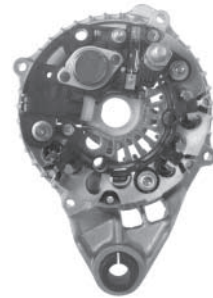

138651

Replacing 836 213 61
Servicing A115i: 633 216 08, -09, -25, -32
 12 V.
 W/ rectifier and regulator
Bracket only: Cargo 138951



138653

Replacing 836 214 01
Servicing A115i: 633 216 17, -20
 12 V.
 W/ rectifier and regulator
Bracket only: Cargo 231992

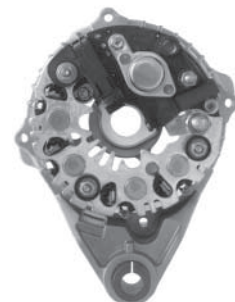

138654

Replacing 836 217 31
Servicing A115i: 633 216 18
 12 V.
 W/ rectifier and regulator

Replacing MAGNETI MARELLI



139096

Replacing 836 134 81
Servicing A115i: 633 212 77, -78, 633 213 11
 12 V.
 W/ rectifier and regulator

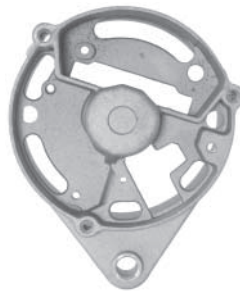

134356

Replacing 748 765 01
Servicing AA125: 633 050 00, 633 052 06, 633 053 00, 633 054 00, 633 054 05, -06, -24, 633 055 06, 633 074 30



134424

Replacing 836 023 41, 9940295
Servicing AA125R: 633 200 08, -21, -23, -25, 633 210 09, -10, -11, -29, -35, -36, -37, -40, -41, -42, -45, -46, -47, -48, -49, -50, -52, -55, -63, -71



139312

Replacing 836 189 81
Servicing A115i: 633 216 41, -71, 633 416 41, -71
 12 V. 65 Amp.
 W/ rectifier and regulator

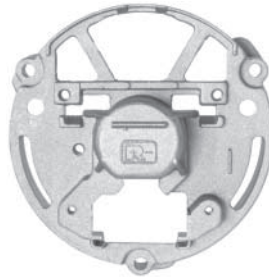

134421

Replacing 836 000 61, 9939958
Servicing AA125R: 633 200 01, 633 200 02, 633 210 00, 633 211 13



134789

Replacing 749 849 31
Servicing AA125: 633 037 01, 633 063 00



134352

Replacing 748 772 41
Servicing AA125: 633 051 01, -03



134422

Replacing 836 032 11, 9940859
Servicing AA125R: 633 200 04, -06, -10, -28, 633 210 03, -04, -05, -06, -07, -13, -15, -58



137789

Replacing 836 033 11
Servicing AA125R: 633 200 55, 633 211 08

Replacing MAGNETI MARELLI



138473

Replacing 836 084 71
Servicing A115i: 633 212 00, -33, -34



231241

Servicing A115i: 633 212 44,
 633 216 69, -91, 633 217 24, 633 412 44



231324

Replacing 836 235 81
Servicing A115i: 633 216 00, -02,
 633 217 42



138951

Replacing 836 159 91, 836 236 31
Servicing A115i: 633 216 06, -07, -08,
 -09, -25, -30, -31, -32
 12 V.



231242

Servicing A115i: 633 212 57,
 633 214 25, 633 216 36, -66



231326

Replacing 836 238 41
Servicing A115i: 633 216 26, -27

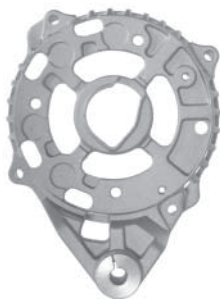

231240

Replacing 836 235 01
Servicing A115i: 633 416 95

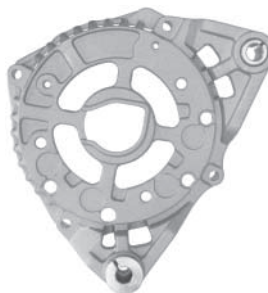

231243

Servicing A115i: 633 217 30, -30A



231342

Servicing A127: 633 213 58
Bearing: Cargo 140273

Replacing MAGNETI MARELLI



231992

Servicing 633 216 15, -16, -17, -20, -61



234226

Servicing A115i: 633 212 35, 633 213 00
Bearing: Cargo 141071



231993

Servicing 633 212 38, -39,
633 412 38, -39



233899

Servicing 633 217 11, 633 417 11
Bearing: Cargo 141071



234282

Servicing A127i: 633 203 33,
633 212 46, 633 213 10, -15, -16, -49, -55,
633 214 18, -19, -36, -97, 633 215 01, -06,
633 218 00
Bearing: Cargo 140273



233126

Replacing 836 183 31
Servicing A127ir: 633 203 34, -35, -36,
-38, -39, -48, -49, 633 213 24, -43, -44, -45,
-46, -47, 633 214 22, -61, -62, -66, -73,
540 225 49
Bearing: Cargo 141071



234176

Servicing A127i: 633 203 05,
633 212 27, -29, 633 214 05
Bearing: Cargo 140273

234283

Servicing A115i: 633 216 79, 633 416 79
Bearing: Cargo 141071

Replacing MAGNETI MARELLI



234336

Servicing A115i: 633 217 05
Bearing: Cargo 141071



234639

Replacing 836 216 61 
Servicing A115i: 633 216 78, 633 217 46,
 633 218 23, -98, 633 41 678, 633 417 46,
 63377404
Bearing: Cargo 141071

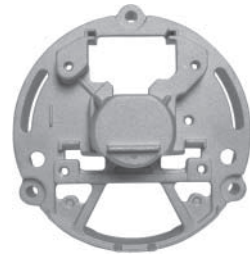

235119

Replacing 836 047 61, 836 047 91 
Servicing A125r: 633 200 39, -20101,
 633 210 81, -082, -083, -170, 633 211 78,
Bearing: Cargo 140081



234415

Servicing A115i: 633 203 08,
 633 213 56, 633 216 95, 633 217 04
Bearing: Cargo 140273



234730

Servicing A127ir: 633 215 07,
 633 218 01, -02, -03, -04, -59
Bearing: Cargo 141071



235137

Servicing A115im: 633 217 29, 633 218 09,
 -19, -33, -36 



234416

Servicing A127i: 633 203 17,
 633 214 34, 633 414 34
Bearing: Cargo 141071



235034

Replacing 836 201 91 
Servicing A115i: 633 205 45, 633 216 58,
 633 217 02, 633 416 58, 633 417 02
Bearing: Cargo 141071

Replacing MAGNETI MARELLI

Bracket Parts



132572 A
Mounting bushing kit for M12 bolt,
L. 29 mm



139747
Servicing 633 212 44, 633 216 69, -91,
633 217 24, 633 412 44
8.85 x 13.5/24.2 x 25.2 mm
Mounting bushing, S.R.E.



231137
Servicing AA125R
I.D. 24 mm
Bearing retainer



134782 Std pkg 10
12 x 19.7 x 22 mm
Mounting bushing, S.R.E.



139966 Std pkg 5
10 x 15 x 13 mm
Mounting bushing, D.E.

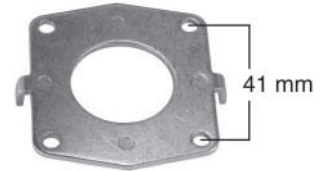

232059 Std pkg 5
Servicing A115i
I.D. 28 mm
Bearing retainer



134783 Std pkg 10
12 x 19.5 x 16.2 mm
Mounting bushing, D.E.



232063 Std pkg 5
Servicing A115i
8.8 x 15/21.2 x 25 mm
Mounting bushing, S.R.E.

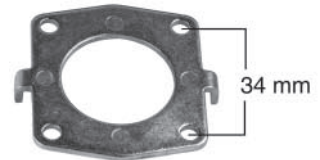

232060 Std pkg 5
Servicing A115i
I.D. 28 mm
Bearing retainer



134964 Std pkg 5 A
10 x 15 x 18 mm
Mounting bushing, D.E.

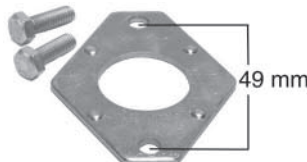

231136
Servicing AA125R
I.D. 23.5 mm
Bearing retainer



234041
Servicing 633 213 89, -95, -98,
633 413 58
I.D. 30.1 mm
Bearing plate

Replacing MAGNETI MARELLI

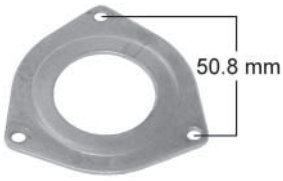

234714

Servicing A127i: 633 203 33, 633 212 32, -41, -45, -46, 633 213 10, -13, -15, -16, -49, -55, 633 214 12, -18, -19, -23, -36, -97, 633 215 01, -06, -07, 633 218 00, -01, -02
I.D. 30 mm
Bearing plate



137583

Servicing 633 212 57, 633 214 25
O.D. 37 mm, I.D. 35 mm, L. 14 mm
Bearing tolerance ring



231871 Std pkg 10

M5 x 37.5 mm
KNURL O.D. 6.3 mm
Screw for S.R.E. Bracket



139866 Std pkg 5

Servicing A127ir
O.D. 37 mm, I.D. 35 mm, L. 14/18 mm
Bearing cap

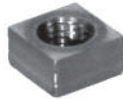

139748

Servicing 633 212 44, 633 216 69, -91, 633 217 24, 633 412 44
M8/12.7 x 6.6 mm
Nut for S.R.E. Bracket



139952 Std pkg 25 **A**

Servicing A115i
O.D. 37 mm, I.D. 35 mm, L. 14 mm
Bearing cap



232061 Std pkg 5

Servicing A115i
Spring clip for S.R.E. Bracket



231827 Std pkg 5

Servicing 633 216 79
O.D. 36.8/41.6 mm, I.D. 35/17.8 mm,
W. 18.8 mm
Bearing cap



231870 Std pkg 10

M5 x 33.3 mm
KNURL O.D. 6.3 mm
Screw for S.R.E. Bracket

Replacing MAGNETI MARELLI

Covers



132244 Std pkg 5
Replacing 9934601
Servicing A108: 633 005 15, 4376714



132630 Std pkg 5
Replacing 748 805 71
Servicing AA125: 633 054 00, -01, -04, -06, -20, -24, -26, -30, -31, -36, -40, -46, 633 056 40
 Red



136430
Replacing 836 084 00
Servicing A115i: 633 212 00



132245 Std pkg 5
Replacing 9934954
Servicing AA125: 633 051 00, -01, -02, -20, -22, -30, -31, 633 052 06, -26, -36, -46, 633 060 00, -10, -20, -30, -40, -50, -60, -70, -79, -80, -89, -90, -99
 White



133201
Replacing 855 600 11
Servicing AA125R: 633 210 57



137283
Servicing A127i: 633 203 09
 Clip on



132315
Replacing 836 038 21
Servicing AA125: 633 051 01, -31, 633 071 01, -31, 633 200 01, -02, -04, -07, -08, 633 054 01, 633 074 01, 633 210 00



135564
Replacing 836 177 41
Servicing AA125: 633 200 53, -55, -56, -58, -83, 633 201 12, 633 211 03, -08, -09, -10, -12, -51, -97, 633 214 03, -10



138356
Replacing 836 126 70
Servicing A127im: 633 202 89, 633 213 21, -33, -51, 633 413 21, -53

Replacing MAGNETI MARELLI



138852

Servicing A127i: 633 203 09, -15, 633 212 43, 633 412 43,



139531

Servicing A127i: 633 213 58, 633 400 04, Land Rover Discovery, Range Rover



139865

Replacing 836 149 10
Servicing A115i: 633 216 15, -16, -18



138891

Replacing 836 126 90, 836 131 51
Servicing A115i: 633 212 57



139622

Replacing 836 097 31
Servicing A115i: 633 212 35, -81, 633 213 64, 633 216 03, -04
W/o Plug cover: Cargo 231219



230372

Servicing 633 216 79, 633 416 79



139100

Replacing A115i: 836 149 00
Servicing 633 216 17

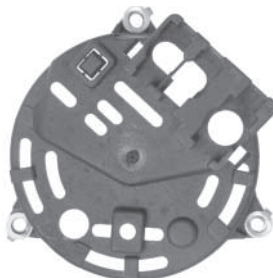

139855

Servicing 633 212 85, 633 213 24, 633 214 21, -22,



230537

Replacing 836 170 31
Servicing A115i: 633 212 87, 633 213 30, 633 216 10, -11, -12, -40

Replacing MAGNETI MARELLI



230677

Replacing 836 085 81
Servicing A115i: 633 212 52, -83, -95,
 633 216 06, -07, -25



230949

Replacing 855 626 61, 855 627 11
Servicing A115i: 633 213 48, -56,
 633 216 92, -93, 633 217 04, -05



231385

Servicing A127ir: 633 202 77,
 633 213 28



230756

Replacing 836 085 10
Servicing A115i: 633 212 04, -75, -82,
 633 213 62, -67, 633 216 61



231219

Servicing A115i: 633 212 35, -81,
 633 213 64, 633 216 03, -04
 W/ plug cover Cargo 139622



231430

Servicing A115i: 633 217 30, -30A, -30B,
 633 416 95



230948

Replacing 836 155 41
Servicing A127ir: 633 202 80,
 633 213 32, 633 214 53, -89



231239

Servicing A115i: 633 213 56,
 633 216 92, 633 217 04



231550

Replacing 836 210 091
Servicing A115i: 633 205 42,
 633 216 71, 633 416 71

Replacing MAGNETI MARELLI



231698

Servicing A115i: 633 205 42,
633 216 71, 633 416 71
W/o bushing



231905

Servicing A127ir: 633 213 47



232462

Replacing 836 100 91
Servicing A127i: 633 212 31, 63320225



231700

Replacing 836 156 01
Servicing A127i: 633 212 32, -41, -45,
633 213 13, 633 214 12



231991

Servicing A115i: 633 216 41



232463

Replacing 836 146 91
Servicing A115i: 633 216 13, 63320510



231812

Replacing 836 148 90
Servicing A115i: 633 205 00, -01, -02,
-22, -43, 633 216 00, -01, -02, -05, -26,-63



232175

Replacing 836 121 91, 836 167 71
Servicing A127i: 633 212 27



233500

Replacing 836 146 31, 836 155 71
Servicing A127i: 633 213 15, -49, -89,
-98, 633 214 02, -18, -23

Replacing MAGNETI MARELLI



233539

Servicing A115i: 633 212 05, -76, 633 213 61



234109

Servicing A127ir: 633 215 07, 633 218 01, -02, -04



234430

Servicing A115i: 633 218 48



233824

Servicing A115i: 633 217 11, 633 417 11



234327

Servicing A115im: 633 217 33, -34, -41



234431

Servicing A115im: 633 218 26, -33, -36



233882

Servicing A127: 633 24 273, -274, 54022336, -337



234429

Replacing 83616141
Servicing A127ir: 63320283, 63320345, 633 213 40, 63321401, 63321449, 63321490



234751

Replacing 542 093 31
Servicing A127i: 633 202 35, 633 212 53



Replacing MAGNETI MARELLI



234765

Replacing 836 131 51
Servicing A115i: 633 205 45, 633 216 58, 633 217 02



Regulators



130610

Replacing 4205243, RTT 110C,J
 24 V.
 Electronic



130652

Replacing 4475112, 648 081 40
Servicing AA125: 633 051 00, 633 052 06, 633 054 01, 633 057 01, 633 067 00
 12 V.



237963

Servicing A115im: 633 217 40



130613

Replacing 4296100
 12 V.
 Electronic



130653

Replacing 9983355, 648 081 41
Servicing AA125: 633 060 00, 633 063 00
 24 V.



130651

Replacing 648 081 30, RTT 113A
Servicing 633 035 01, -21, -81, 633 037 01, -20, -22, -80
 12 V.



130676

Replacing RTT110A, 648 080 10, -11, -12
 12 V.
 Slip ring O.D. 32 mm

Replacing MAGNETI MARELLI



131282

Replacing 648 081 32, RTT 113B
24 V.

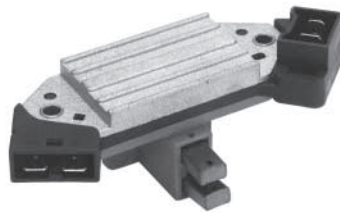

133956

Replacing RTT 118 C, 648 081 82
Servicing AA125R: 633 210 57
12 V.



138789

Replacing RTM153B, 836 171 81
Servicing A127im: 633 213 21, -33, -51,
-52, -53, -54, 633 412 40, 633 413 21,
-33, -51, -52, -53, -54
12 V.
W/ W-terminal M5

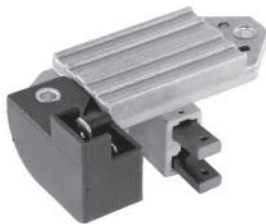

131283

Replacing 797 074 81, 836 001 51
Servicing AA125R-14V-65A: 633 200 . . . ,
633 210 . . . , 633 211 05
12 V.
Brush set: Cargo JX42 2

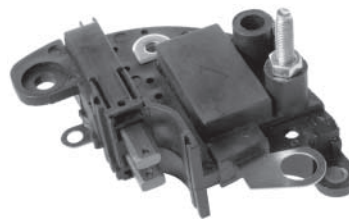

136432

Replacing RTM 121A, -151A, 855 630 51
Servicing AA115i, A127 IR: 633 202 00,
-03, -19, -27, -38, 633 212 00, -04, -33,
-34, -35, -52
12 V.



138794

Replacing RTT113AY, -C, 648 081 33
Servicing A108: 633 005 06, -26,
AA125, 633 056 01, -21, -40, -60, -90
12 V.

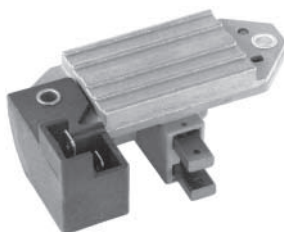

131286

Replacing 797 074 41, RTT 119B
24 V.
Brush set: Cargo JX42 2



136457

Replacing 24TR
Servicing A127i: 633 203 09, -15,
633 212 43, -85, 633 213 24, -58,
633 214 21, -22, 633 412 43
12 V.
W/o S-terminal
Brush set: Cargo 140895

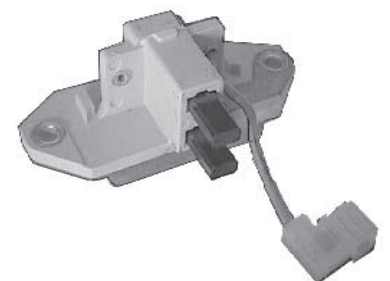

138795

Replacing 836 031 51
Servicing AA125R: 633 200 29,
633 210 59
12 V.

Replacing MAGNETI MARELLI



138796

Replacing 836 064 11
Servicing AA125R: 633 200 60,
 633 201 14, 633 211 15, -58, -61, -62, -63,
 -68, -81
 24 V.



139215

Replacing 28019
Servicing A127: 540 225 74,
 540 226 65, -93, 633 244 04
 12 V.

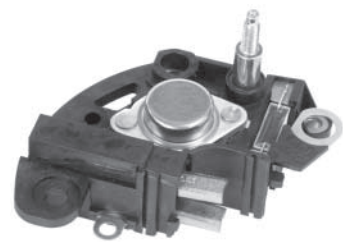

230800

Replacing 855 629 91, RTM 300.07
Servicing A115i, A127IM: 633 217 60,
 633 218 27, -38
 12 V.



138797

Replacing RTM24TR, 28017, 836 142 51
Servicing A127i: 633 212 37, -41, -45,
 -46, -53, -99, 633 213 13, -97, 633 214
 05, -06, -12
 12 V.



139651

Replacing 542 092 76
Servicing 540 224 43
 12 V.
 W/ battery sensor

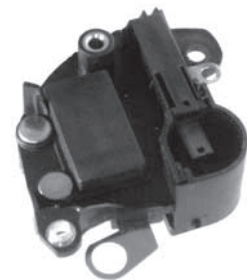

232636

Servicing A127: 54022667, -670
 24 V.

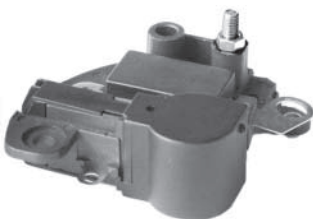

138798

Replacing RTM150B, 836 159 21
Servicing A127im: 633 212 61,
 633 412 61
 12 V.



230790

Replacing 855 625 41, 855 628 01
Servicing A115i: 633 216 78, -79,
 633 217 46, 633 416 79
 12 V.

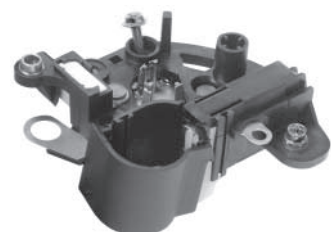

233634

Replacing 855 618 01, RTM 159B
Servicing A115i: 633 417 04, -05
 12 V.

Replacing MAGNETI MARELLI



233635

Replacing 836 318 91, 855 622 02
Servicing A115i: 633 412 38, -39,
 633 417 27
 12 V.

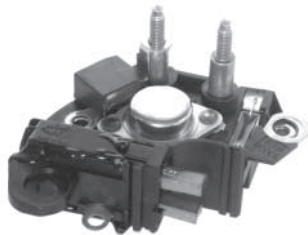

233636

Replacing 855 634 81, RTM 200.03
Servicing A115i: 633 416 58, 633 417 02
 12 V.

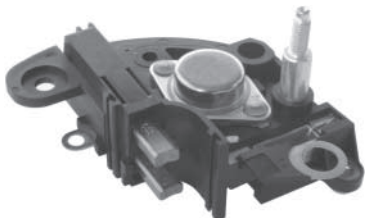

236579

Replacing 855 627 31, -628 81 
Servicing A127iM: 633 214 91, -94,
 633 215 07, 633 217 12, -13, -18, -61, -64,
 -65, -75, -76, -79, -80, -81, -82, -89, -90,
 -91, 633 218 14, -15, -16, -36, -39, -41, -48,
 -54
 12 V.

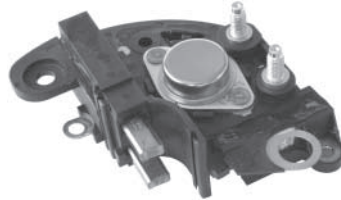

238265

Replacing 855 634 91 
Servicing A115im: 633 217 33, -34, -40,
 -41, 633 218 29
 12 V.

Regulator Parts



235288

Servicing 633 212 27, -31, -41, -45, -53,
 633 214 12 
 O.D. 13.14 mm, I.D. 9.55 mm, L. 26.25 mm

Replacing MAGNETI MARELLI

Rectifiers



130364

Replacing 749 990 91
Servicing A124: 4306041, 4475303,
 633 010 00, 633 033 80



131391

Replacing RDD15, 636 215 01, -03
Servicing AA125R: 633 210 00, -01, -03,
 -04, -05, -06, -07, -08, -09, -10, -11, -13,
 -41, -58, -60, -61, -67, -80, -95, 633 211 03
 W/ diode trio



131564

Replacing 749 655 01
Servicing A124: 633 032 . . , 633 042 . . ,
 633 033 . .
 W/ diode trio



130597

Replacing 749 864 11
Servicing A108: 633 005 06, -26,
 633 008 01, -02, -12, -21, 633 009 00, -01,
 -02, -07, -17, -20, -21, -31, -32

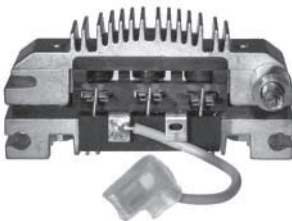

131505 HD

Replacing RDD16, 636 216 01, -03
Servicing 633 200 01, -13, -18, 633 201 01,
 633 210 21, -56, -57, 633 211 78
 w/ diode trio

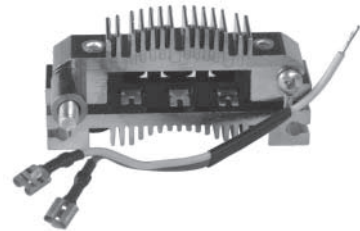

136077

Replacing RDD21, 636 221 01
Servicing AA125R: 633 200 39,
 633 210 81

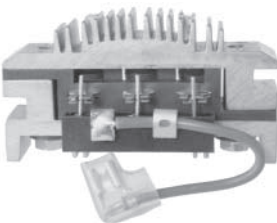

130650 HD

Replacing PRD4A, 648 260 40, 855 600 01
Servicing AA108: 633 005 15, 633 009 05,
 -25, 633 050 00, -20, 633 051 00, -01, -20,
 -30, -31, 0 633 052 06, -26, -36, 633 053 00,
 A125, AA125E: 633 058 01, -02, -22, -32,
 -42, -62, 633 074 08, -28, 633 076 02, -04
 W/ diode trio



131563

Replacing 4262908, 749 654 01
Servicing A12M: 633 030 . . , 633 031 . . ,
 633 035 . . , 633 037 . . , 633 040 . . ,
 633 041 . . , 633 042 . . , 633 048 . .



136423

Replacing RDD033, 636 233 01
Servicing A115i: 633 212 00, -04, -33,
 -34, -52, Fiat Punto
 B+ terminal M8

Replacing MAGNETI MARELLI



136458

Replacing 836 102 31
Servicing A127i, A127im: 633 212 27, -29, -31, -32, -37, -41, -45, -46, -53, -99, 633 213 13, -97, 633 214 05, -06
 B+ terminal M8 x 52 mm
Spacer: Cargo 235288



137695

Servicing A127i:
 B+ terminal M8 x 41 mm
Gasket: Cargo 230375



138377

Replacing RDD42, 636 242 01
Servicing A127ir: 633 213 10, -15, -16, -28, -31, -32, -35, -40, -49, -55, -90, -91, -98, 633 214 02, -18, -19, -23, -26, -53, -61
 B+ terminal M8

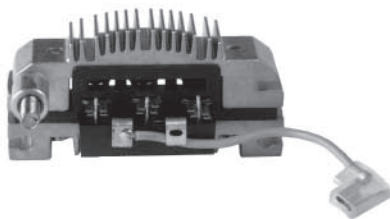

136675

Replacing RDD22, 636 220 01
Servicing AA125R: 633 200 46, 633 210 83, -84, -96
 W/ diode trio
 B+ terminal M6

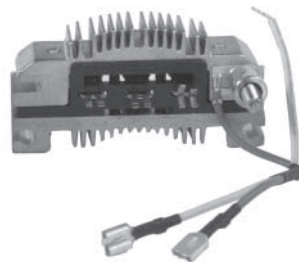

138120

Replacing RDD22, 633 222 01
Servicing AA125R: 633 200 41, 633 210 83, -84
 B+ terminal M6



138790

Replacing 636 236 01
Servicing A127im: 633 213 53, -54, 633 413 53, -54
 B+ terminal M8



136740

Servicing A127i: 633 203 03, 633 212 85, 633 213 24, 633 214 22
 W/ diode trio
 B+ terminal M6
Gasket: Cargo 230375



138376

Replacing RDD33, 636 238 01, 636 249 01
Servicing AA115i: 633 212 87, -92, 633 213 30, 633 216 01, -12, -18, -29, -30, -31, -63
 B+ terminal M8



138792

Replacing 636 236 02
Servicing A127im: 633 213 21, -33, -51, -52, 636 413 51, -52
 6 diodes
 B+ terminal M6

Replacing MAGNETI MARELLI



138800

Replacing RDD 37, 636 237 01
Servicing A127im: 633 212 40,
 633 412 40
 B+ terminal M8



139214

Replacing RDD35, -65, -75, 636 235 01
Servicing A115i: 633 212 05, -35, -70,
 -75, -76, -77, -78, -80, -81, -82, -83,
 633 213 00, -11, 633 216 00, -02, -03, -04,
 -05, -06, -07, -08, -09, -10, -11, -13, -15
 B+ terminal M8



231025

Replacing 636 250 02
Servicing A115i: 633 212 87, -92,
 633 216 00, -01, -04, -05, -06, -07, -08 ,
 -15, -16, -17, -18, -25, -26, -27, -29, -31,
 -60, 633 217 12, -13, -18, -29, -42, -44
 B+ terminal M8 x 37 mm



138801

Replacing RDD 42, 636 242 02
Servicing A127ir: 633 213 43, -44, -45,
 -46, -47, 633 214 66, -73, 633 413 43, -
 44, -45, -46, -47, -66
 B+ terminal M6

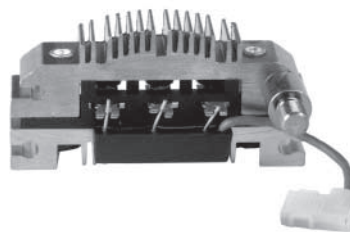

139218

Replacing RDD 29, 636 229 01
Servicing AA125r: 633 200 60,
 633 201 14, 633 211 15, -58, -61, -62, -63,
 -68, -80, -81
 B+ terminal M8



231026

Replacing 636 250 03
Servicing A115i: 633 217 44, 633 218 22,
 633 416 58, -95, 633 417 02, -30
 B+ terminal M6 x 30 mm



138802

Replacing 636 243 01
Servicing A127im: 633 212 61
 B+ terminal M8



230119

Replacing RDD 75: 636 248 02
Servicing A115i: 633 412 38, -39,
 633 416 66
 B+ terminal M6



233534

Servicing A115i: 633 213 48, -56,
 633 216 92, 633 217 04, -05
 B+ terminal M6 x 11.4 mm

Replacing MAGNETI MARELLI

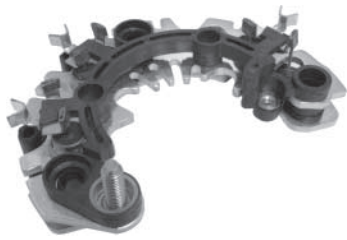

233792

Servicing A115i: 633 216 78, -79, 633 217 33, -41, -46, 633 218 23, 633 416 79, 633 417 46



234958

Servicing A115i: 633 212 39, 633 412 39
 4 terminals
 B+ terminal M6
 8 Diodes

Rectifier Parts



230375 Std pkg 5
Servicing A127i
 Gasket for rectifier 105 mm



232057 Std pkg 10
Servicing A115i
 O.D. 8.9/14.8 mm, I.D. 5.7 m, W. 7 mm
 Insulator for rectifier



232058 Std pkg 5
Servicing A115i
 O.D. 13 mm, I.D. 9.3 m, L. 13 mm
 Sleeve for rectifier

Diode Trios



131692 Std pkg 5
 200 V. 2.5 Amp.
 For rectifier Cargo 130650



131693 Std pkg 5 **A**
 For rectifier Cargo 130650
 w/ D+ connection
 200 V. 2.5 Amp.



230474
Servicing A115i

Replacing MAGNETI MARELLI

Slip Rings



133401 Std pkg 10 **A**
O.D. 32 mm, Shaft 17 mm, L. 22.3 mm
w/ 1.8 mm copper



133402 Std pkg 10 **A**
O.D. 28 mm, Shaft 17 mm, L. 22.1 mm
W/ 1.8 mm copper



138441 Std pkg 5
Servicing A115i, A127i
O.D. 16 mm, Shaft 6.8 mm
L. 46.5 mm

Brush Boxes



130703 **A**
Replacing 749 904 31, -51, 749 994 61
Servicing 633 030 00, -01, 633 031 91,
633 032 00, -02, -03, -13, -82, -90,
633 033 00, -11, -80, -91, 633 034 00, -09,
633 035 00, 633 040 03, 633 041 00
12/24 V. Complete w/ brushes



130704 **A**
Replacing 9935112, 748 766 41
Servicing 4379899
12 V. Complete w/ brushes



131554 **A**
Replacing 4305661, 749 655 31
Servicing 4304450, 4400747, 4403045,
4408631, 4474524, 4901478, 633 035
01, -02, -81, 633 036 10, 633 037 00, -01,
-02, -80, 633 045 00
12 V. Complete w/ brushes



131703
Replacing 9934596, 748 775 51
Servicing 4376714, 4382200, 4383251,
633 005 15, 633 050 00, 633 053 00
12 V. Complete w/ brushes

Brush Sets



140914 Std pkg 10
Servicing A127i
4.0 x 7.0 x 22 mm
12 V.



JX28-29 2 Std pkg 10
Replacing 4149619
7 x 5 x 12.3 / 11.7 mm
12 V.



JX30-31 2 Std pkg 10 **A**
Replacing 4230515
8 x 5 x 16 / 14.5 mm
12/24 V.



JX32 2 Std pkg 10 **A**
Replacing 4274790
8 x 5 x 15 / 13.5 mm
12/24 V.

Replacing MAGNETI MARELLI

Also see Bearing Chapter
and Pulley Survey



JX37-39 2 Std pkg 10
Replacing 4305661
 8 x 5 x 16 / 14.5 mm
 12/24 V.



JX42 2 Std pkg 10 **A**
Replacing 7970502.1
 7.2 x 4.2 x 17.7 mm
 12 V.

Special Bearings



140116 Std pkg 10 **A**
Replacing 9923271, 394737A
 12/28 x 12 mm



140265 Std pkg 5 **A**
Replacing 62202 2RS1
Servicing 633 009 05
 15/30 x 14 mm



140266 **A**
Replacing 24940240, 62303 2RS1
 17/47 x 19 mm



141071 Std pkg 10
Replacing BB1-3036 SKF
 16.96/34.97 x 9.94 mm

Fan & Pulleys



132313
Replacing 749 871 00
Servicing AA125R
 O.D. 135 mm, Bore 17 mm



132569
Replacing 748 771 00
Servicing AA124
 O.D. 137 mm, Bore 15 mm



131204
Replacing A628T20670, -56470
Servicing A3T32872, -33272
 O.D. 72.7 mm, Bore 15 mm, W. 20.6 mm,
 Single



133404
Servicing AA125R: 633 200 048
 O.D. 60.1 mm, Bore 17 mm, W. 21.4 mm,
 4 grooves

Also see Pulley Survey
page 809

Replacing MAGNETI MARELLI



133876

Servicing 633 078 01, 633 200 18, -32, -42, -44
O.D. 64.3 mm, Bore 17 mm, W. 32 mm, 5 grooves



139074

Replacing 855 610 51
Servicing A115i: 633 212 83, 633 216 06, -07, -25
O.D. 60.1 mm, Bore 17 mm, W. 35.4 mm, 5 grooves



139219

Replacing 836 077 20, 855 610 81
Servicing A115i: 633 212 75, -76, 633 213 61, -62, 633 216 16, -17, -20
O.D. 62.5 mm, Bore 17 mm, W. 25.8 mm, 5 grooves



135742

Servicing 633 200 40
O.D. 59.9 mm, Bore 17 mm, W. 23.6 mm, 3 grooves



139106

Replacing 855 610 01
Servicing 633 212 34, -80, 633 216 02, -26, -63
O.D. 60 mm, Bore 17 mm, W. 39.1 mm, 4 grooves



139314

Replacing 855 619 11
Servicing A127im: 633 213 21, 633 413 21
O.D. 48.5 mm, Bore 17 mm, W. 37.2 mm, 7 grooves



138463

Replacing 855 614 41
Servicing AA125R: 633 213 98
O.D. 62.4 mm, Bore 17 mm, W. 37.3 mm, 6 grooves



139109

Replacing 855 618 71
Servicing 633 213 33, -52, 633 413 33, -52
O.D. 54.8 mm, Bore 17 mm, W. 42.3 mm, 6 grooves



139316

Replacing 855 620 91
Servicing A127i: 633 216 71, 633 416 71
O.D. 56.2 mm, Bore 17 mm, W. 27.4 mm, 5 grooves



138786

Replacing 855 618 81
Servicing 633 203 09, 633 213 51, 633 413 51
O.D. 54.8 mm, Bore 17 mm, W. 37.7 mm, 5 grooves



139135

Replacing 836 098 60
Servicing 633 212 35, -81, 633 216 03, -04
O.D. 60.1 mm, Bore 17 mm, W. 20.4 mm, 4 grooves



139317

Replacing 855 612 51
Servicing A115i: 633 212 77, 633 216 10
O.D. 61.9 mm, Bore 17 mm, W. 26.8 mm, 4 grooves

Replacing MAGNETI MARELLI

Also see Pulley Survey page 809



139412

Replacing 855 612 11
Servicing 633 212 78, -87, 633 213 11, -12, -30, 633 216 11, -12, -13, -40
 O.D. 61.9 mm, Bore 17 mm, W. 36.9 mm, 6 grooves



230313

Replacing 9948225, F-230866
Servicing Fiat
 O.D. 61.5 mm, Bore 17 mm, W. 37.9 mm, 6 grooves, w/ Free wheel
Pulley tool: Cargo 210843



231632

Servicing 633 212 43, 633 412 43
 O.D. 67.1 mm, Bore 17 mm, W. 36.6 mm, 7 grooves



139863

Replacing 855 622 58
Servicing 633 212 44, -57, 633 214 25, 633 216 66, -69, -91, -95, 633 217 24, 633 412 44, 633 416 66
 O.D. 60.1 mm, Bore 17 mm, W. 25.6 mm, 5 grooves



231301

Replacing 855 613 01
Servicing A127i: 633 212 32, 633 213 10, -13, -16, -55, 633 214 18, -19, -23, -36
 O.D. 62.1 mm, Bore 17 mm, W. 38.5 mm, 6 grooves



231798

Replacing 836174 60
Servicing 633 216 58, 633 217 02
 O.D. 58.1 mm, Bore 17 mm, W. 25.5 mm, 4 grooves



230142

Replacing 855 622 01
Servicing A115i: 633 212 38, -39, 633 412 38, -39
 O.D. 47.6 mm, Bore 17 mm, W. 24.5 mm, 5 grooves



231398

Servicing 633 216 78, -79, 633 416 79
 O.D. 48.9 mm, Bore 17 mm, W. 30.3 mm, 6 grooves



232336

Servicing 633 212 46, 633 213 49
 O.D. 61.4 mm, Bore 17 mm, W. 39.2 mm, 7 grooves



230290

Replacing 855 610 71
Servicing A115i: 633 212 82, 633 213 67, 633 216 15, -18
 O.D. 62.5 mm, Bore 17 mm, W. 29.2 mm, 6 grooves



231511

Replacing 855 613 81
Servicing 633 213 15
 O.D. 61.9 mm, Bore 17 mm, W. 52.3 mm, 6 grooves
 Rubber clutch pulley
Pulley tool: Cargo 210873



232337

Servicing 633 212 31
 O.D. 66.3 mm, Bore 17 mm, W. 37.3 mm, 5 grooves

Also see Pulley Survey
page 809

Replacing MAGNETI MARELLI



232339

Replacing 855 615 41
Servicing 633 213 48, 633 217 05
O.D. 66.5 mm, Bore 17 mm, W. 31.5 mm,
6 grooves



234843

Servicing A115im: 633 217 29, 633 218 36
O.D. 49.4 mm, Bore 17 mm, W. 37.1 mm,
6 grooves



236118

Servicing 633 217 58
O.D. 58.6 mm, Bore 17 mm, W. 30.3 mm,
6 grooves



232340

Replacing 855 615 51
Servicing 633 213 56, 633 217 04
O.D. 60.2 mm, Bore 17 mm, W. 22.7 mm,
4 grooves

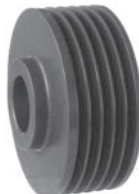

235038

Servicing A115im: 633 217 40
O.D. 56 mm, Bore 17 mm, W. 26.5 mm,
5 grooves



236120

Servicing 633 200 22, 633 210 39
O.D. 89.2 mm, Bore 17 mm, W. 15.2 mm
Single



234625

Replacing 855 611 51
Servicing A127i: 633 202 77, 633 212 53,
633 213 28, -40
O.D. 59.5 mm, Bore 17 mm, W. 42.8 mm,
5 grooves



235162

Servicing A115im: 633 217 33, -34
O.D. 54 mm, Bore 17 mm, W. 30 mm,
6 grooves



236724

Servicing A115im: 633 217 63
O.D. 60 mm, Bore 17 mm, W. 25.7 mm,
4 grooves

234627

Replacing 855 627 41
Servicing 633 217 75, 633 217 18
O.D. 53.62 mm, Bore 17 mm, W. 27.6 mm,
5 grooves



236085

Servicing AA125r: 633 200 40, 633 201 11,
-22,
633 211 36
O.D. 58.61 mm, Bore 17 mm, W. XX mm,
4 grooves

Replacing MAGNETI MARELLI



210873

Tool to be used for mounting and dismounting of Magneti Marelli rubber clutch pulley



210843

Tool to be used for mounting and dismounting of free wheel pulleys
Shaft L. 74 mm.

210948

As Cargo 210843, but
Shaft L. 114 mm.

Fan & Pulley Parts



235330 Std pkg 200

Servicing AA125R: 633 200 01, -03, -05, -06, -07, 633 210 15, -28, -71, -80, -81, -633 211 03, -12, -20, -70, 633 214 09, -93, 633 955 75
60 x 17 x 2.5 mm
Washer

Sundry Parts



132323 Std pkg 10

Replacing 12058880, 749 903 90
Servicing 633 036 . . , 633 037 . . , 633 040 . .
Connection



134794 Std pkg 10

Servicing 540 224 59, -98, 633 213 58
Inside M5, Outside M5, L. 27.5 mm
Adaptor



134800

Servicing AA108: 633 005 15, 633 009 05
Adaptor



139216

Servicing 540 224 59, -98, 633 213 58
Inside M6, Outside M5, L. 34.5 mm
Adaptor

Replacing MAGNETI MARELLI

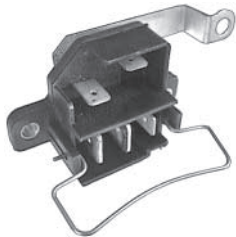

135881 Std pkg 5
Servicing 633 210 59
 Terminal block
Terminal lock: Cargo 139963



139963 Std pkg 10
 Terminal lock for Cargo 135881, 136880



231431 Std pkg 5
Servicing A115i: 633 213 48,
 633 217 05, 633 417 05
 B+, D+ terminal



136880
Servicing 633 211 05
 Terminal block
Terminal lock: Cargo 139963



234962 
Servicing A115i: 633 203 09, 633 212 27,
 -53, 633 213 24, -58, 633 214 22,
 633 400 04, 633 413 58
 O.D. 39.52 mm
 Terminal cap



232465
Servicing 633 216 79
 B+ terminal



234331
Servicing 633 217 33, -34, -41
 Terminal block



139353
Servicing A127: 540 221 60
 Heat shield



134730 Std pkg 10 
Servicing AA125: 633 022 07,
 633 052 06, -36, 633 072 06
 Insulator B+ terminal



233825
Servicing 633 217 11, 633 417 11
 Terminal



231353
Servicing A127: 633 212 43, 633 412 43
 Resistor



138142 Std pkg 10
Servicing A127i
 Insulator for stator leads

Replacing MAGNETI MARELLI



233339 Std pkg 10
Servicing A115i, A127i
 Round hole
 Insulator



234422
Servicing 633 203 09, -17
 633 212 27, -32, -37, -46, -53,
 633 213 10, -13, -24, -31, -40, -45, -46,
 -47, -49, -58, -89, -95, -98, 633 214 18
 M6/M7 x 91.5 mm
 Thru bolt



233860
Servicing 633 203 17, 633 212 31,
 633 214 21, -34, 633 414 34
 M4 x 17 mm
 Screw



134727 Std pkg 10 **A**
 5 x 21.5 mm
 Rivet



232056 Std pkg 5
Servicing A115i
 O.D. 30 mm, I.D. 17 mm, Th. 2.3 mm
 Shaft washer

235314 
Servicing A127i: 633 212 31, -32, -41, -45,
 -53, 633 214 12
 L. 8 mm
 M5
 Nut



139105 Std pkg 10
Replacing 855 609 91
Servicing A115i: 633 213 12, 633 216 13
 M5 x 42 mm
 Thru bolt



232062 Std pkg 5
Servicing A115i
 O.D. 13.5 mm, I.D. 9.5 mm, W. 5 mm
 Spacer for B+ stud



232055 Std pkg 10
Servicing A115i
 M4 / M5 x 56 mm
 Thru bolt



234833 
Servicing A115i: 633 203 09, 633 212 39,
 -44, 633 213 45, -46, -47,
 633 216 36, -69, -91, -95, 633 217 11, -24,
 -30, -39, -58, -78, 633 218 36, 633 412 39
 O.D. 13 mm, I.D. 9.3 mm, W. 8.5 mm
 Spacer

Replacing MAGNETI MARELLI

Generator Regulators

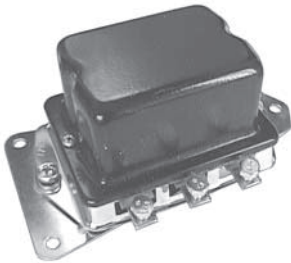

130035

Replacing GPI-24/7, 4129109
24 V. 7 Amp. 200 Watt

Generator Brush Sets



JX16 2 Std pkg 10
Replacing 4050304
7 x 19 x 26 mm
12 V.



JX22 2 Std pkg 10
Replacing 4110852
6 x 16.5 x 20.5 mm
12 V.



JX26 2 Std pkg 10
Replacing 4136135
6 x 16.5 x 20.5 mm
12 V.

Replacing MAGNETON

Rotors



136091

Replacing 443 930 135 140, 0135141
Servicing 443 113 516 610, -611, -614, -630, -631, -632, -660, -661, -662, -690, -700, -701, -711, -714, -720, -721, -730
 12 V. 55/65/70 Amp.
 L. 145 mm, O.D. 88 mm, Shaft 17 mm



231722

Replacing 443 930 136 051, 0136051
Servicing 443 113 516 590, -591, -592, -593, 9516 590, -591
 12 V. 90 Amp.
 L. 161.5 mm, O.D. 93.5 mm, Shaft 17 mm



234586

Replacing 0138211
Servicing 9515 170, -241, -461, -471, -501, -511, -521, -530, -765
 12 V. 55/65/70 Amp.
 L. 155.7 mm, O.D. 88.3 mm, Shaft 17 mm



137354

Replacing 443 930 133 211, 0133211
Servicing 443 113 516 650, -653
 12 V. 55 Amp.
 L. 151 mm, O.D. 88 mm, Shaft 20 mm



234442

Replacing 0138271
Servicing 9517 003, -062, -074, -102, -103, -161, -162, -163, -164, -166, -168, -169, -241, -403, -463, -464
 12 V. 70 Amp.
 L. 153.6 mm, O.D. 93.1 mm, Shaft 17 mm

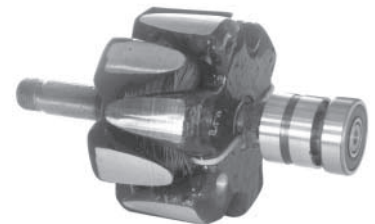

234587

Replacing 0138721
Servicing 9515 120, -122, -124, -125
 12 V. 120 Amp.
 L. 165.2 mm, O.D. 93.4 mm, Shaft 17 mm



137355

Replacing 443 930 134 761, 0134761
Servicing 443 113 516 830, -831, -832, -833, -836, -840, -842, -846, -848, -850, -851, -852, -856, -860, -862, -866, -870
 24 V. 35 Amp.
 L. 150 mm, O.D. 88 mm, Shaft 20 mm

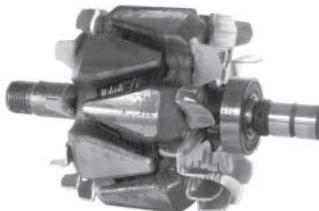

234443

Replacing 0137581
Servicing 9517 033, -082, -083, -092, -094, -181, -182, -183, -184, -185, -186, -187, -188, -189, -212, -213, -218, -219
 12 V. 90 Amp.
 L. 152.7 mm, O.D. 93.3 mm, Shaft 17 mm

Replacing MAGNETON

Stators



133415

Replacing 443 930 134 351, 0133791
Servicing 443 113 516 630
 12 V. 55 Amp.
 O.D. 127.7 mm, I.D. 88.6 mm, W. 20.2 mm



231862

Replacing 443 930 136 101
Servicing 443 113 516 591
 12 V. 90 Amp.
 O.D. 124.9 mm, I.D. 93.5 mm, W. 31 mm



234928

Replacing 0137341 
Servicing 9517 003, -062, -074, -102, -103, -161, -162, -163, -164, -166, -168, -169, -241, -403, -463, -464
 12 V. 70 Amp.
 O.D. 124.7 mm, I.D. 93.6 mm, W. 32.2 mm



137356

Replacing 443 930 133 831, 0133831
Servicing 443 113 516 830, -831, -832, -833, -836, -840, -842, -846, -848
 24 V. 35 Amp.
 O.D. 128.2 mm, I.D. 88.4 mm, W. 24.4 mm



234589

Replacing 0136071
Servicing 9515 080, -081, -241, -461, -471, -491, -501, -511, -583, -652, -765, 9516 760, -761, -762, -763
 12 V. 55 Amp.
 O.D. 128 mm, I.D. 88.8 mm, W. 20.2 mm



234929

Replacing 0137501 
Servicing 9517 033, -082, -083, -092, -094, -181, -182, -183, -184, -185, -186, -187, -188, -189, -212, -213, -218, -219
 12 V. 90 Amp.
 O.D. 124.9 mm, I.D. 93.3 mm, W. 32.1 mm



230084

Replacing 443 930 135 001, 0135000
Servicing 443 113 516 660, -661, -662, -668, -670, -673, -730, -731, -733, -734, -738, -740, -743, -744, -748
 12 V. 70 Amp.
 O.D. 128 mm, I.D. 88.3 mm, W. 20.1 mm



234595

Replacing 0138751
Servicing 9515 120, -122, -124, -125
 12 V. 120 Amp.
 O.D. 124.6 mm, I.D. 93.3 mm, W. 35.9 mm

Replacing MAGNETON

Brackets D.E.



136093

Replacing 443 930 133 010, 0135211
Servicing 443 113 516 630, -631, -632, -660, -661, -662, -750, -751, -752
 W/ bearing



137358

Replacing 443 930 133 221, 0133221
Servicing 443 113 516 650, -633, -830, -831, -832, -833, -836, -850, -851, -852, -856
 W/ bearing



231724

Replacing 0135891
Servicing 443 113 516 590, -591, -592, -593, 9516 590, -591, -592, -593
 W/ bearing

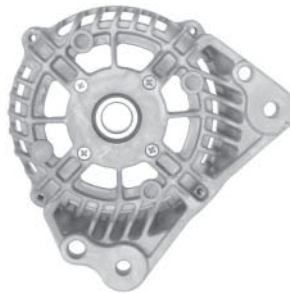

234599

Replacing 0136950
Servicing 9517 003, -033, -062, -074, -082, -083, -092, -094, -102, -103, -108, -161, -162, -163, -164, -168, -169, -181, -182, -183, -184, -185, -186, -187, -188
 W/ bearing

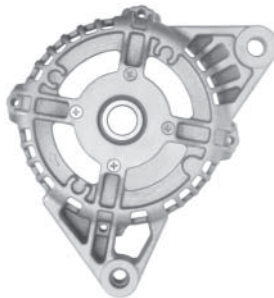

234600

Replacing 0137110
Servicing 9517 241
 W/ bearing



234601

Replacing 0137890
Servicing 9515 120, -122, -124, -125
 W/ bearing

Brackets S.R.E.



136083

Replacing 443 930 133 720, 0133721
Servicing 443 113 516 630, -631, -632, -650, -653, -750, -751, -752, -830, -831, -850, -852
 Complete w/ rectifier



231725

Replacing 443 930 135 971, 0135971
Servicing 443 113 516 590, -591, -592, -593, 9516 590, -591
 Complete w/ rectifier
 Bearing: Cargo 140081



234588

Replacing 0138231
Servicing 9515 230, -241, -765

Replacing MAGNETON



234696

Replacing 0137121
Servicing 9517 241
Bearing: Cargo 140273

Covers



234597

Replacing 321060881
Servicing 9517 003, -033, -102, -103, -108, -212, -213, -218, -219, -241, -264, -403, -413

Regulators



131284

Replacing 443 116 417 02
Servicing Skoda
 12 V.
 Electronic



234598

Replacing 321060875
Servicing 9517 062, -074, -082, -083, -092, -094, -161, -162, -163, -164, -166, -168, -169, -181, -182, -183, -184, -185, -186, -187, -188, -189, -463, -464, -482, -483, -484



131285

Replacing 443 116 419 071
Servicing Skoda
 12 V.
 Electronic



133417

Replacing 443 930 134 291, 0136131
Servicing 443 113 516 630, -631, -632, -650, -653
 12 V.

Replacing MAGNETON



137357

Replacing 443 930 134 731, 0134731
Servicing 443 113 516 830, -831, -832, -833, -836, -850, -851, -852, -856
 24 V.



234480

Replacing 0138841
Servicing 9515 120, -122, -124, -125
 12 V.



234592

Replacing 0138951
Servicing 9517 003, -033, -102, -103, -108, -212, -213, -218, -219, -241, -403, -413
 12 V.
 W/ brush holder



233731

Replacing 0136561
Servicing 9516 650, -653, -673
 12 V.



234590

Replacing 0136960
Servicing 9517 003, -033, -102, -103, -108, -212, -213, -218, -219, -241, -403, -413
 12 V.



234593

Replacing 0139381
Servicing 9517 062, -074, -082, -083, -092, -094, -161, -162, -163, -164, -166, -168, -169, -181, -182, -183, -184, -185
 12 V.
 W/ brush holder



233741

Replacing 0138021
Servicing 9516 711, -714
 12 V.



234591

Replacing 0137770
Servicing 9517 062, -074, -082, -083, -092, -094, -161, -162, -163, -164, -166, -168, -169, -181, -182, -183, -184, -185, -186, -187, -188, -189, -463, -464, -482
 12 V.



234912

Replacing 0136111
Servicing 9515 110, -112, -114, -115, -131, 9516 380, -381, -590, -591
 12 V.



Replacing MAGNETON

Regulator Parts



235316 Std pkg 500
 Servicing 443 113 516 591
 Plate



Rectifiers



133418
 Replacing 443 930 133 701, 0133700
 Servicing 443 113 516 181, -184, -630,
 -631, -632
 W/ diode trio



230085
 Replacing 443 930 134 990, 0134990
 Servicing 443 113 516 721, -730, -731,
 -733, -734, -738, -740, -741, -743, -744, -748



133824
 Replacing 443 930 131 450
 Servicing 433 113 516 110, -113



231721
 Replacing 443 930 135 940, 0135940, -941
 Servicing 443 113 516 590, -591, -592,
 -593, 9516 590, -591
 B+ terminal M6
 W terminal M5
 8 diodes, w/ diode trio



134977
 Replacing 443 930 135 240, 0135240
 Servicing 443 113 516 620, -650, -653,
 -711, -714, -751, -752, -761, -762, -764,
 -765



234444
 Replacing 0136260, -261, 0140870, -871
 Servicing 9515 410, -411, -414, -415,
 9616 411, -414
 B+ terminal M6 x 14 mm

Replacing MAGNETON

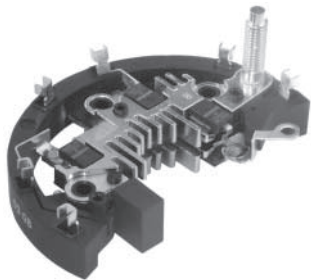

234446

Replacing 0137137
Servicing 9517 003, -062, -074, -102, -103, -161, -162, -163, -164, -166, -168, -169, -241, -403, -463, -464
 70 Amp.
 B+ terminal M8 x 28 mm

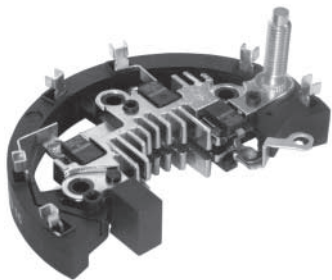

234447

Replacing 0137597
Servicing 9517 033, -082, -083, -092, -094, -181, -182, -183, -184, -185, -186, -187, -188, -189, -212, -213, -218, -219
 90 Amp.
 B+ terminal M8 x 28 mm



234596

Replacing 0138801
Servicing 9515 120, -122, -124, -125

Slip Rings



133401 Std pkg 10 **A**
 O.D. 32 mm. Shaft 17 mm, L. 22.3 mm
 W/ 1.8 mm copper

Brush Boxes



234448
Replacing 0136970
Servicing 9517 ...
 12 V. Complete w/ brushes

Also see Pulley Survey
page 909

Replacing MAGNETON

Brush Sets



PLX10 2 Std pkg 10
Replacing 443 930 132 780
 6.1 x 6.1 x 14 mm
 12 V.

Fan & Pulleys



133816
Replacing 443 935 225 850, 5233530
Servicing 443 113 516 351, -352
 O.D. 140 mm, Bore 20 mm



230293 A
Replacing 0138600, -601, F-227628.6
Servicing 9517 033, -403, -463, -483
 Audi, Seat, Skoda, VW
 O.D. 56.1 mm, Bore 17 mm, W. 41.6 mm,
 6 grooves, w/ Free wheel
Pulley tool: Cargo 210843



133875
Replacing 443 935 226 780, 5233450
Servicing 443 113 516 181, -184, -630,
 -631, -632, -731
 O.D. 135 mm, Bore 17 mm



230309
Replacing 0138620, F-230147.2
Servicing 9517 484
 Audi, Seat, VW
 O.D. 56 mm, Bore 17 mm, W. 36.9 mm,
 5 grooves, w/ Free wheel
Pulley tool: Cargo 210843



133815
Replacing 443 933 870 200
Servicing 443 113 516 351
 O.D. 92.7 mm, Bore 20 mm
 Single, B-type belt 12.5 mm



231723
Replacing 443 936 955 170, 6955170, -171
Servicing 443 113 516 591, 9516 591
 O.D. 49.6 mm, Bore 17 mm, W. 29.8 mm,
 6 grooves



136092
Replacing 443 936 954 970, 6954971
Servicing 443 113 516 661, -742, -751
 O.D. 50 mm, Bore 17 mm, W. 22 mm,
 4 grooves



234697
Replacing 6955921
Servicing 9517 241
 O.D. 50.2 mm, Bore 17 mm, W. 27.1 mm,
 5 grooves

Replacing MAGNETON



210843

Tool to be used for mounting and dismounting of free wheel pulleys
Shaft L. 74 mm.

210948

As Cargo 210843, but
Shaft L. 114 mm.

Fan & Pulley Parts



234951

Servicing 443 113 516 591, -660, -661, -662, -751
17 x 27 x 7 mm
Spacer

Sundry Parts



234728

Servicing 443 113 516 591
O.D. 13.3 mm, I.D. 5.4 mm, W. 17.2 mm
Insulator



235018

O.D. 21 mm, I.D. 6.1 mm, W. 6 mm
Insulator



235296

Servicing 443 113 516 660, -661, -662, 9516 661
Bundle clip



Replacing MANDO MELROE

Rotors

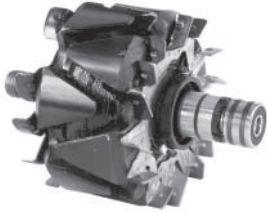

135849

Replacing 37340-24010, -32120
Servicing 37300-24500, -24510, -32130,
12 V. 40/75 Amp.
L. 141 mm, O.D. 99.4 mm, Shaft 15 mm
Shaft: Cargo 137570

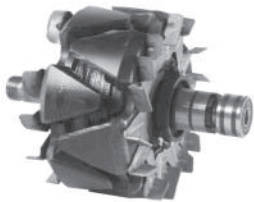

136611

Replacing 37340-33010
Servicing 37300-33000, -33010,
12 V. 75/90 Amp.
L. 141 mm, O.D. 105.3 mm, Shaft 15 mm
Shaft: Cargo 137570



231513

Servicing 37300-22200, AB190058
12 V. 90 Amp.
L. 140 mm, O.D. 99.5 mm, Shaft 15 mm

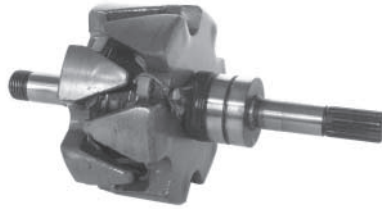

234290

Servicing AD165202, -320, -321,
APR165AA
12 V. 65 Amp.
L. 198 mm, O.D. 93 mm, Shaft 17 mm,
19 splines

Rotor Parts



137570

Servicing 37340-24010, -32120, -33010,
Cargo 135849, 136611
L. 141 mm, Shaft 15 mm



230101

L. 198 mm, Shaft 17 mm, 19 splines

Replacing MANDO MELROE

Stators



132480

Servicing AR 160A
12 V. 65 Amp.
O.D. 111 mm, I.D. 90 mm, W. 20 mm



135952

Replacing 37350-32120
Servicing 37300-32130
12 V. 75 Amp.
O.D. 125.9 mm, I.D. 100 mm, W. 20.2 mm
Internal fan



234823

Servicing AB195126, -141 
12 V. 90 Amp.
O.D. 133 mm, I.D. 106 mm, W. 20.5 mm



132934

Replacing 37350-24010
Servicing 37300-24010, -24500, -24510,
12 V. 50/70 Amp.
O.D. 124.8 mm, I.D. 99.7 mm, W. 20.1 mm



230766

Servicing 37300-35010, AB190012
12 V. 90 Amp.
O.D. 132 mm, I.D. 106 mm, W. 20 mm



234824

Servicing AB170094 
12 V. 70 Amp.
O.D. 126 mm, I.D. 100 mm, W. 20.1 mm



133963

Replacing 37350-33010
Servicing 37300-33000, -33010,
12 V. 70 Amp.
O.D. 132.9 mm, I.D. 106.2 mm, W. 20.3 mm



231512

Servicing 37300-22200, AB190058
12 V. 90 Amp.
O.D. 129.5 mm, I.D. 100 mm, W. 20.3 mm

Replacing MANDO MELROE

Brackets D.E.



135566
Servicing AR 150AA, -BA, -CC



138491
Replacing 37330-32120
Servicing AB175052, 37300-32130
Bearing: Cargo 140093



234567
Servicing AB190058
Bearing: Cargo 140093
Bearing retainer: Cargo 233912



136571
Replacing 27330-24010
Servicing 27300-24500, -24510
Bearing: Cargo 140091



138493
Servicing AB175020, 37300-33000,
 -33010
Bearing: Cargo 140420

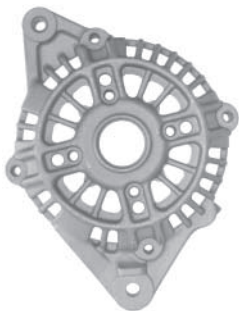

138488
Servicing AB175054



233784
Servicing AF111364, 37300-42354,
 -42355, -42356
Bearing: Cargo 140754

Replacing MANDO MELROE

Brackets S.R.E.

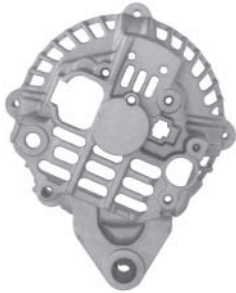

138489

Servicing AB175054



232424

Servicing AB175020



234173

Servicing AB175020, AB190025,
AB190072, 37300-33013
Bearing: Cargo 140419



138490

Servicing AB175052



233520

Servicing AD165320
W/ oil seal
Bearing: Cargo 140084



234561

Servicing AB190058
Bearing: Cargo 140432



138492

Servicing AB175053



233783

Servicing AD111364, 37300-42356
W/ oil seal
Bearing: Cargo 141012

Replacing MANDO MELROE

Bracket Parts



233912

Servicing AB170094, AB180128,
AB190025
I.D. 29 mm
Bearing retainer

Covers

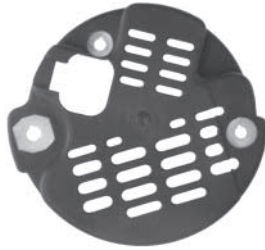

232605

Servicing AB190058

Regulators



131523

Replacing 37370-21320
Servicing 37300-24510, -32130, -33010
12 V.
Terminals S-L
Repair circuit: Cargo 133244

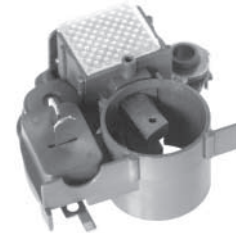

235177

Servicing AB170035, -36, AB180140,
AB190110, -111, APR140AB



131524

Replacing 37370-21320
Servicing AR 160A, AB165014, HAB
165100, 37300-24010, -24500, -32130
12 V.
Terminals R-L
Repair circuit: Cargo 133243



133320

Replacing 3 ER 1071, 42785
Servicing AR 150AA, -AC
Marine
12 V.

Replacing MANDO MELROE



133321

Replacing 12449, 42786
Servicing AR 150BA, -CA, Bobcat
 Same as Cargo 133320
 but with special plug
 12 V.



136742

Replacing A500C0111
Servicing AC155515, -603, -643,
 AC165617
 Bobcat, Mercruiser, Tennant
 12 V.

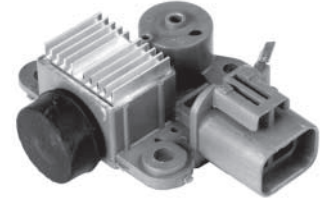

231425

Servicing AB170094
 12 V.
 Terminal S - L

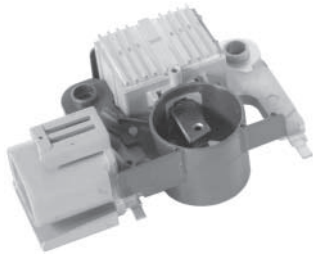

134088

Servicing AB170035, Kia
 12 V.
 Terminals S-L



138204

Replacing TA500C02401
Servicing AB190058, 37300-22200,
 12 V.

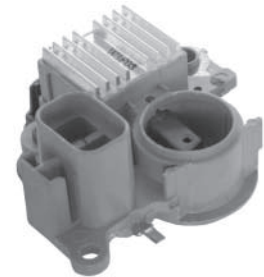

234229

Servicing AB175020, AB190025, -072
 12 V.



136731

Servicing AB111057
 12 V.
 Terminals S-L
Repair circuit: Cargo 232607



139669

Servicing 37300-42114, -42203, -42204,
 -42804, AD 165202, -165320, -165321,
 12 V.
 Terminals S-L



234252

Servicing AB180092, OK29T-18-300
 12 V.
 Terminal L -S

Volt setting 14.5 V.

Replacing MANDO MELROE



234286
 Servicing AB160108
 12 V.

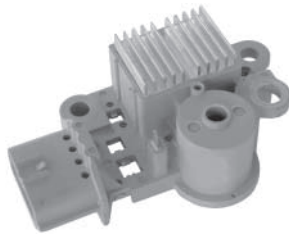

235206 
 Servicing AB112112, -145, 37300-39010, -
 39600
 12 V.

Regulator Parts

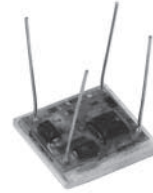

133243 
 Servicing Cargo 131524
 12 V.
 4 pin repair circuit w/ terminals R-L



234326
 Servicing AF111364, AF175363
 12 V.



133244 
 Servicing Cargo 131523
 12 V.
 4 pin repair circuit w/ terminals S-L



235205 
 Servicing AB165104, 96314258
 12 V.

Replacing MANDO MELROE

Rectifiers



136443

Servicing AR150-AA, -BA, -CA, -CC
O.D. 110 mm
B+ terminal 1/4"-20
W/ diode trio



136738

Servicing AC155515, -603, AC165610
Bobcat, Mercruiser, Tennant
O.D. 108 mm
B+ terminal 1/4"-20 x 13 mm
W/ diode trio



233484

Replacing 31620A78B00000
Daewoo
O.D. 88 mm
W/ diode trio



⊕ _____ 65 mm _____ ⊕

132791

Servicing AB 155001, AR 160A
W/ diode trio and capacitor

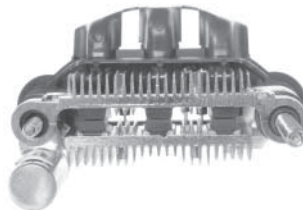

⊕ _____ 75 mm _____ ⊕

132469

Servicing AB 175015, -175019,
37300-24510, -24500
W/ diode trio and capacitor



⊕ _____ 75 mm _____ ⊕

139763

Servicing 37300-42114, -42203, -42204,
-42804, AD165202, -320, -321

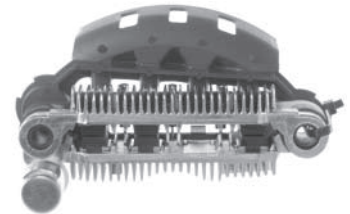

⊕ _____ 85 mm _____ ⊕

134297

Replacing 37367-32120
Servicing 37300-32130
W/ diode trio and capacitor

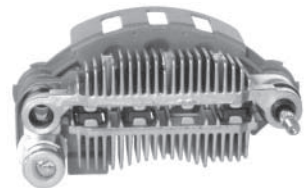

⊕ _____ 85 mm _____ ⊕

233483

Servicing AB170066, OK24-18-300A
B+ terminal M5 x 19 mm
W/ diode trio



⊕ _____ 90 mm _____ ⊕

138205

Replacing TA600C04602
Servicing AB190058, 37300-22200
12 V. 90 Amp.
B+ terminal M6 x 22.5 mm
W/ diode trio and capacitor

Replacing MANDO MELROE

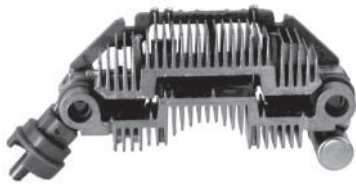

231426

Servicing AB170094
B+ terminal M6
W/ diode trio



135252

Servicing AF175207, -175362, -175385,
-190216, 37300-42542, -42872, -47500,
-47501
8 diodes
W/ diode trio and capacitor
B+ terminal M6

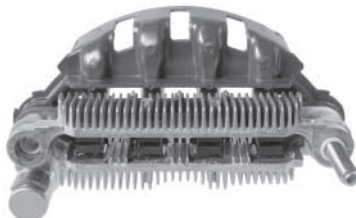

137486

Replacing A600C10301
Servicing AB111057
B+ terminal M6
W/ diode trio and capacitor

Slip Rings



133409 Std pkg 5 **A**
O.D. 23 mm, Shaft 12.5 mm, L. 28 mm



135298 Std pkg 5
O.D. 24 mm, Shaft 7.9 mm, L. 18.5 mm



231368 Std pkg 5
Servicing AD165202, -320
O.D. 32.7 mm, Shaft 17.5 mm, L. 31.6 mm



232295
Servicing 37300-22200, AB190058
O.D. 14.2 mm, Shaft 6.7 mm, L. 47.5 mm

Brush Boxes



135194
Servicing AR 150BA
12 V. Complete with brushes

Replacing MANDO MELROE

Also see Bearing Chapter
and Pulley Survey

Brush Sets



140437 A

Replacing JMTX-35, 37368-21320
5 x 8 x 18 mm
12 V.



141192

Servicing AR150CA
4.5 x 6.3 x 13 mm
12 V.

Special Bearings



140232 Std pkg 10 A

Replacing B8-79D
Servicing I.C. alternators w/ internal fan
8/23 x 11 mm
W/ snap ring
S.R.E.

Fan & Pulleys



231424

Servicing AB150021
Fan: O.D. 139 mm, Bore 15 mm
Pulley: O.D. 74 mm, I.D. 15 mm, single



133345

Servicing AR 160A
O.D. 54.2 mm, Bore 15 mm, W. 25.5 mm,
4 grooves



134712

Replacing 37321-32120
Servicing 37300-32130
O.D. 67.8 mm, Bore 15 mm, single



136040

Servicing AB165040
O.D. 60.1 mm, Bore 15 mm, W. 21.7 mm,
4 grooves

Also see Pulley Survey
page 809

Replacing MANDO MELROE



136041

Replacing 37321-24010
Servicing 37300-24500, -24510
O.D. 64.7 mm, Bore 15 mm, W. 24.2 mm,
4 grooves



230794

Servicing 37300-42354, -42355, -42356,
AF 111364
O.D. 84 mm, Bore 17 mm, W. 32 mm
Double

238546

Servicing 37300-24511 
O.D. 65 mm, Bore 15 mm, W. 21.65 mm,
4 grooves



136941

Servicing AB160044
O.D. 59.5 mm, Bore 17 mm, W. 23.6 mm,
4 grooves



231901

Servicing AB170036, APR140AB
O.D. 55 mm, Bore 15 mm, W. 21.3 mm,
4 grooves



138482

Servicing AB175054, AR175AA,
37300-22020, -32510, -32511
O.D. 60.1 mm, Bore 15 mm, W. 19.4 mm,
4 grooves



232358

Servicing AB170094
O.D. 54.3 mm, Bore 17 mm, W. 21.2 mm,
4 grooves



138483

Servicing AB175053, 37300-24511
O.D. 65 mm, Bore 17 mm, W. 22.5 mm,
4 grooves

236220

Servicing A0002655023
O.D. 57 mm, Bore 17 mm, W. xx mm
4 grooves

Replacing MANDO MELROE

Vacuum Pumps



231340

Servicing AD165202, -320, -321, 37300-42114, -42203, -42204, -42206, -42804
New type - 8 splines

Vacuum Pump Parts

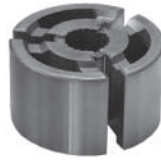

139831

Servicing AD165202, -320, -321, APR165AA
O.D. 48.5 mm, W. 27.9 mm, 16 Splines
Rotor
Vane set: Cargo 133280
Fits on vacuum pump: Cargo 231340



133280 A

4.95 x 12.6 x 27.95 mm
Rotor vane set

Sundry Parts



137843

Servicing AB190025, -028
B+ Terminal
Terminal set
B+ Insulator: Cargo 233306



231845

Servicing 37300-42114
Coupler



232428

Servicing A0B09601, AC155907, TA0B09601
Coupler

Replacing MITSUBISHI

Rotors



132477

Replacing A880T25170
Servicing A3T34391
 Mazda
 12 V. 65 Amp.
 L. 144 mm, O.D. 99.4 mm, Shaft 15 mm
Shaft: Cargo 137773

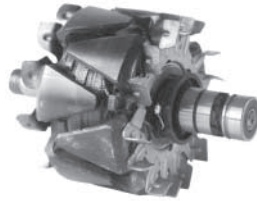

135933

Replacing A880T34370, -37270
Servicing A5T40176, -40176B, -40195, -40195B, -41094, -41094B, -41592
 12 V. 60 Amp.
 L. 141 mm, O.D. 94.5 mm, Shaft 15 mm
Shaft: Cargo 137570



136882

Replacing A880T54070, MD618181
Servicing A2T27883
 12 V. 65 Amp.
 L. 205 mm, O.D. 99.5 mm, Shaft 17 mm,
 8 splines



135648

Replacing A880T17870, -25270
Servicing A1T02871, -22971, -24471, -32471
 12 V. 40 Amp.
 L. 144 mm, O.D. 83 mm, Shaft 15 mm

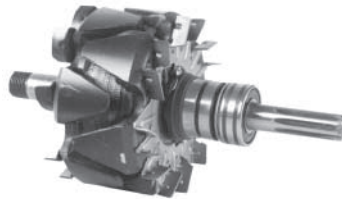

136610

Replacing A880T50470
Servicing A3T03099
 12 V. 70 Amp.
 L. 205 mm, O.D. 105.5 mm, Shaft 17 mm,
 8 splines



137415

Replacing A880T18969, -18970
Servicing A3T02972, -21277, -32872, -33272, -33977, -34077, -40472, -40672
 12 V. 70 Amp.
 L. 148 mm, O.D. 99 mm, Shaft 15 mm

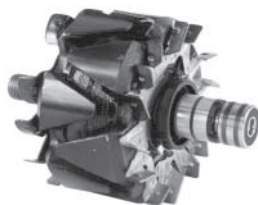

135849

Replacing A880T34070, -34470
Servicing A2T00991, -02271, -02471, -02572, -02577, -02671, -02771, -02871, -02971, -03171, -03477, -03591, -03691
 12 V. 40/75 Amp.
 L. 141 mm, O.D. 99.4 mm, Shaft 15 mm
Shaft: Cargo 137570



136611

Replacing A880T42370, -57470
Servicing A3T41876, -41892, -45693, -45694
 12 V. 75/90 Amp.
 L. 141 mm, O.D. 105.3 mm, Shaft 15 mm
 Internal fan
Shaft: Cargo 137570



137417

Replacing A880T40970
Servicing A2T01583, -01783, -10083
 12 V. 65 Amp.
 L. 198 mm, O.D. 99.5 mm, Shaft 17 mm,
 8 splines
Shaft: Cargo 230491

Replacing MITSUBISHI



137439

Replacing A880T23070, -26870
Servicing A2T14472, -41091
 12 V. 60 Amp.
 L. 144 mm, O.D. 94.5 mm, Shaft 15 mm
Shaft: Cargo 137773

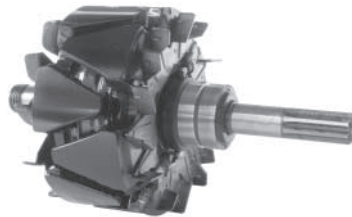

137563

Replacing A880T68070, MD618738
Servicing A3T11278, -11678
 12 V. 75/90 Amp.
 L. 188 mm, O.D. 106 mm, Shaft 17 mm,
 8 splines

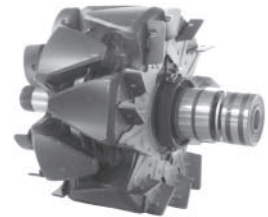

137850

Replacing A880T46970, MD611738
Servicing A4T30593
 12 V. 110 Amp.
 L. 140.8 mm, O.D. 112.5 mm, Shaft 17 mm



137444

Replacing A880T43070, -32270, -38470
Servicing A2T43372, -43372B, -44672,
 -44672B, -48594, -48594B, -48594C
 12 V. 60 Amp.
 L. 141 mm, O.D. 99.3 mm, Shaft 15 mm
Shaft: Cargo 137570

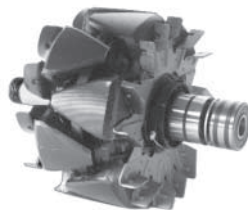

137564

Replacing A880T58770, MD618340
Servicing A4T01493
 12 V. 110 Amp.
 L. 148.6 mm, O.D. 112.5 mm, Shaft 17 mm



137851

Replacing A880T59770, -64070, -67670
Servicing A3T06791, -07592, -08491
 12 V. 90 Amp.
 L. 141 mm, O.D. 105 mm, Shaft 17 mm
Shaft: Cargo 137768



137562

Replacing A880T42670, MD611596
Servicing A3T00599, -05499
 12 V. 75 Amp.
 L. 200 mm, O.D. 105.5 mm, Shaft 17 mm,
 8 splines

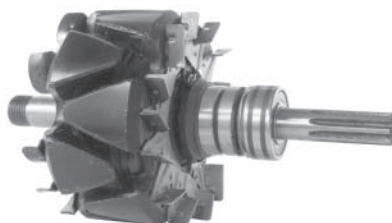

137565

Replacing A880T62270, MD611474
Servicing A3T08183
 12 V. 75 Amp.
 L. 198 mm, O.D. 105.5 mm, Shaft 17 mm,
 8 splines

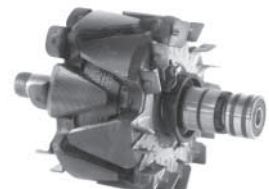

138195

Replacing A880T43370
Servicing A5T01897, -22971B, -22997B
 12 V. 50 Amp.
 L. 141 mm, O.D. 95.1 mm, Shaft 15 mm
Shaft: Cargo 137570

Replacing MITSUBISHI

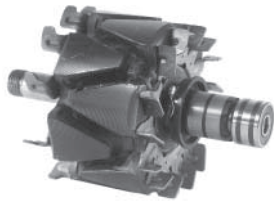

138196

Replacing A880T53670
Servicing A1T03292
 12 V. 55 Amp.
 L. 141 mm, O.D. 90 mm, Shaft 15 mm
Shaft: Cargo 137570



138400

Replacing A880T37970
Servicing A2T27477, -32277
 12 V. 50 Amp.
 L. 190 mm, O.D. 94.3 mm, Shaft 15 mm,
 8 splines

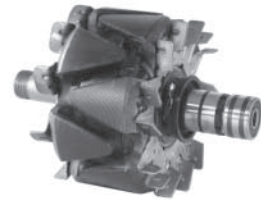

138403

Replacing A880T61870, -63670, -70270
Servicing A2TA0791, -1099, -3891, -3991,
 -6099, A2T13894, -13977X, -14592
 12 V. 75/80 Amp.
 L. 141 mm, O.D. 99.5 mm, Shaft 17 mm
Shaft: Cargo 137768

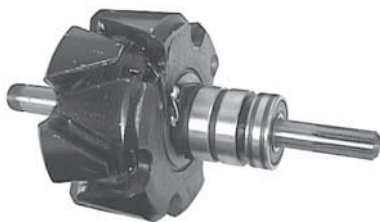

138398

Replacing A880T23370
Servicing A2T40484, -41477, -43183,
 -43583
 12 V. 55 Amp.
 L. 188 mm, O.D. 94 mm, Shaft 15 mm,
 8 splines



138401

Replacing A880T40770
Servicing A2T01384, -02084, -06384
 12 V. 50 Amp.
 L. 198 mm, O.D. 99.5 mm, Shaft 17 mm,
 8 splines
Shaft: Cargo 230491



138602

Replacing A880X71470
Servicing A2T05772X, A5T02677X,
 -3477X, -03777, -05091, -07591, -07592
 12 V. 75 Amp.
 L. 141 mm, O.D. 94.5 mm, Shaft 17 mm
Shaft: Cargo 137768



138399

Replacing A880T26470
Servicing A3T35278, -35278A, -35299A
 12 V. 60 Amp.
 L. 188 mm, O.D. 99 mm, Shaft 15 mm,
 8 splines

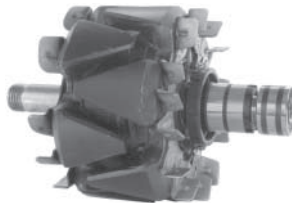

138402

Replacing A880T57170, -61770
Servicing A5T01497, -01577, -02677,
 -03477, -03479, -30871, -30977, -30977A
 12 V. 60 Amp.
 L. 141 mm, O.D. 94.5 mm, Shaft 15 mm
Shaft: Cargo 137570



138622

Replacing A880X67970
Servicing A2T37976, -38676, -82899,
 A2TN0076, -0199, -0299, -0399, -0499
 12 V. 65/75 Amp.
 L. 188 mm, O.D. 99.5 mm, Shaft 17 mm,
 8 splines

Replacing MITSUBISHI



138859

Replacing A880T37370
Servicing A2T48292, -48298
 12 V. 70 Amp.
 L. 141 mm, O.D. 99.5 mm, Shaft 17 mm
Shaft: Cargo 137768



230140

Replacing A880T21470, MD607565
Servicing A2T12671, -16371, -16871, -23477, A5T15171, -15471, -20377, -20387, -21472, AQ2240K1, -2250K, -2250K1
 12 V. 50 Amp.
 L. 144 mm, O.D. 89 mm, Shaft 15 mm

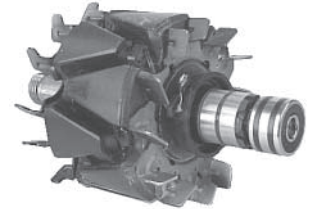

230652

Replacing A880T65370, -65470
Servicing A7T00598, -01874, -01874A, -02591, -02691, -02691A, -03091, -01474, -01491, -01771, -01771A, -02071, -02071A
 12 V. 50 Amp.
 L. 141 mm, O.D. 83.5 mm, Shaft 17 mm



230045

Replacing A880T47668, -47670, -48170
Servicing A2T04577, -04599, -05892, -05892A, -05892B, -06091, -06092, -33593, -33593A, -33593B, -33593C, -35791A
 12 V. 80 Amp.
 L. 143 mm, O.D. 98 mm, Shaft 17 mm

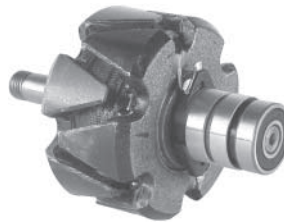

230163

Replacing A880T14370, -14469, MD607300
Servicing A2T14972, -21982, -24371, -24771, -25071, -25271, -26572, AH2250C42, -2250E2, AQ2250C31
 12 V. 55 Amp.
 L. 150 mm, O.D. 95 mm, Shaft 17 mm

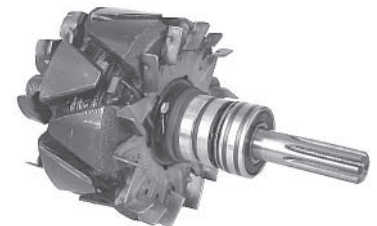

230656

Replacing A880T62070, MD618527
Servicing A3T07483
 12 V. 90 Amp.
 L. 198 mm, O.D. 105.5 mm, Shaft 17 mm, 8 splines



230137

Replacing A880T12170, -19883
Servicing A1T01171, -21377, -21971, -21972, -22074, -22871, -23377, -23874, -24771, -25077, -25083, -25477, -25483
 12 V. 40 Amp.
 L. 136 mm, O.D. 83.5 mm, Shaft 15 mm

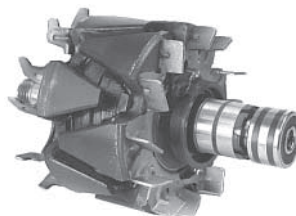

230651

Replacing A880T47170, -47194
Servicing A7T00171, -00191, -00271, -00591, -00774, -01171, -01174, -01374, -01991
 12 V. 50 Amp.
 L. 141 mm, O.D. 83.5 mm, Shaft 15 mm

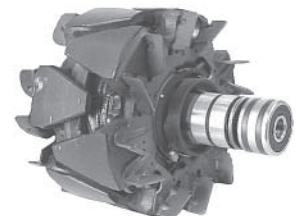

230657

Replacing A880T54670, -54770, -59170
Servicing A5T00877, -00972, -01271, -01977, -02777
 12 V. 65 Amp.
 L. 141 mm, O.D. 94.5 mm, Shaft 15 mm

Replacing MITSUBISHI

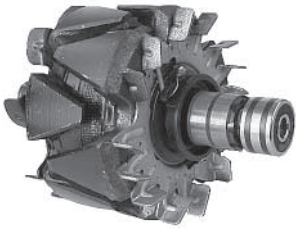

230658

Replacing A880T61370, -62470
Servicing A5T03391, -03391A, -03677, -03677A
 12 V. 60 Amp.
 L. 141 mm, O.D. 94.5 mm, Shaft 17 mm

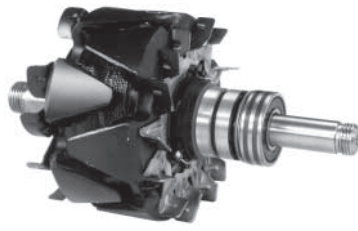

231076

Replacing A880T66870
Servicing A2T36478, A2TN0678, -0684
 12 V. 75 Amp.
 L. 180 mm, O.D. 99.4 mm, Shaft 15/17 mm

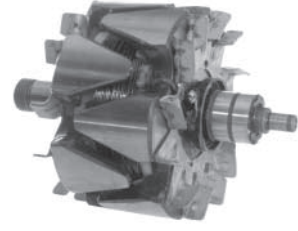

231568

Servicing A2TA2091, -2091D, -2091E, -2091F
 12 V. 90 Amp.
 L. 142.7 mm, O.D. 99.4 mm, Shaft 17 mm



230659

Replacing A880T35970, -37070
Servicing A2T41599A, -47299
 12 V. 60 Amp.
 L. 225.4 mm, O.D. 99.5 mm, Shaft 17 mm, 8 splines

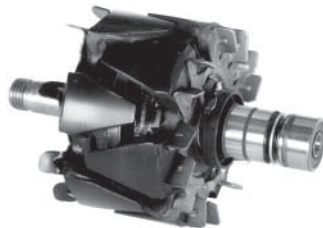

231131

Replacing A880T48770
Servicing A1T02091, -2191, -2291, -4691, -4791, -4892
 12 V. 60 Amp.
 L. 141 mm, O.D. 89.3 mm, Shaft 15 mm



233761

Servicing A3TA5591, -5591A, A3TB0891, -0891B
 12 V. 120 Amp.
 L. 148.6 mm, O.D. 105.5 mm, Shaft 17 mm

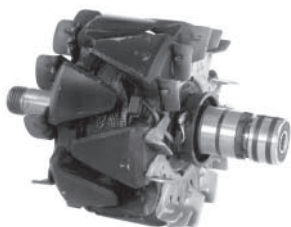

231002

Replacing A880T38770, A880X48070
Servicing A2T05772, -13471, -43671, -45091
 12 V. 60 Amp.
 L. 141 mm, O.D. 99.5 mm, Shaft 15 mm

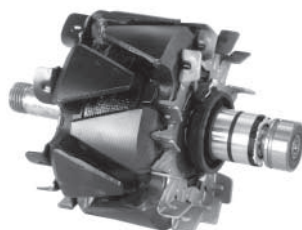

231263

Replacing A880T26670
Servicing A2T40571B, -40577B, A5T30277, -41271, -41277
 12 V. 55 Amp.
 L. 141 mm, O.D. 94 mm, Shaft 15 mm



234074

Replacing A880T24570
Servicing A5T15684, -15784, -15884, -16384, -20484, -21684, -21984, -23784
 12 V. 45 Amp.
 L. 187.5 mm, O.D. 89.5 mm, Shaft 15 mm, 8 splines

Replacing MITSUBISHI



234094

Replacing A880T15470
Servicing A1T70783, -70883, -71474, AH4020Z1
 24 V. 20 Amp.
 L. 136 mm, O.D. 83 mm, Shaft 15 mm



234132

Servicing A4T00891, -00891C, -00891D, -00891E, -01591, -02891, -03091
 12 V. 95 Amp.
 L. 141.4 mm, O.D. 112.4 mm, Shaft 17 mm

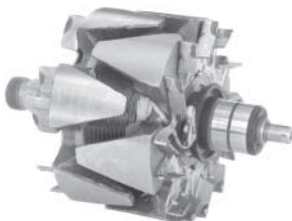

234621

Servicing A5TA2591, -4391, -6591
 12 V. 70 Amp.
 L. 142.9 mm, O.D. 94.5 mm, Shaft 17 mm

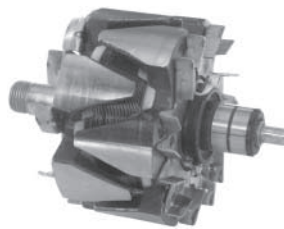

234622

Servicing A2TB6481
 12 V. 110 Amp.
 L. 143 mm, O.D. 99.5 mm, Shaft 17 mm

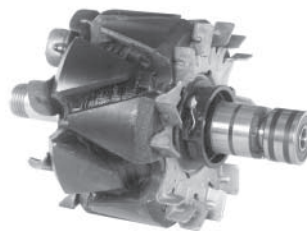

234635

Replacing A880T64270
Servicing A5T06891A
 12 V. 70 Amp.
 L. 142.4 mm, O.D. 94.5 mm, Shaft 17 mm

235389

Replacing A880X81670
Servicing A2TN1798, 1798ZT
 12 V. 80 Amp.
 L. 188 mm, O.D. 99.5 mm, Shaft 17 mm

Rotor Parts



132080 A

Servicing A529X04971
 M17-1.5
 Rotor shaft nut set



133612 Std pkg 5 A

Servicing A529X02171
 M15-1.5
 Rotor shaft nut set



137570

Servicing A880T36670, -38770, -39170, -39570, -39870, -46070, -48070,
 Cargo 137226, 138195, 138402
 L. 141 mm, Shaft 15 mm
 Rotor shaft



137768

Servicing A880T59770, -61870, -64070,
 Cargo 137851, 138403, 138602, 138859
 L. 141 mm, Shaft 17 mm
 Rotor shaft

Replacing MITSUBISHI



137771

Servicing A880T19883, AH2035H4, -H54, -T1, A1T32371
L. 136.1 mm, Shaft 15 mm
Rotor shaft



230491

Servicing A880T40770, -40970, Cargo 137417, 138401
L. 198 mm, Shaft 17 mm, 8 splines
Rotor shaft

Stators



132478

Replacing A383T15370
Servicing AQ2250G1, A2T23271, -27091
Citroen, Peugeot
12 V. 50 Amp.
O.D. 124 mm, I.D. 94.9 mm, W. 20.8 mm



137772

Servicing A2T23471, -23474, -23477, -23494, -31677, -40374, -40377, A3T20777
L. 148.7 mm, Shaft 15 mm
Rotor shaft



132480

Replacing A383T24570, -27970
Servicing A1T40391, -40891, -40791
12 V. 65 Amp.
O.D. 111 mm, I.D. 90 mm, W. 20 mm



137773

Servicing A880T23070, Cargo 132477, 137439
L. 144 mm, Shaft 15 mm
Rotor shaft



132933

Replacing A383T25570, -31270
Servicing A2T30271, A5T30574
12 V. 55/60 Amp.
O.D. 118 mm, I.D. 94.9 mm, W. 20.1 mm



230102

Servicing A880T30770
L. 199 mm, Shaft 17 mm, 8 splines
Rotor shaft

Replacing MITSUBISHI



132934

Replacing A383T27570, -29570
Servicing A2T03591, -05892, -41791, -45272, -46492, -48176
 12 V. 50/70 Amp.
 O.D. 124.8 mm, I.D. 99.7 mm, W. 20.1 mm



133760

Replacing A383T18770, MD607515
Servicing A3T34572, -34672, -34677, -35577
 12 V. 65 Amp.
 O.D. 131 mm, I.D. 100 mm, W. 21.0 mm



134048

Replacing A383T19570, -21170
Servicing A5T15684, -15884
 12 V. 45 Amp.
 O.D. 117 mm, I.D. 90 mm, W. 21.2 mm



133758

Replacing A383T23070, 23102-05E16
Servicing A3T35278
 12 V. 60 Amp.
 O.D. 131 mm, I.D. 100 mm, W. 21.3 mm



133963

Replacing A383T35870, -36670
Servicing A3T02478, -02892, -03099, -03492, -03493
 12 V. 70 Amp.
 O.D. 132.9 mm, I.D. 106.2 mm, W. 20.3 mm



134802

Servicing A3T03298, -45298, Citroen, Peugeot
 12 V. 80 Amp.
 O.D. 130.5 mm, I.D. 100 mm, W. 21.1 mm



133759

Replacing A383T19370
Servicing A3T33272, -33684
 12 V. 60 Amp.
 O.D. 131 mm, I.D. 100 mm, W. 21.0 mm



134028

Replacing A383T40070
Servicing A5T00877, -01599, -01777, -01977, -02777, -06891, -6891A, -6891T, -6991, -7391
 12 V. 65 Amp.
 O.D. 118.8 mm, I.D. 95.1 mm, W. 20.1 mm



135165

Servicing A2T26391G, -26291, -27091, Citroen, Peugeot
 12 V. 50 Amp.
 O.D. 124.1 mm, I.D. 94.8 mm, W. 20.9 mm

Replacing MITSUBISHI



135270

Replacing A383T34770
Servicing A2T08394, -13894, -14694, -18792, -27594, -29494
 12 V. 80 Amp.
 O.D. 126 mm, I.D. 100 mm, W. 20.2 mm



135952

Replacing A383T38170, MD618209
Servicing A2T09591, -13977, -17574, -18177, -18277, -18874, -19991, -29594, -33191, -33493, -33991, -34477, -35177
 12 V. 80 Amp.
 O.D. 126 mm, I.D. 100 mm, W. 20.2 mm



136664

Replacing A383T26570, ME100569
Servicing A5T70178, -70183, -70283
 24 V. 25 Amp.
 O.D. 117 mm, I.D. 90 mm, W. 21 mm



135283

Replacing A383T20470, -28870
Servicing A1T32471, -33277
 12 V. 40 Amp.
 O.D. 111 mm, I.D. 84 mm, W. 21 mm



136333

Replacing A383T34370
Servicing A7T00191, -00271, -02691, -03771
 12 V. 55 Amp.
 O.D. 108 mm, I.D. 84 mm, W. 20.2 mm



137437

Replacing A383T41770, -46570
Servicing A5T02477
 12 V. 50 Amp.
 O.D. 119 mm, I.D. 95 mm, W. 20 mm



135922

Replacing A383T12470, -12570, -19670
Servicing A1T20573, -21377, -21971, -21972, -22871, -70783, -71076, -71176, -71276, -71576, AH2035F1, -F2, -H4, -H7
 12 V. 40 Amp. 24 V. 20 Amp.
 O.D. 111 mm, I.D. 84 mm, W. 17.5 mm



136612

Replacing A383T32670, MD611562
Servicing A3T02392, -15099, -41876, -41892, A3TA0592
 12 V. 75 Amp.
 O.D. 133 mm, I.D. 106 mm, W. 20 mm



137576

Replacing A383T25070, -29970
Servicing A7T30271, -30371, -30374, -30471, -30571
 12 V. 45 Amp.
 O.D. 103.8 mm, I.D. 83 mm, W. 20.2 mm

Replacing MITSUBISHI



137716

Replacing A383T34270
Servicing A4T01493
 12 V. 110 Amp.
 O.D. 139.9 mm, I.D. 113 mm, W. 20.1 mm



139186

Replacing A383T43770, A383X46870
Servicing A3T07399, -07483, -07983, -09198, -09199, -11678, A3TN0199, -0699, -0899, -1578
 12 V. 90 Amp.
 O.D. 132.5 mm, I.D. 106 mm, W. 20.2 mm



139542

Replacing A383T42770, MD618420
Servicing A4T01893, -0391
 12 V. 90 Amp.
 O.D. 143 mm, I.D. 112.5 mm, W. 20.3 mm



138603

Replacing A383X51270
Servicing A5T07591, -07592
 12 V. 75 Amp.
 O.D. 118.5 mm, I.D. 95 mm, W. 20 mm



139187

Replacing A383T46070, MD618718
Servicing A2T38291, -39991, -39992, -80591, -80592, A2TA4391, -5291, -5391
 12 V. 90 Amp.
 O.D. 126 mm, I.D. 100 mm, W. 20.3 mm



230001

Replacing A383X47470
Servicing A7T03171, -03171A, -03371, -03371A, -03571, A7TA0777
 12 V. 35 Amp.
 O.D. 105 mm, I.D. 84 mm, W. 20 mm



138623

Replacing A383X46670
Servicing A2T34892, -35091, -37976, -82899, A2TA0991, -2871, A2TN0199, -2871, A2TN0199, -0299, -0399, -0499
 12 V. 50/65 Amp.
 O.D. 126 mm, I.D. 100 mm, W. 20 mm



139188

Replacing A383T46170
Servicing A3T11091, -11191, -14591, A3TA0491, -0791, -0791A, -1391, -1691, -3098, -3391, -4691
 12 V. 90 Amp.
 O.D. 132.80 mm, I.D. 106 mm, W. 20.1 mm



230138

Replacing A383T38370, MD619038
Servicing A1T03292, -03392, -03791, -03729, -05792, -06191, A1TA0191, -1174, -1491, -1491A
 12 V. 60 Amp.
 O.D. 112 mm, I.D. 90 mm, W. 20 mm

Replacing MITSUBISHI



230653

Replacing A383T37470
Servicing A7T01171, -01174, -01771, -01771A, -02771, -02771A, -03277, -03277A, A7TA0171, -0171B, -0876
 12 V. 40 Amp.
 O.D. 104.7 mm, I.D. 84 mm, W. 20 mm



230824

Replacing A383T25670
Servicing A2T72383
 24 V. 30 Amp.
 O.D. 124 mm, I.D. 95 mm, W. 21.1 mm



231532

Servicing A2T32692, A2TA2492
 12 V. 90 Amp.
 O.D. 126 mm, I.D. 100 mm, W. 20.2 mm



230689

Replacing A383T22470
Servicing A2T14972, -26572
 12 V. 50 Amp.
 O.D. 124 mm, I.D. 94.5 mm, W. 21.2 mm



230951

Replacing A383X53770
Servicing A3TN1791
 12 V. 100 Amp.
 O.D. 133 mm, I.D. 106 mm, W. 20 mm



232265

Servicing A4T00891, -00891C, -00891D, -00891E, -00991, -00991D, -00991E, -01591, -02891, -02891A, -02891B, -03392, -03492, A4TA0092B, -0092C
 12 V. 90 Amp.
 O.D. 142 mm, I.D. 113 mm, W. 28 mm



230766

Replacing A383T32870, -47970
Servicing A3T00692, -45594
 12 V. 90 Amp.
 O.D. 132 mm, I.D. 106 mm, W. 20 mm



231335

Servicing A2TA2091, -2091D, -2091E, -2091F, -2094, -2094B, -2094C, -2094D
 12 V. 90 Amp.
 O.D. 125.9 mm, I.D. 100 mm, W. 20.2 mm



232786

Servicing A4TA0094B
 12 V. 120 Amp.
 O.D. 139.9 mm, I.D. 113 mm, W. 20.1 mm

Replacing MITSUBISHI



233380

Replacing A383T36870
Servicing A3T76682
 24 V. 40 Amp.
 O.D. 132.5 mm, I.D. 106 mm, W. 20.2 mm



234105

Replacing A383T42570
Servicing A2T33593, -33593A, -33593B, -33593C, -33593E, -35891, -35891A, -37891, -37891A, -38091, -39791, -82191
 12 V. 90 Amp.
 O.D. 136 mm, I.D. 106 mm, W. 28 mm

Brackets D.E.



134332

Replacing A640T23170
Servicing A2T41477, -43183, -43583
 W/ bearing



233402

Servicing A2T20091, -20091ZC, -33891
 12 V. 80 Amp.
 O.D. 125.9 mm, I.D. 100 mm, W. 20.4 mm



234548

Servicing A2TB6481
 12 V. 110 Amp.
 O.D. 126 mm, I.D. 100 mm, W. 19.9 mm



135011

Servicing A2T26391, -27011
 Citroen, Peugeot
 Bearing: Cargo 140091



233773

Servicing A3TA5591, -5591A, A3TB0891, -0891B
 12 V. 120 Amp.
 O.D. 136 mm, I.D. 106 mm, W. 27 mm



234618

Replacing A383T44470
Servicing A3TN1199
 12 V. 110 Amp.
 O.D. 133 mm, I.D. 106 mm, W. 26.5 mm



136177

Replacing A640T14970, MD607263
Servicing A2T12671, -16371, -16871, AQ2240K1, -2245K1, -2250K1
 Bearing: Cargo 140091

Replacing MITSUBISHI



136178

Replacing A640T24970
Servicing A5T21471, -21472
 W/ bearing



136379

Replacing A640T24470
Servicing A3T34391
 W/ bearing



136444

Replacing A640T39270
Servicing A2T05772
 W/ bearing



136259

Replacing A640T32870
Servicing A2T46871, -47371
 W/ bearing



136393

Replacing A640T22970, -35270
Servicing A5T00272, -20871, -20977, -21871, -21897, -24971
 W/ bearing



136560

Replacing A640T43370
Servicing A2T13894
 Bearing: Cargo 140589



136368

Replacing A640T22870, -26170
Servicing A2T25479, -25979, -27176, -27376, -31977, -41091, -72576, -72676, -73176
 W/ bearing



136419

Replacing A640T36070, MD611508
Servicing A2T02271, -02572, -02577, -02971, -02977, -03171, -03177, -04277
 Bearing: Cargo 140091



136571

Replacing A640T31570, MD611227
Servicing A2T00991, -02471, -03471, -03477, -03591, -03691, -03972, -09291, -09392, -09493, -22991, -43791, -43977, -44791, -48691, -49891, -49977, -49992
 Bearing: Cargo 140091

Replacing MITSUBISHI



136576

Replacing A640T42270
Servicing A2T13977, -17574, -18177, -18277, -18874
Bearing: Cargo 140420



137081

Replacing A640T25570
Servicing A3T35278A, -35299A
W/ bearing



137134

Replacing A640T31470, MD611218
Servicing A1T01991, -40791, -40891
Bearing: Cargo 140091



136618

Replacing A640T33870, RF11-18-W25A
Servicing A2T41599, -47299
W/ bearing



137082

Replacing A640T35770, MD611473
Servicing A2T01384, -01483, -01583, -01683, -01783, -02084, -06384, -09884, -10083, -27883, -49377, -49476
W/ bearing



137435

Replacing A640T36670, MD611557
Servicing A3T41876, -41892
W/ bearing



137080

Replacing A640T24870
Servicing A1T32471
W/ bearing

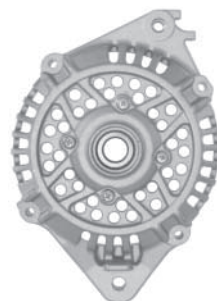

137083

Replacing A640T41070, MD611851
Servicing A3T03391, -03392, -03393, -03492, -03493, -45691, -45693
W/ bearing

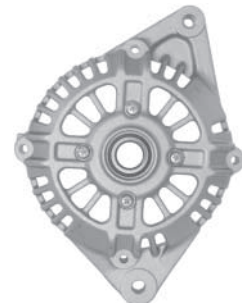

137555

Replacing A640T36870, MD611595
Servicing A3T00599, -04999, -05499, -06099, -07399, -07483, -07983, -08083, -08183
W/ bearing

Replacing MITSUBISHI



137556

Replacing A640X53170, MD618737
Servicing A3T11278, -11678
 W/ bearing



137560

Replacing A640T35970, MD611447
Servicing A2T14376, -14876, -49577
 W/ bearing



137846

Replacing A640T38870, MD611736
Servicing A4T30593
 W/ bearing



137557

Replacing A640X45570, MD618337
Servicing A4T01493, -01793, -01893
 W/ bearing

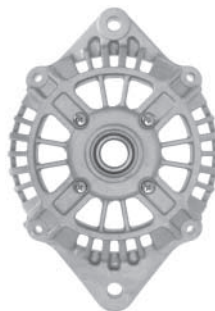

137785

Replacing A640T40770
Servicing A3T03099, A3TA2799
 W/ bearing



137847

Replacing A640T52970, MD618750
Servicing A2T80591, -81791
 W/ bearing



137558

Replacing A640T29470, MD700548
Servicing A5T22578, -22583, -70178, -70183, -70283, -70383
 W/ bearing



137845

Replacing A640T32570
Servicing A5T10377, -10477, -22877, -30977, -31277, -41477
 W/ bearing



137854

Replacing A640T20970
Servicing A1T03476, -25097, -31374, -31377, -31685, -33277, AH2040H4
 W/ bearing

Replacing MITSUBISHI

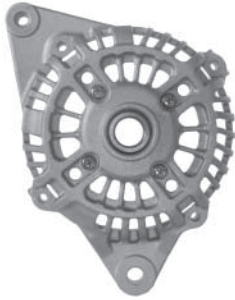

138393

Replacing A640T48770
Servicing A2T34892, -34991, -34992, -35091, -35092, -36391, -36392, -38291, -38491, -38891, -38892, -39991, -39992, -40092, A2TA0991, -3491, -5991
 W/ bearing

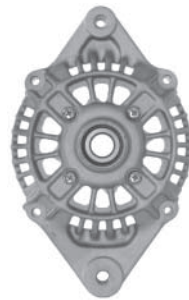

138627

Replacing A640T43270
Servicing A5T00877, -02077
 W/ bearing

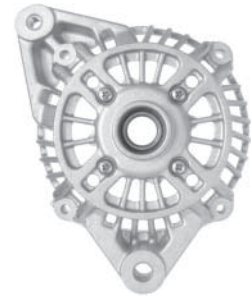

139192

Replacing A640X55470
Servicing A2T35791A, -82491, -82491A, -82491B, A2TA4091, -4091A, -4092A, A2TB0491
 W/ bearing



138604

Replacing A640T56070
Servicing A5T07491, -07591, -07592
 W/ bearing



138870

Replacing A640T48970
Servicing A2T33191, A2TA0791, -3991, -5891, A2TB0091
 W/ bearing



139543

Replacing A640T22470, MD607612
Servicing A5T15684, -15784, -15884, -16084, -20484, -20484A, -21684, -23784,
 Bearing: Cargo 140091

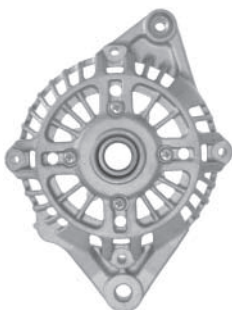

138625

Replacing A640X57770
Servicing A2T82899, A2TN0199, -0299, -0399, -0499, -0599, -1299
 W/ bearing



138911

Replacing A640T39370
Servicing A2T05892
 W/ bearing

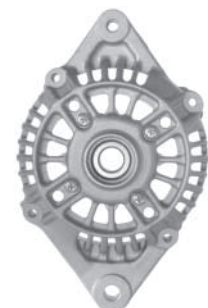

139544

Replacing A640T41870
Servicing A5T02477, -02677, -03477, -03479, Mazda
 W/ bearing

Replacing MITSUBISHI



139817

Replacing A640T50270, MD618629
Servicing A4T02991, -03091, -03191
 W/ bearing



230002

Replacing A640X54570
Servicing A7T03171, -3171A, -03371, -03371A, -03571A, -03771, -03771A, A7TA0777
 Bearing: Cargo 140093



230458

Replacing A640T47770
Servicing A2T05892A, -05892B, -05892C, -33991, -33991A
 Bearing: Cargo 140093

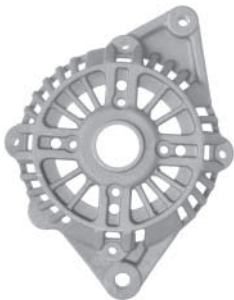

139950

Replacing A640X57870, MD618924
Servicing A3T15099, A3TN0199, -0299, -0399, -0499, -0699, -0899, -0999
 Bearing: Cargo 140093



230030

Replacing A640X55770
Servicing A5T06891, -06891A, -06891B, A5TA0591, -0591A
 W/ bearing



230597

Servicing A3T01598, Ford
 Bearing: Cargo 140411

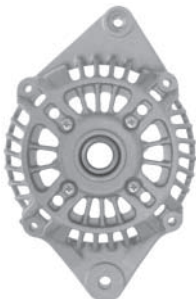

139987

Replacing A640X53070, MD618729
Servicing A2T37976, A2TN0076, -2476
 W/ bearing



230039

Replacing A640X57070, ME701341
Servicing A2TA3098, A3T08699, -08799, -09198, -09199, -09698, -09699, -09799, A3TA3098, -4298, -6098, -8199
 W/ bearing



230644

Replacing A640T24270
Servicing A2T14472, -40277, -40971, -40972
 W/ bearing

Replacing MITSUBISHI



230645

Replacing A640T20070
Servicing A2T25071, -25171
 W/ bearing



230748

Replacing A640X62370
Servicing A2TA1099, -1099A, -6099, -6099A, A2TB1298
 W/ bearing



230873

Replacing A640T34270
Servicing A2T48292, -48298
 W/ bearing



230654

Replacing A640T48670
Servicing A3T08491, -08491A, A3TA0291, -0291A
 Bearing: Cargo 140754



230767

Replacing A640T44670
Servicing A2T18476, -18479, -28976
 W/ bearing

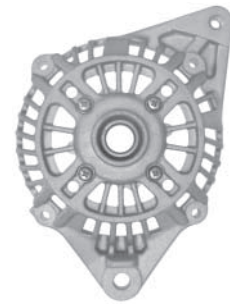

230886

Replacing A640X59670, MD619064
Servicing A2TA2691, -3091, -4391, -4991, -5191, -5192, -5192A, -5291, -5391, -5394, -5692, -5692A, A2TB0892, -3791, -5097
 W/ bearing



230672

Replacing A640T36570
Servicing A2T01077, -07677, -07777
 W/ bearing



230768

Replacing A640T51370
Servicing A2T36478, -36578, -36578A, A2TN0678, -0684
 W/ bearing



231132

Replacing A640XT54070, MD618802
Servicing A3T11591, -12991, -13091, -13191, -13191A, -13191B, -13291, -13291A, -13291B, -14491, -A0791, -A1191
 Bearing: Cargo 140754

Replacing MITSUBISHI



231221

Replacing A640T52070, MD618688
Servicing A3T11191, -11891, -11891A, -11991, -14591, -14891, A3TA0091
 W/ bearing



231834

Servicing A2T37691, -37691A
 Bearing: Cargo 140420

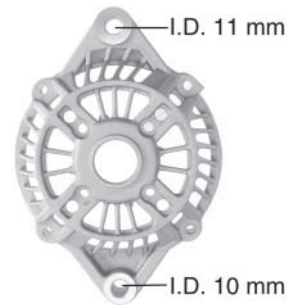

232385

Servicing A2T81192, -81292, -81391, A2TB1491
 Bearing: Cargo 140093



231338

Servicing A3TN1791
 Bearing: Cargo 140093



231940

Servicing A7T00191, -00591
 Bearing: Cargo 140420



233381

Replacing A640T51170
Servicing A2T82378
 W/ bearing



231774

Replacing A640T18170, -20570
Servicing A3T02972, -32997, -33272, -33684, -33698, -40472
 w/ bearing



232208

Servicing A2T14592
 Bearing: Cargo 140589



233505

Servicing A5TA4391, -6591
 Bearing: Cargo 140093

Replacing MITSUBISHI



233522

Servicing A5TA0991
Bearing: Cargo 140093

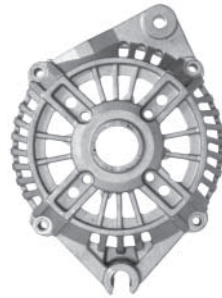

234178

Servicing A3TA0593, A4T0092B, -0092D, -0094A, -02891, -02891A, -02891B, -02893A, -02893B, -03292, -03292B, -03293, -03293A, -03392A, A4TA0092C, -0094B, -0094C, 02892, -02892A
Bearing: Cargo 140093



234562

Servicing A3TA6491, A3TB0891
Bearing: Cargo 140093



233612

Replacing A640T49970
Servicing A5T04392, -04392A, -04492B
W/ bearing



234189

Servicing A2T82091
Bearing: Cargo 140093

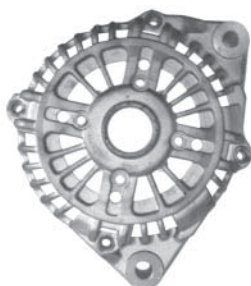

233808

Servicing A3TA5591, -5591A
Bearing: Cargo 140093

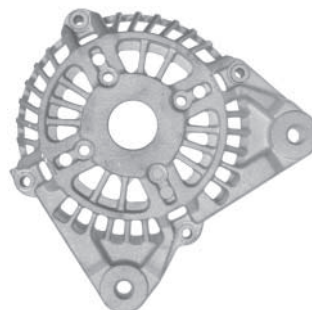

234380

Servicing A2TB6481
Bearing: Cargo 140093

Replacing MITSUBISHI

Brackets S.R.E.

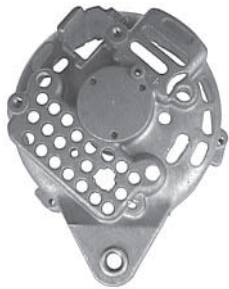

135012

Servicing A2T26391, -27011
Citroen, Peugeot
Bearing: Cargo 140081



137133

Replacing A641T57070, MD611225
Servicing A1T01991, -40791, -40891
Bearing: Cargo 140232

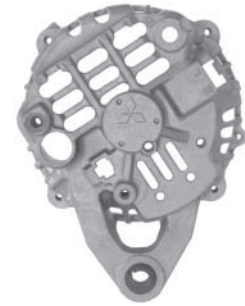

138046

Replacing A643X08371
Servicing A2T19991, -20191, -20192C
Bearing: Cargo 140419



136575

Replacing A641T91670
Servicing A2T13894
Bearing: Cargo 140419



137295

Servicing A2T16471, -41391
Bearing: Cargo 140081



138394

Replacing A643X13971
Servicing A2T05892A, -33191, -33991, -38977
Bearing: Cargo 140419



136751

Replacing A641T65270, -65970, -90570
Servicing A2T02271, -02471, -02572, -02577, -02971, -02977, -03171, -03471, -03477, -03979, -04277, -48691, -49977
Bearing: Cargo 140232



137561

Replacing A643X10671
Servicing A5T22578, -22583, -70178, -70183, -70283
Bearing: Cargo 140084

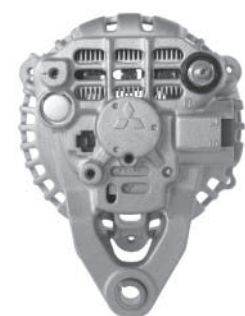

138910

Replacing A641T74170, -79470
Servicing A2T05892
Bearing: Cargo 140419

Replacing MITSUBISHI

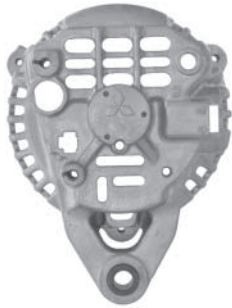

139194

Replacing A643X06881
Servicing A2T04578, -04598, -04599,
 -06091, -06092, A3T06791
Bearing: Cargo 140419



139545

Replacing A643X13771
Servicing A2T05772X, A5T03391,
 -03391A, -03677, -03777
Bearing: Cargo 140419



230216

Replacing A641T65470
Servicing A2T01384, -01483, -01583,
 -01683, -01783, -02084, -06384, -09884,
 -10083, -27883, -35583, -49377, -49476
Bearing: Cargo 140434



139266

Replacing A202B66272, MD611008
Servicing A5T15684, -15784, -15884,
 -16084, -16384, -20484 -21684, -21984
Bearing: Cargo 140417

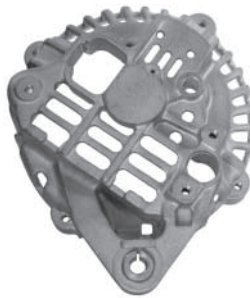

230212

Replacing A641T78570
Servicing A3T02792, -02892, -03392,
 -03393, -03471, -03492, -03493
Bearing: Cargo 140234

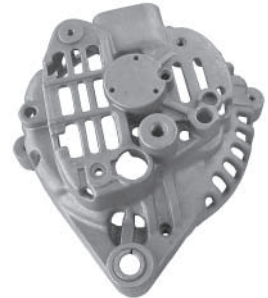

230598

Servicing A3T01598, Ford
Bearing: Cargo 140419



139349

Replacing A643X09571
Servicing A2T03291, -07292, -07292A
Bearing: Cargo 140419

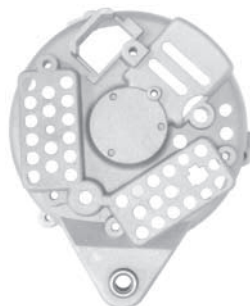

230215

Servicing A3T03291, -03291A, -03291B,
 -03292, -03298B, -03298, -03298A,
 -03298B, -45191, -45291, -45291A,
 -45291C, -45291D, -45291F, -45292,
 -45292C, -45292D, -45292F, -45298
Bearing: Cargo 140417

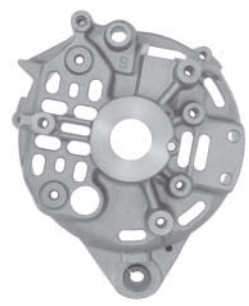

230646

Replacing A643X11271
Servicing A2T14376, -14876
Bearing: Cargo 140434

Replacing MITSUBISHI



230675

Servicing A2T32692, A2TA2492
Bearing: Cargo 140419



230769

Replacing A643X15771
Servicing A2T36478, A2TN0678, -0684
Bearing: Cargo 140084

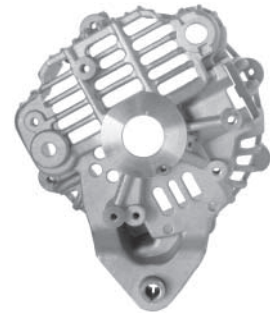

231337

Servicing A3TN1791
Bearing: Cargo 140084

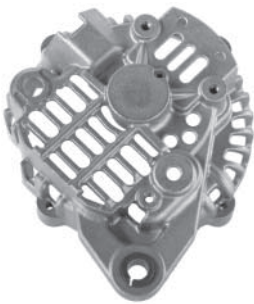

230749

Replacing A643X18471
Servicing A2TA1099, -6099, -6099A, A2TB1298
Bearing: Cargo 140419



230946

Servicing A2T14591, -28791, A2TA2392
Bearing: Cargo 140419



231401

Replacing A641T75770, -75870
Servicing A2T09291, -09391, -09493, -22991
 12 V.
 W/ regulator and rectifier
Bearing: Cargo 140419



230750

Replacing A643X14971
Servicing A3T08491, -08491A
Bearing: Cargo 140419



231334

Replacing A641T29470
Servicing A2T12671, -16371, -16871, AQ2240K1, -2245K1, -2250K1
Bearing: Cargo 140081



231546

Servicing A2T14592
Bearing: Cargo 140419

Replacing MITSUBISHI



231547

Replacing A642X14370, -43070
Servicing A2T82899, A3T11278
Bearing: Cargo 140084

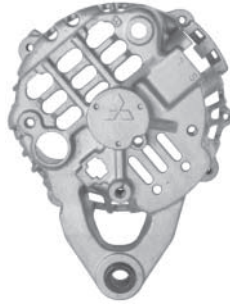

231574

Replacing A643X08271
Servicing A5T00972, -01271
Bearing: Cargo 140419



231830

Replacing A642X14270
Servicing A2T37976
Bearing: Cargo 140084



231548

Servicing A4TA0091D
Bearing: Cargo 140588



231826

Servicing A5TA4391
Bearing: Cargo 140419



231889

Replacing A641T65070, -66770
Servicing A2T02671, -02771, -02871, -07071, -09691, -28291, -48791
 12 V.
 W/ regulator and rectifier
Bearing: Cargo 140419

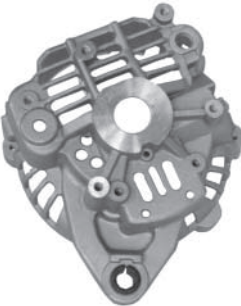

231549

Replacing A642X23170
Servicing A3T15099
Bearing: Cargo 140084



231829

Servicing A1T03791, -03792, -05792
Bearing: Cargo 140419



232209

Replacing A641T38870, MD607679
Servicing A2T41477, -43183, -43583
 12 V.
 W/ regulator and rectifier
Bearing: Cargo 140417

Replacing MITSUBISHI

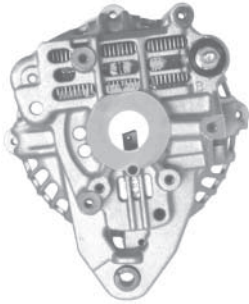

232231

Replacing A641T67870, A642X16070
Servicing A3T00599, -03778, -04999, -05499, -06099, -07399, -07483, -07983
 12 V.
 W/ regulator and rectifier
 Bearing: Cargo 140434

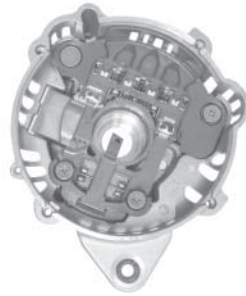

233384

Replacing A642X14370
Servicing A3T11278
 W/ regulator and rectifier
 Bearing: Cargo 140084



233521

Servicing A5TA0991
 Bearing: Cargo 140419



232386

Servicing A2T81192, -81292, -81391
 Bearing: Cargo 140419



233385

Replacing A642X14170
Servicing A2T38391, -81791
 W/ regulator and rectifier
 Bearing: Cargo 140419

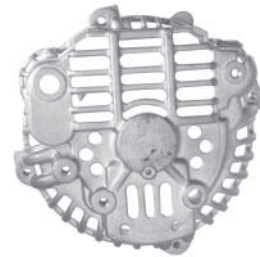

233809

Servicing A3TA5591, -5591A
 Bearing: Cargo 140419



232387

Servicing A2TA3791, -7491
 Bearing: Cargo 140419

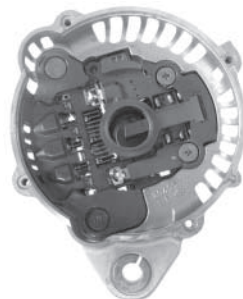

233386

Replacing A642X20370
Servicing A3T09699
 W/ regulator and rectifier
 Bearing: Cargo 140419

233810

Replacing A641T97770
Servicing A2T34892, -35091, -35092, -36392, -38291, -38491, -38891, -38892, -39992, -40091, -40092, A2TA3491
 Bearing: Cargo 140419

Replacing MITSUBISHI

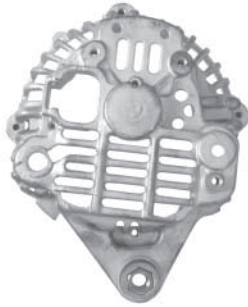

233902

Replacing A642X26770
Servicing A3TA0791
Bearing: Cargo 140419



234329

Servicing A3TA0591, -0591C, -0591D,
 -0591E, -0591F, -0593C, -0593D
Bearing: Cargo 140419

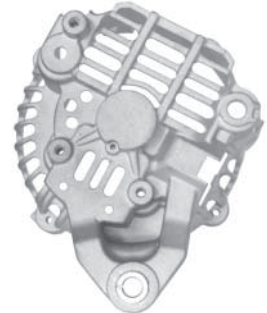

234381

Replacing A642X52170
Servicing A3TA4399
Bearing: Cargo 140419

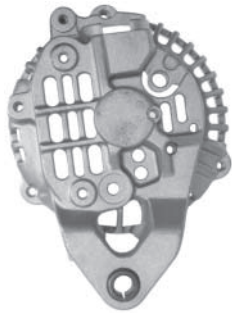

234174

Servicing A2T48292, -48298
Bearing: Cargo 140234



234334

Servicing A7T03371, -03371A, -03771,
 -03771A
Bearing: Cargo 140419

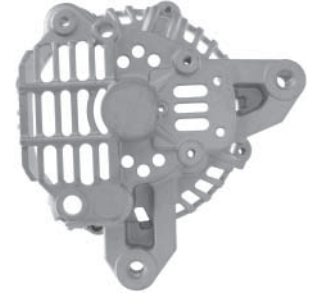

234565

Servicing A3TA6491, A3TB0891
Bearing: Cargo 140419



234175

Servicing A7T00171, -00191, -00591,
 -00598, -01991
Bearing: Cargo 140419

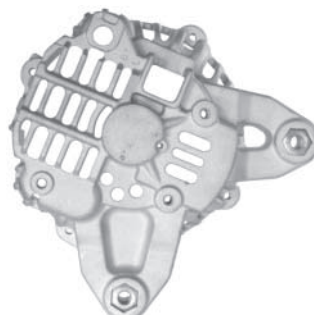

234358

Servicing A2TB6481
Bearing: Cargo 140419



234975

Replacing A641T78870
Servicing A3T03099



Replacing MITSUBISHI

Bracket Parts

235183

Servicing A5TA7792
Bearing: Cargo 140419



134276 Std pkg 10 **A**
10.5 x 17/22 x 15 mm
Mounting bushing, S.R.E.



233338
Servicing A2T81292, -81391,
A2TA3791, A2TB1491
10 x 17 x 20 mm
Mounting bushing, S.R.E.



134277 Std pkg 10 **A**
10 x 16.5 x 15.3 mm
Mounting bushing, S.R.E.



234575
Servicing A3T03099, A3TA4399,
A5T04392
10.5 x 17.1 x 16 mm
Mounting bushing

235303

Replacing A642X22170
Servicing A3TA1191, A, A3TA0791A,
A3T14491



134278 Std pkg 10 **A**
8.5 x 15.3 x 15.3 mm
Mounting bushing, S.R.E.



231494
Servicing A2T48298
I.D. 29 mm
Bearing retainer



135281 Std pkg 10
8.3 x 15/22 x 16 mm
Mounting bushing, S.R.E.

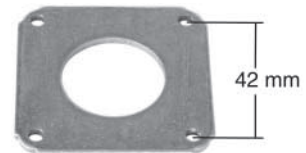

233912
Servicing A2T14591, -28792, -35177,
-37391, -37391ZC, -38391, -38391ZC,
-39391A, -4692A, -4692B, -81791, -82378,
-82899, -82899AT, -82899ZT, -83491A
I.D. 29 mm
Bearing retainer

Replacing MITSUBISHI

Regulators



130615

Replacing RQB-2220D1
Servicing Mazda, Mitsubishi
 12 V.
 Electronic

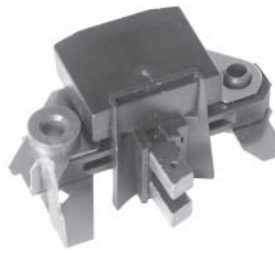

131289

Replacing A866T02970
Servicing A2T20972
 12 V.
 Terminals S-L



131464

Replacing A866X01670
Servicing A2T24884
 12 V.
 Terminals R-L



130616

Replacing RLB-2220A5
Servicing Mazda, Mitsubishi
 12 V.
 Mechanic

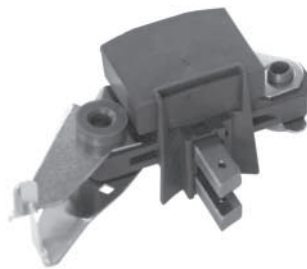

131290

Replacing A866T03470
Servicing A1T32084
 12 V.
 Terminals R-L



131471

Replacing A866X09171
Servicing A2T49377
 12 V.
 Terminals S-L

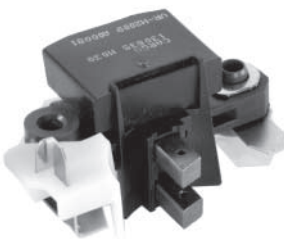

130835

Replacing A866T03270
Servicing A2T26172
 12 V.
 Terminals R-L

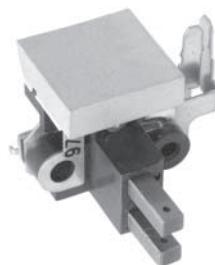

131463

Replacing A866X02170
Servicing A1T32779, -23479, -32799,
 A2T25479
 12 V.
 Terminals R-L



131516

Replacing A866T03570
Servicing A6T65199
 24 V.
 Terminals R-L

Replacing MITSUBISHI



131517

Replacing A866T06670
Servicing A5T70283
 24 V.
 Terminals R-L

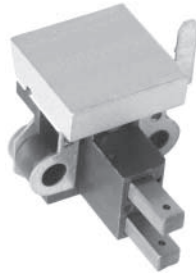

131520

Replacing A866X02370
Servicing A1T70379
 24 V.
 Terminals R-L

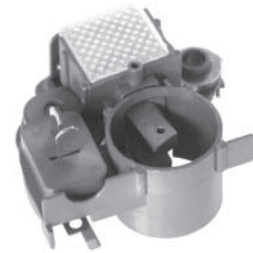

131524

Replacing A866X04872, -08672, -11682,
Servicing A1T03672, -03872, -03972
 12 V.
 Terminals R-L
Repair circuit: Cargo 133243



131518

Replacing A866T01070
Servicing A3T77071
 24 V.

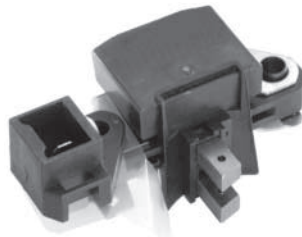

131521

Replacing A866T03870, -05670
Servicing A2T26391, -27091
 Citroen
 12 V.
 Terminal L



131525

Replacing A866X04571
Servicing A5T30277, A2T40571B,
 -40577B, A5T41277
 12 V.
 Terminal L



131519

Replacing A866T03170
Servicing A2T70776
 24 V.



131523

Replacing A866T05270
Servicing A2T02271, -02471, -03471,
 -03477, -48176, -48195, -48691
 12 V.
 Terminal S-L
Repair circuit: Cargo 133244



132041

Replacing A866X07572
Servicing A5T16471, -30977, -31177,
 -31671, B101-18-300A
 12 V.
 Terminals R-L
Repair circuit: Cargo 133243

Replacing MITSUBISHI

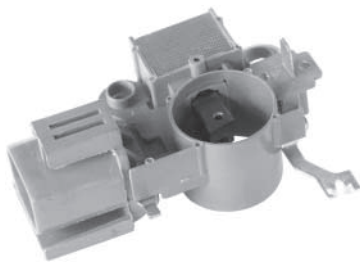

132101

Replacing A866X12772
Servicing A2T05772
 I.C. alternators w/ internal fan
 12 V.
 Terminals S-L
Repair circuit: Cargo 133246

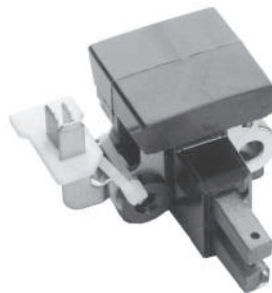

132716

Replacing A866X01871
Servicing A2T23577
 12 V.
 Terminals S-IG-L

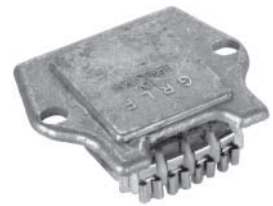

133005

Replacing 37600-11500
 Hyundai
 12 V.
 Terminals G-R-L-F



132102

Replacing A866X06470, -06471, -08071
Servicing A2T46395B
 I.C. alternators w/ internal fan
 12 V.
 Terminals S-L
Repair circuit: Cargo 133246

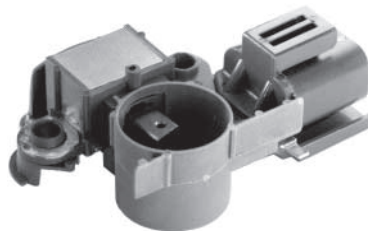

132936

Replacing A866X08472, 23125-58S10
Servicing A5T41592B
 12 V.
 Terminals S-L
Repair circuit: Cargo 133245

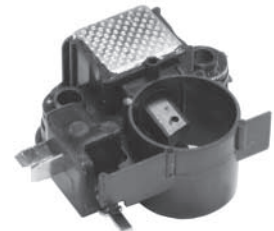

133254

Replacing A866X06272
Servicing A2T45272
 12 V.
 Terminals S-L
Repair circuit: Cargo 133244



132476

Replacing A866X05870
Servicing A3T35278
 12 V.
 Terminals S-L

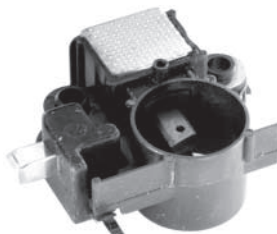

133004

Replacing A866X14172
Servicing A1T02952, -04592
 12 V.
 Terminals R-L
Repair circuit: Cargo 133243



133746

Replacing A866X09270, -09271
Servicing A2T01976, -49577
 12 V.
 Terminals S-L

Replacing MITSUBISHI

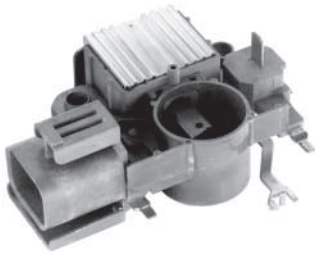

134026

Replacing A866X17172
Servicing A5T00877, -00972, -01777, -02777
 12 V.
 Terminals S-L
Repair circuit: Cargo 232608

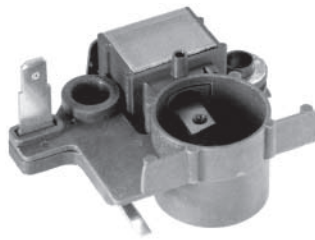

134754

Replacing A866X07470
Servicing A5T31772, Ford
 12 V.
 Terminal L



135033

Replacing A866X11870, -11872
Servicing A1T03191
 12 V.
 Terminals D-IG-L



134087

Replacing A866X08270
Servicing A1T01691
 12 V.
 Terminals C-IG-L

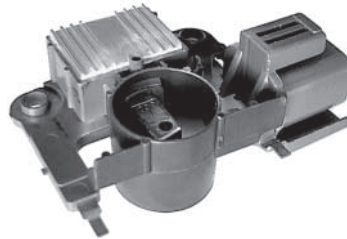

135030

Replacing A866X13272, -20782, -21482
Servicing A2T02394, -13894, -14694, -18792, A3T05192, E9DF-10300B, -BB
 12 V.
 Terminals S-L

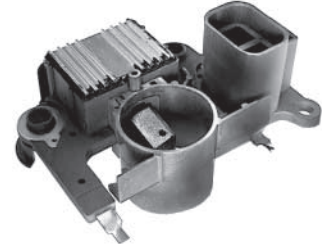

135034

Replacing A866X15770
Servicing A1T03391
 12 V.
 Terminals S-L

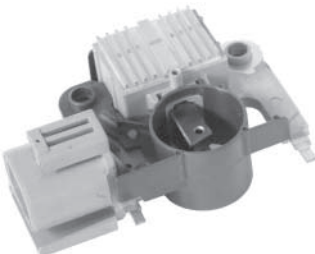

134088

Replacing A866X14572, -17972
Servicing A2T17574, -19991, A3T06791, A5T00192, -01577, -01977, 23100-77A10
 12 V.
 Terminals S-L
Repair circuit: Cargo 232608

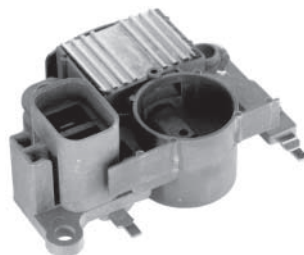

135032

Replacing A866X17072
Servicing A2T13977, -18177, -18277, -19877
 12 V.
 Terminals S-L
Repair circuit: Cargo 232608

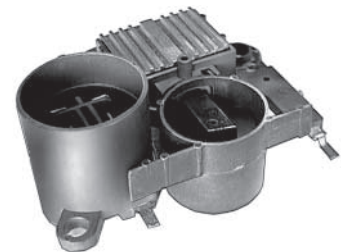

135064

Replacing A866T38570, A866X13671
Servicing A1T02291, -02292, -04892, A5T04072, -04092, -04292, -06291
 12 V.
 Terminals C-FR-IG-L
Repair circuit: Cargo 232609

Replacing MITSUBISHI

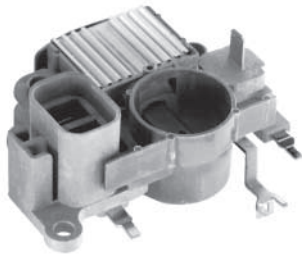

135147

Servicing A5T02377
Mazda Pick-up 2,2E
12 V.
Terminals S-L
Repair circuit: Cargo 232608



136549

Replacing A866X12682
Servicing A3T01877, -01877B, -04177,
-04178, -05676
12 V.
Terminals S-L



136952

Replacing A866X16672, PN40-18-W70
Servicing A2T28976
12 V.
Terminals S-L

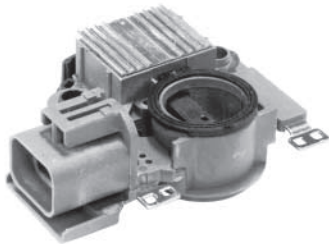

135233

Replacing A866X20472, -20572
Servicing A2T33191, -33891, -33991,
-35177, -36578, -38977, A3T07592
12 V.
Terminals S-L

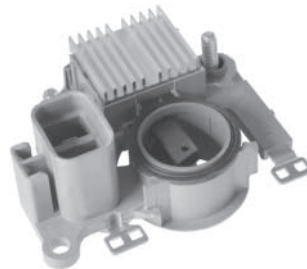

136649

Replacing A866X22272, -23172, -23183
Servicing A2T34892, -34991, -34992,
-35091, -35092, -36391, -36392, -38291,
-38391, -38491, -38891, -38892, -39992
12 V.
Terminals S-L

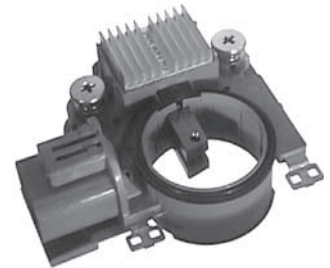

137075

Replacing A866X24972, MD618735
Servicing A2T36478, -37976, -82377,
-82378, A2TN0076, -0199, -0299, -0399,
-0499, -0599, A3TN0078, -0199, -0299
12 V.
Terminals S-L

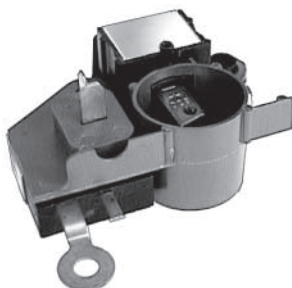

135917

Replacing A866X06082
Servicing A2T47891, A2T49177
12 V.
Terminals R-L



136731

Replacing A866X11772, MD611743
Servicing A4T01493, -01793, -01893,
-02991, -03091, -03191
12 V.
Terminals S-L
Repair circuit: Cargo 232607

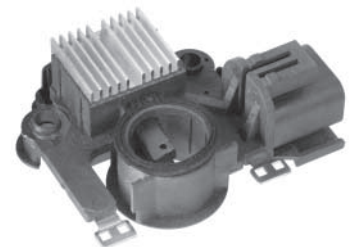

137182

Replacing A866X23072, 23215-64J13
Servicing A2T33493, -33493A, -33593,
-33593A
12 V.
Terminals S-L

Replacing MITSUBISHI

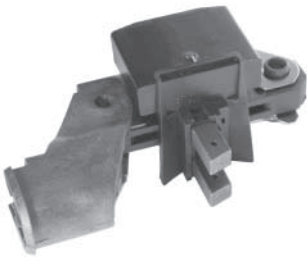

137396

Replacing A866T06870, ME700635
Servicing A2T72185, -72188, -72189, -72190, -72286, -72383, -72483, -72883, -72893, -72985, -72986, -72987, -72999
 24 V.
 Terminals R-L

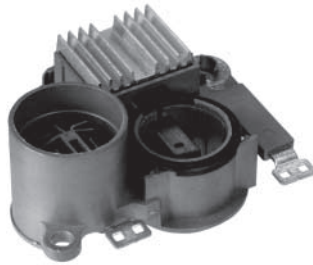

138296

Replacing A866X26641
Servicing A5T06491ZC
 12 V.
 Terminals D-FR-IG-L



138631

Replacing A866X17272
Servicing A2T09591
 12 V.
 Terminals S-L



137397

Replacing A866T02070
Servicing A1T70783
 24 V.
 Terminals R-L

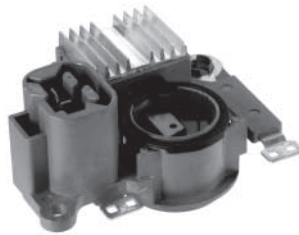

138309

Replacing A866X26172, MD618845
Servicing A1T06391, -06672, -06791, -06891, A1TA0091, -0291, -0491, -0591, -0691, -0791, -0891, -0991, -1091
 12 V.
 Terminals R-L

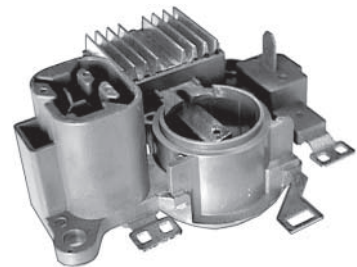

138632

Replacing A866X24572, -28472
Servicing A7T2071, -2071A, -2077, -2077A, A7TA0477, -0483, Clark fork lift
 12 V.
 Terminals R-L

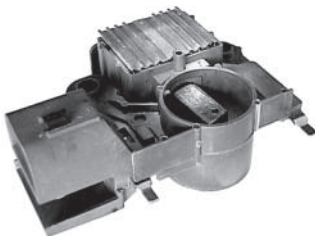

137748

Replacing A866X13970, -13971
Servicing A3T01596MA, -01598MA, -01598NA
 12 V.
 Terminals I-S(D)-A
Repair circuit: Cargo 232608

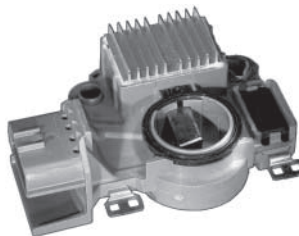

138340

Replacing A866X34172, MD619268
Servicing A2TA4991, -5191, -5192, -5391, A2TB0892, A3TA1691, -2291A, -4691, -4791, -5291, -5391, -5491
 12 V.
 Terminals G-S-L-F



138872

Replacing A866X35472
Servicing A2TB0091, Z599-18-300A
 12 V.
 Terminals P-D
 Field control unit

Replacing MITSUBISHI

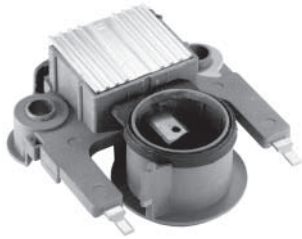

139043

Replacing A866X23200
Servicing A2T13391C, -14591, -14592, -17491, -28792, -32692, -34591, -37691, -37691A, -81891, Citroen, Peugeot 12 V.
Repair circuit: Cargo 137478



139689

Replacing A866X14370
Servicing A1T02674, Peugeot 12 V.
 Terminal L

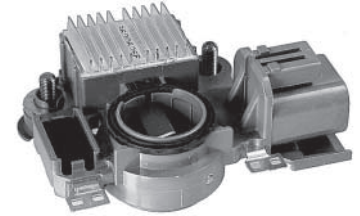

230043

Replacing A866X36272
Servicing A2T33593C, -82491A, A5T06891B, A5TA0591A 12 V.
 Terminals S-L

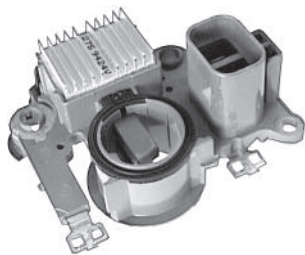

139110

Replacing A866X27572, ME701363
Servicing A2TA3098, A3T09198, -09199, -09698, -09699, -09799 12 V.
 Terminals S-L

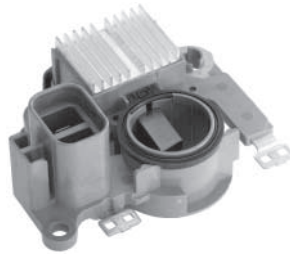

230003

Replacing A866X22282, -22283
Servicing A7T03771, 23100-50K15 12 V.
 Terminals S-L

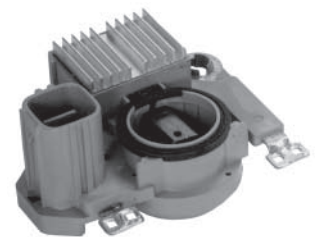

230260

Servicing A5TA0991, -4591, AHGA24, -35 12 V.
 Terminals C-FR-IGN-L

Volt setting 14.5 V.



139667

Replacing A866X23772, -23773
Servicing A5T07091ZC, A5TA2891, A7T01874, -02171, -02471, -02491, -02591 12 V.
 Terminals D-IG-L

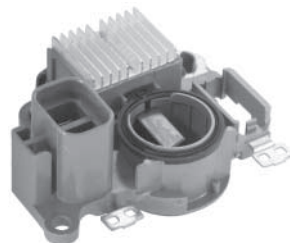

230042

Replacing A866X32672
Servicing A7T03371A, -03771A 12 V.
 Terminals S-L

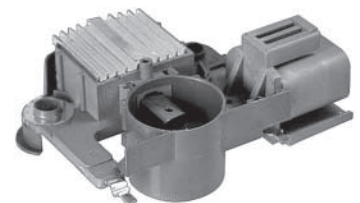

230262

Replacing A866X15170, -17470
Servicing A3T00491, -00491MA, -00896, -00896MA, -12691, -12792 12 V.
 Terminals I-A

Replacing MITSUBISHI

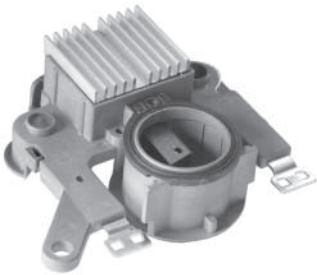

230502

Servicing A2TA1991, -1991D, -1994, -2091, -2091D, -2091E, -2091F, -2094, -2094B, -2094C, -2094D, A3TA0591, -0592, Citroen, Peugeot
12 V.

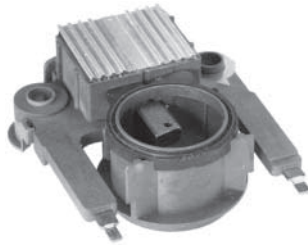

230990

Servicing A4T00891, -00891C, -00891D, -00891E, -00991, -00991D, -00991E, -02891, -02891A, -02891B, -02892, -02892A, -02893, -02893A, -02893B
12 V.
Terminal L

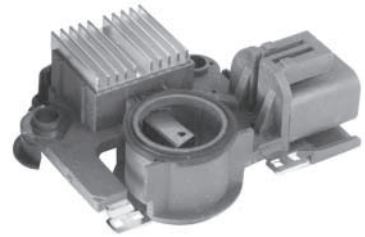

231182

Replacing A866X25872
Servicing A7T02874, -02974, -02991, -03091, A7TA0574
12 V.
Terminals R-L

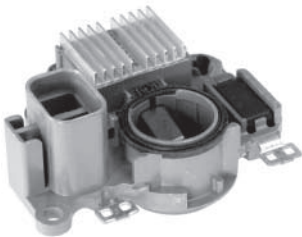

230885

Replacing A866X39772, MD618569
Servicing A2T38892A, -39991A, -39992A, -40092A, A2TA2871A, -5991A
12 V.
Terminals S-L
W/ capacitor

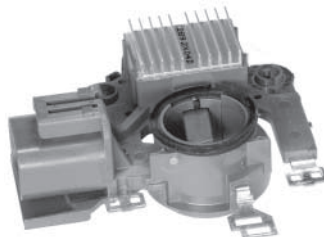

231075

Replacing A866X25272, -28972
Servicing A2T37291, -37391, -39091
12 V.
Terminals S-L

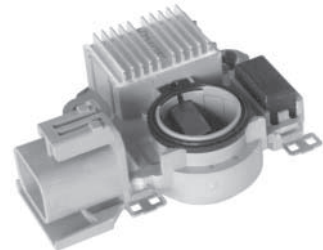

231510

Replacing A866X37272
Servicing A2T05892C, -33191A, -33991A, -36578A, A2TA1099A, -6099A
12 V.
Terminals S-L
For rectifiers w/o diode trio

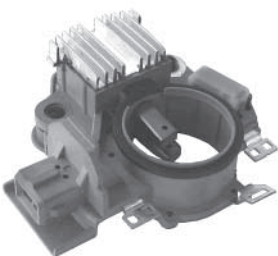

230985

Replacing A866X40371
Servicing A3TN1791
12 V.
Terminals L-W

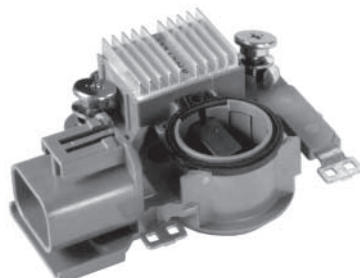

231151

Replacing A866X27772
Servicing A2T39291, -39391, -A3991, -A5891
12 V.
Terminals S-L

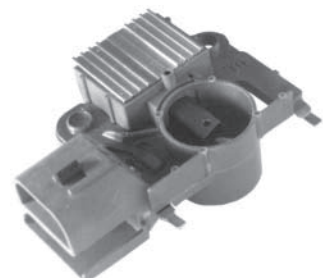

232449

Replacing A866X14070, -14072
Servicing A3T01496, -01496MA
12 V.
Terminals I-S(L/IG)-A
Repair circuit: Cargo 232607

Replacing MITSUBISHI

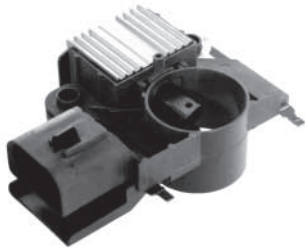

232450

Replacing A866X15472
Servicing A4T00796, -03591
 12 V.
 Terminals I-S(D)-A
Repair circuit: Cargo 232608



233379

Replacing A866X14672
Servicing A3T76682
 24 V.
 Terminals R-L



234304

Replacing A866X28372, ME701399
Servicing A3TN5188, -5283, -5288,
 -5379, -5387, -5399, -5487, -5776, -5883,
 -5986, -6493
 24 V.
 Terminals R-L

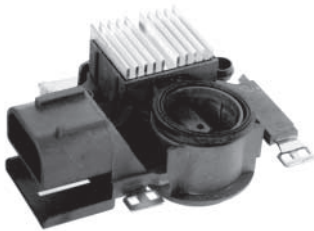

232451

Replacing A866X24272
Servicing A6T41491, -41591
 12 V.
 Terminals I-D-A

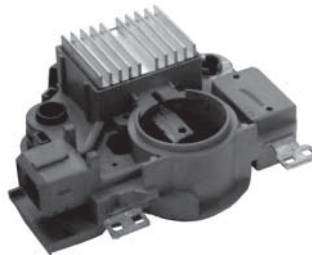

233745

Replacing A866X35872
Servicing A5TA2591, -4391, -6591
 12 V.
 Terminals DF-I



234309

Servicing A2TB4791, -A, -B, A3TB0891B,
 -A, A3TA6491, -A
 12 V.

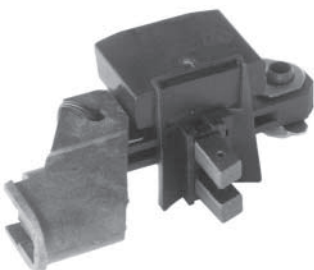

232453

Replacing A866T08570, ME700755
Servicing A2T32386, -32583
 12 V.
 Terminals R-L



233777

Replacing R8T10471, -10472, 3Y 6693
 Caterpillar
 24 V.
 Terminals R-L

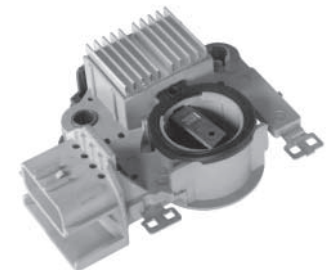

234313

Replacing A866X28572, MD618957
Servicing A2T82791, -82792,
 A2TA0891ZC, -0892ZC, A5TA0291
 12 V.
 Terminals G-S-L-F

Replacing MITSUBISHI



234541

Replacing A866X31882
Servicing A5TA1091, -1091ZC, -1191, -1191ZC, -4891, -4891ZC
 12 V.
 Terminals: L-IG-FR

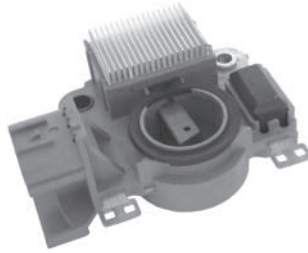

235102

Servicing A2TB2891, -ZC, 23700-AA370
 12 V.



235355

Replacing A866x29582
Servicing A2TA2191
 12 V.
 Terminals: IG-L-C-FR

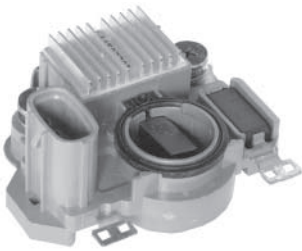

234631

Replacing A866X44582
Servicing A5TA4791, -5591
 12 V.
 Terminals: L-IG-FR



235279

Replacing A866X42572,
Servicing A5TA3891, -3891A, -6191, 6191ZC, -6191ZE
 12 V.

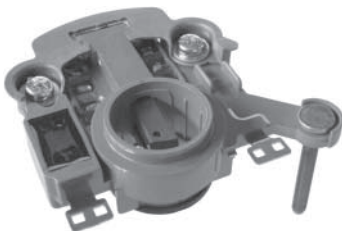

235078

Servicing A2TB2291A, -4891A, -4891B, -4891C
 12 V.



235328

Replacing A866X47072, A866X38172
Servicing A2T80591A, A3T13191B, A3T13291B, A3TA0791A, A3TA1191A
 12 V.



Replacing MITSUBISHI

Regulator Parts



133243 A

Servicing A866X04870, -04871, -04872, -05470, -05471, -05472, -06072, -07570, Cargo 131524, 132041, 133004
12 V.
4 pin repair circuit w/ terminals R-L



133244 A

Servicing A866X05272, -06272, -09071, -09971, -06470, -06471, Cargo 131523, 133254
12 V.
4 pin repair circuit w/ terminals S-L



133245 A

Servicing A866X08472, Cargo 132936
12 V.
5 pin repair circuit w/ terminals S-L and right hand plug



133246 A

Servicing A866X08070, -08071, -12270, -12272, -12282, Cargo 132101, 132102
12 V.
5 pin repair circuit w/ terminals S-L and left hand plug

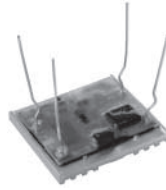

137478

Servicing A866X23200, Cargo 139043
12 V.
Repair circuit

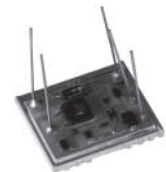

232607

Servicing A866X11772, -14072, -19072, Cargo 136731, 232449
Terminal S-L
Repair circuit



232608

Servicing A866X00179, -13970, -13971, -14570, -14572, -15472, -17072, -17972, -18972, -21072, Cargo 134026, 134088, 135032, 135147, 137748, 232450
Terminals S-L
Repair circuit

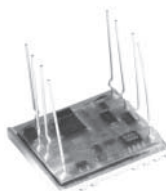

232609

Servicing A866T38570, A866X13670, -22072, Cargo 135064
Terminals C-FR-IG-L
Repair circuit



134717 Std pkg 5 A

Servicing I.C. alternators w/ internal fan
Insulator



137207

Servicing Cargo 133004, 134026, 134088, 134344, 135032, 135033, 134064, 135233
Insulator

Replacing MITSUBISHI

Rectifiers



133866

Replacing A860T14670
Servicing A7T30371, -30392, -30792
 6 diodes
 W/ diode trio and capacitor
 B+ terminal M6

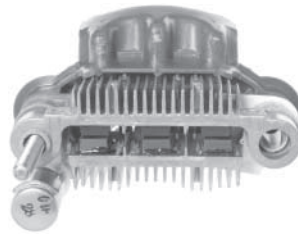

132715

Replacing A860T27870
Servicing A5T16471
 6 diodes
 W/ diode trio and capacitor
 B+ terminal M5

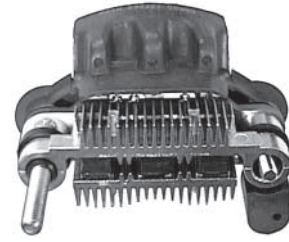

133263

Replacing A860T20570, 23124-53A10
Servicing A5T41592B
 6 diodes
 W/ diode trio and capacitor
 B+ terminal M6

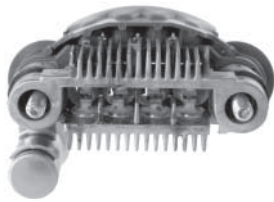

138961

Replacing A860T21670, MM502507
Servicing A0T25171, -25271, -25371, -25373, -25471
 8 diodes
 W/ capacitor
 B+ terminal M6

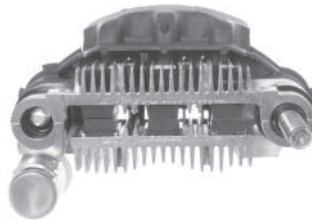

132789

Replacing 23830-KA070
Servicing A1T02592
 6 diodes
 W/ diode trio and capacitor
 B+ terminal M6

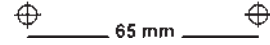
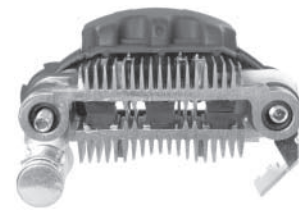

133756

Replacing A860T18870, 23124-17B10
Servicing A5T01897, -22971B, -22997, -22997B
 6 diodes
 W/ diode trio and capacitor
 B+ terminal M5



132039 HD

Replacing A860T11970, -13370
Servicing A1T02592, -33474, A2T40391, -40491, A5T30574, -31177, -31571, -31971, -32071, -32277, -40374, Ford
 6 diodes
 W/ diode trio and capacitor
 B+ terminal M5

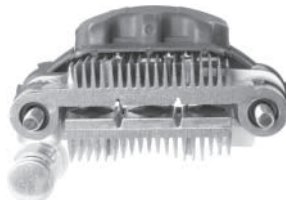

132791

Replacing A860T16770, MD611254
Servicing A1T01991, -40791, -40891
 Hyundai
 6 diodes
 W/ diode trio and capacitor
 B+ terminal M5

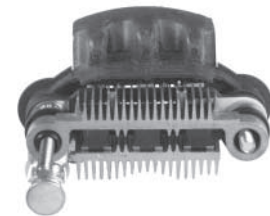

136980

Replacing A860T17470, -17870
Servicing A5T22877, -22877A, -30871, -30977, -30977A, -31277, -31671, -40377, -41474, -41477
 6 diodes
 B+ terminal M5

Replacing MITSUBISHI

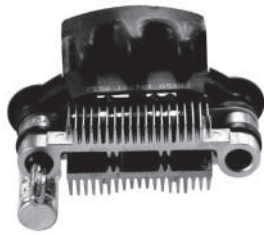

136981

Replacing A860T19870
Servicing A5T30874, -32571
 6 diodes
 W/ capacitor
 B+ terminal M5

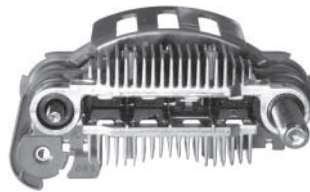

231777

Replacing A860X61670
Servicing A7T03371A
 W/ 6 diodes
 B+ terminal M8



131541

Replacing A860T06470
Servicing A1T70379
 6 diodes
 W/ diode trio
 B+ terminal M5

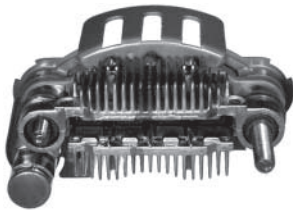

138396

Replacing A860T40570
Servicing A7T02071, -02071A, -02077,
 -02077A, -02491, -02591, -02691, -03277
 8 diodes
 W/ capacitor
 B+ terminal M6



131538

Replacing A860T11270
Servicing A1T03476, -23377, -31374,
 -33377, -45292, AH2040H4
 6 diodes
 W/ diode trio and capacitor
 B+ terminal M5



132087

Replacing A860T04370, -11070
Servicing A1T02871, -23871, -24471,
 -25077, -25083, -70783
 6 diodes
 W/ diode trio
 B+ terminal M5

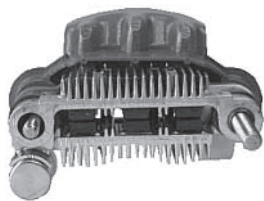

230650

Replacing A860T17070, A860X17077
Servicing A5T40176B, -40195, -40195B,
 -41094, -41094B
 6 diodes
 B+ terminal M6

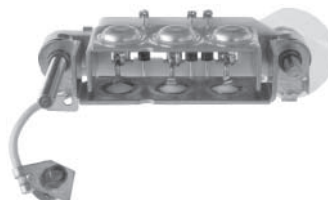

131539

Replacing A860T06570
Servicing A1T23579, -32779, -32799
 6 diodes
 W/ diode trio
 B+ terminal M5

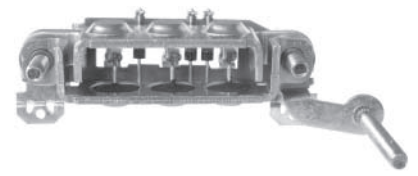

132761

Replacing A860T08570, S205-24-510
Servicing A1T32176, -33576, -33676,
 -71076, -71176
 6 diodes
 W/ diode trio and capacitor
 B+ terminal M5

Replacing MITSUBISHI

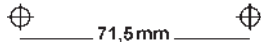

133264

Replacing A860T04870
Servicing A4T25172, -25191, -25199
 6 diodes
 B+ terminal M5

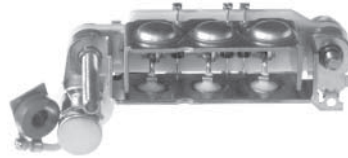

234558

Replacing A860T06970
Servicing A2T23579, -32779, -32799
 6 diodes
 W/ diode trio and condenser
 W/ terminal L
 B+ terminal M5

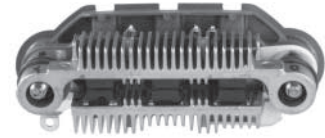

132465

Replacing A860T14370, 23230-08E15
Servicing A2T45799
 6 diodes
 W/ diode trio
 B+ terminal M5



134373

Servicing A3T03291, -45191, -45291
 Citroen
 6 diodes
 W/o diode trio
 B+ terminal M5



234559

Replacing A860T07170
Servicing A1T22971, -31371, -31374,
 A3T03291, -03292, -03298, -03298B
 6 diodes
 W/ diode trio and capacitor
 B+ terminal M5

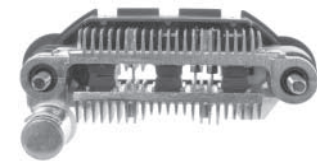

132466

Replacing A860T13170, -22570, -22670
Servicing A2T43791, -09691
 6 diodes
 W/ diode trio and capacitor
 B+ terminal M5



138974

Replacing A860T09470
Servicing A1T22581, -24371, -24471,
 -25477, -25483, -70883, AH4020Z1
 6 diodes
 W/o diode trio
 B+ terminal M5

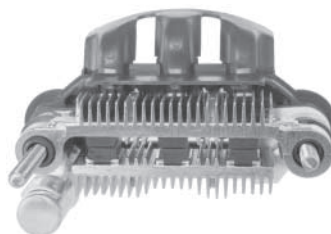

132040

Replacing A860T17970
Servicing A2T41677, -43372, -44672,
 -44991, -47474, -48594, -4904
 6 diodes
 W/ diode trio and capacitor
 B+ terminal M5

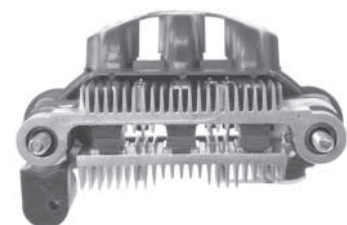

132467

Replacing A860T17270, 23124-08E16
Servicing A2T45771A, -48298
 6 diodes
 W/ diode trio and capacitor
 B+ terminal M5

Replacing MITSUBISHI

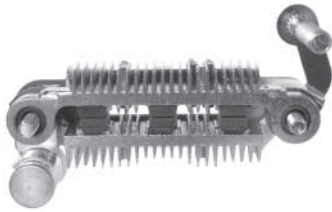

132468

Replacing A860T22370
Servicing A2T01077, -01384, -01483, -01583, -01683, -01783, -01976, -02084
 6 diodes
 W/ diode trio and capacitor
 B+ terminal M6



132792

Replacing A860T20270, 23124-58L10
Servicing A2T02394, -02394B, -48472
 6 diodes
 W/ diode trio and capacitor
 B+ terminal M5

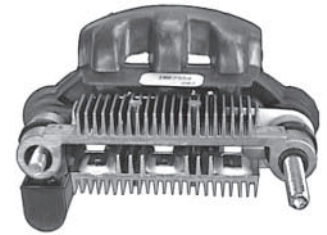

133539 HD

Replacing A860T16470
Servicing A2T08577, -09291, -09392, -09493, -22991, -42599A, -43099, -45494
 6 diodes
 W/ diode trio and capacitor
 B+ terminal M6

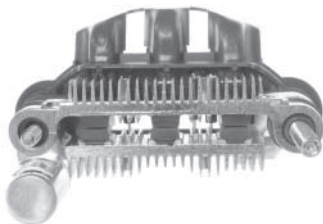

132469

Replacing A860T27170
Servicing A2T05892, -42571, -45771
 6 diodes
 W/ diode trio and capacitor
 B+ terminal M6

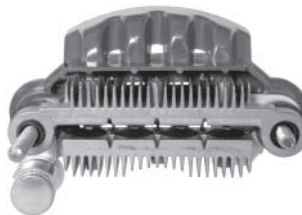

132794

Replacing A860T18570
Servicing A2T46591
 8 diodes
 W/ diode trio and capacitor
 B+ terminal M5

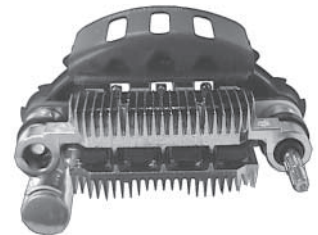

134027

Replacing A860T32570
Servicing A5T00877, -01977, -02777
 8 diodes
 W/ diode trio and capacitor
 B+ terminal M5

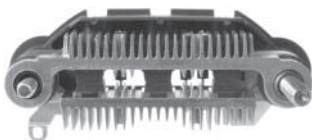

132787

Replacing A860T13070, -13870
Servicing A2T42599, -45272A, -48195
 6 diodes
 W/ diode trio
 B+ terminal M6

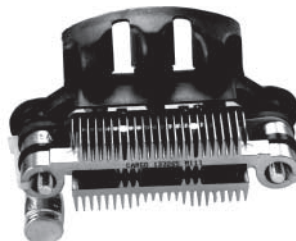

133265

Replacing A860T17770, MD 611307
Servicing A2T03072, -03892, -13571, -49972, -49977
 6 diodes
 W/ diode trio and capacitor
 B+ terminal M5

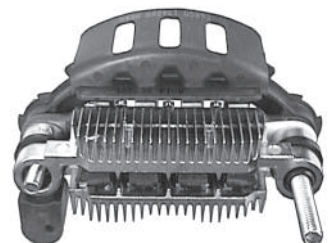

134295

Replacing A860T27270
Servicing A5T00192, 23100-77A10
 8 diodes
 W/ diode trio and capacitor
 B+ terminal M6

Replacing MITSUBISHI

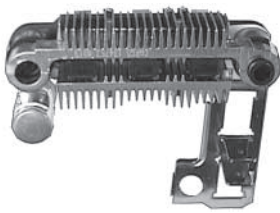

134753

Servicing A5T31772
 Ford Escort, Fiesta, Orion
 6 diodes
 W/ diode trio and capacitor
 B+ terminal M5

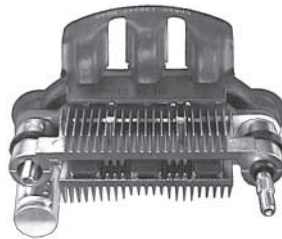

135247

Replacing A860T27070
Servicing A2T05772
 6 diodes
 W/ diode trio and capacitor
 B+ terminal M5

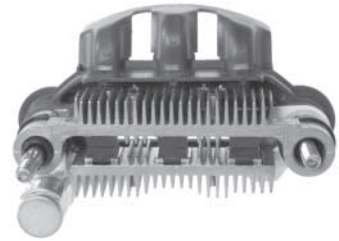

136733

Replacing A860T20070, -20099
Servicing A2T47794,B
 6 diodes
 W/ diode trio and capacitor
 B+ terminal M6



135215

Replacing A860T 30370, -39770
Servicing A5T 01271, A1T 03191
 8 diodes
 W/ diode trio and capacitor
 B+ terminal M6

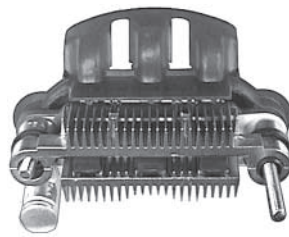

135248

Replacing A860T24570
Servicing A3T03591, -3691, -04191, -45272A
 6 diodes
 W/ diode trio and capacitor
 B+ terminal M5

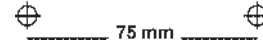
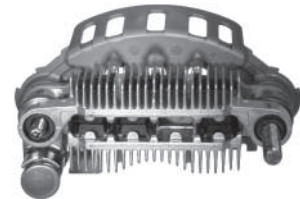

139195

Replacing A860T37070
Servicing A5T03391, -05091, -07091, -07191, -07491, A5T04492A, -B
 6 diodes
 W/ diodes and capacitor
 B+ terminal M6

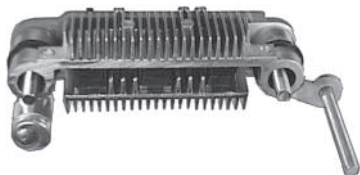

135228

Replacing A860T19370
Servicing A2T01976, -08799, -47199, -49577
 6 diodes
 W/ diode trio and capacitor
 B+ terminal M5



137669 BN

Replacing A860T31570, 23830-KA090
Servicing A1T03292, -03391, -03791
 6 diodes
 W/ diode trio and capacitor
 B+ terminal M6

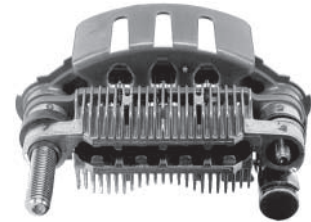

230041

Replacing A860X43570
Servicing A5T05372, -05472, -05473, -05473A, -06891, -06891A, -06991
 8 diodes
 W/ diode trio and capacitor
 B+ terminal M8

Replacing MITSUBISHI

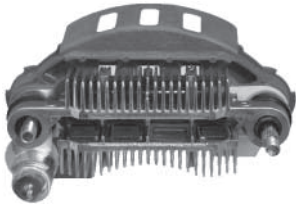

230261

Servicing A5TA0991, -4591, AHGH24, -35
6 diodes
W/ diode trio and capacitor
B+ terminal M6



234629

Replacing A860X45270
Servicing A5TA109ZC
8 diodes
W/ diode trio

235297

Replacing A860X83370 
Servicing A5TA 7091, -ZC, -ZE, -7191
8-30 Amp. diodes
W/o diode trio
B+ terminal M6 x 24 mm



231339

Servicing A5TA2591
8 diodes
B+ terminal MX

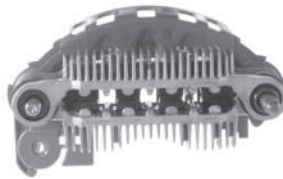

234632

Replacing A860X74470
Servicing A5TA5591
8 diodes

131221

Replacing A860T06070
Servicing A2T12371, -16371, -16471, -23477, -30271, A3T30271, A5T10271, -15171, -15371, -15471, -20377, -20571
6 diodes
W/ diode trio and capacitor

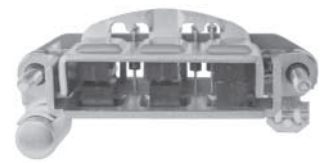

232606

Replacing A860T38570
Servicing A5T04292
W/ diode trio

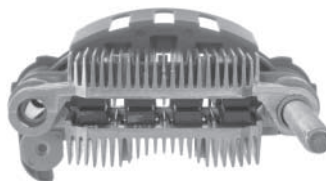

235266

Servicing A1TA 2291, -2293 
8 diodes
W/o diode trio
B+ terminal M8 x 27.5 mm

131542

Replacing A860T10770
Servicing A5T21472, -30171
6 diodes
W/ diode trio and capacitor
B+ terminal M5



Replacing MITSUBISHI

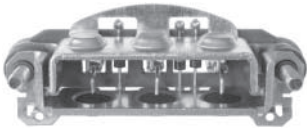

131543

Replacing A860T08470
Servicing A5T00272, -20871, -20872, -20972, -21871, -21897
 6 diodes
 W/ diode trio
 B+ terminal M5

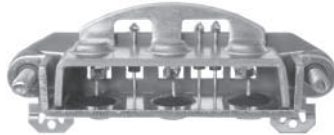

130833

Replacing A860T05170
Servicing A2T24971, AQ2245G1, AQ2250C31, AQ2250G1
 6 diodes
 W/ diode trio



132463

Replacing A860T08770, MD607680
Servicing A2T27176, -40483, -40484, -41477, -41483, -41599, -43183, -43583
 6 diodes
 W/ diode trio and capacitor
 B+ terminal M5

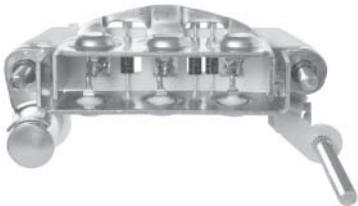

132130

Replacing A860T08270
Servicing A5T15584, -15684, -15884, -22484
 6 diodes
 W/ diode trio and capacitor
 B+ terminal M5

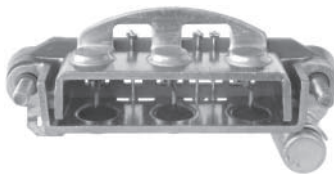

131544

Replacing A860T07270
Servicing A2T23494, -25071, -25081, -25171, -26072, -40571
 6 diodes
 W/ diode trio and capacitor
 B+ terminal M5

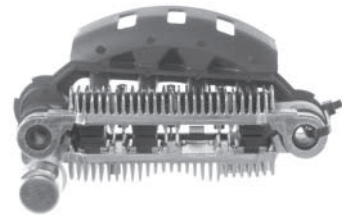

134297

Replacing A860T28670
Servicing A3T01596, -01598
 6 diodes
 W/ diode trio and capacitor
 B+ terminal M6

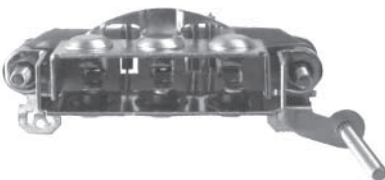

136726

Replacing A860T14570, ME700555
Servicing A5T70178, -70183, -70283
 6 diodes
 B+ terminal M5

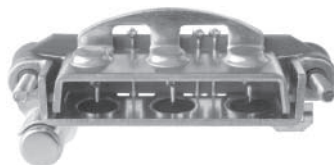

131545

Replacing A860T10470
Servicing A2T40377
 6 diodes
 W/ diode trio and capacitor

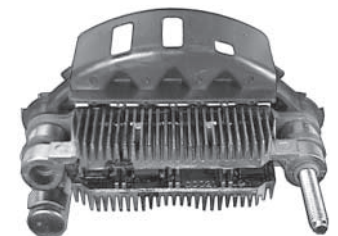

135041

Replacing A860T34070
Servicing A2T19991
 Ford
 6 diodes
 W/ diode trio and capacitor
 B+ terminal M6

Replacing MITSUBISHI

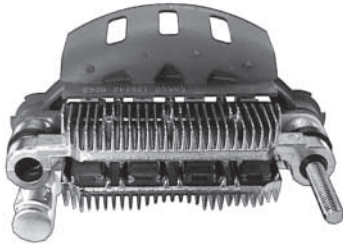

135042

Replacing A860T23270, MD611586
Servicing A3T00692
 Dodge
 8 diodes
 W/ diode trio and capacitor
 B+ terminal M6

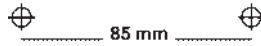

135948

Replacing A860T38970
Servicing A2T33191
 8 diodes
 W/ diode trio and capacitor
 B+ terminal M5



136978

Replacing A860T37670, -39170
Servicing A2T33991
 6 diodes
 W/ diode trio and capacitor
 B+ terminal M5

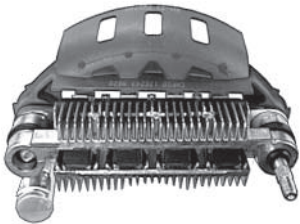

135249

Servicing A3T01691, 23700-AA060
 8 diodes
 W/ diode trio and capacitor
 B+ terminal M5

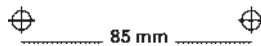

136552

Replacing A860T41670
Servicing A2T36478
 6 diodes
 W/ diode trio and capacitor
 B+ terminal M5



136979

Replacing A860T38770
Servicing A2T34892, -34991, -34992, -35091, -35092, -36391, -36392, -38491
 6 diodes
 W/ diode trio and capacitor
 B+ terminal M6

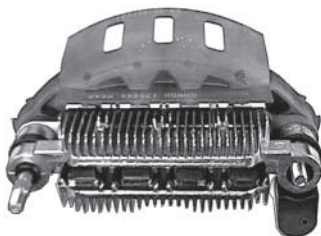

135260

Replacing A860T29970, -29999
Servicing A2T14694, -18792
 8 diodes
 W/ diode trio and capacitor
 B+ terminal M5

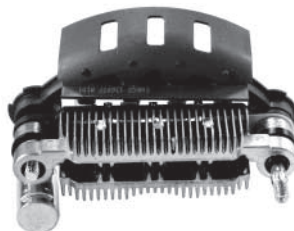

136977

Replacing A860T33470, -38270
Servicing A2T17574, -18874, -34477
 8 diodes
 W/ diode trio and capacitor
 B+ terminal M5



137076

Replacing A860X49270, MD618950
Servicing A2TN0076, -1199, -1481, -1798, -2476
 8 diodes
 W/ capacitor
 B+ terminal M8

Replacing MITSUBISHI



137077

Replacing A860X42770, MD618734
Servicing A2T37976, A2TN0199, -0299, -0399, -0499, -0599
 6 diodes
 W/ diode trio and capacitor
 B+ terminal M8



137861

Servicing A2T13391C, -13391D, -13391E, Citroen, Peugeot
 6 diodes
 W/ diode trio and capacitor
 B+ terminal M8

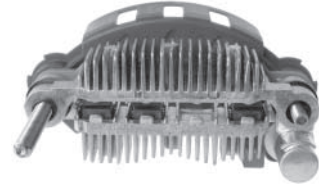

138893

Servicing A2T81291, -81391, Chrysler
 6 diodes
 W/ capacitor
 B+ terminal M6



137849

Replacing A806T42670, MD618752
Servicing A2T38391, -81791
 A2TA0891, -0991, -2691, -2871, -3091
 6 diodes
 W/ diode trio and capacitor
 B+ terminal M8



138628

Replacing A860T39870
Servicing A2T35791, -35791A
 8 diodes
 W/ diode trio and capacitor
 B+ terminal M5

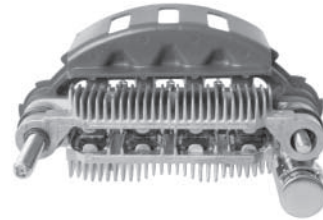

139196

Replacing A860T37170, A860X37171
Servicing A2T27594, -27594A
 8 diodes
 W/ diode trio and capacitor
 B+ terminal M6

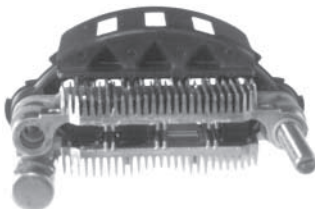

137860

Servicing A2T81891, A2TA2591, Ford
 6 diodes
 W/ diode trio and capacitor
 B+ terminal M6

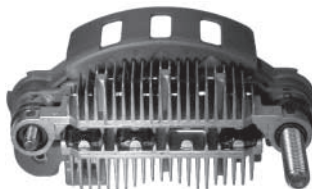

138873

Replacing A860T57870
Servicing A2TB0091, Z599-18-300A
 6 diodes
 B+ terminal M8

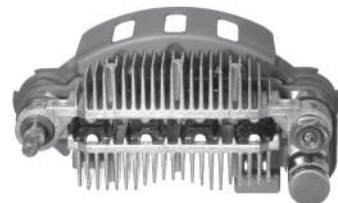

139197

Replacing A860X45170
Servicing A2T38091, -82491, A2TA4091
 8 diodes
 W/ diode trio and capacitor
 B+ terminal M5

Replacing MITSUBISHI

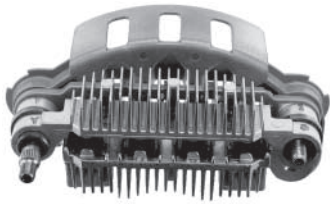

230046

Replacing A860X63270
Servicing A2T82491A, -82491B, A2TA4091A, -4092A
 8 diodes
 B+ terminal M5

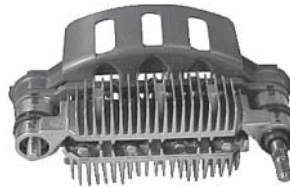

230660

Replacing A860X68670
Servicing A2T33191A, A2TB0191, -0191A, -0191B
 8 diodes

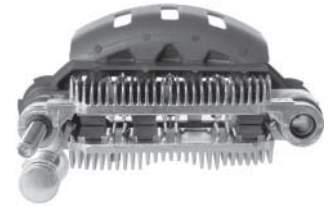

233511

Servicing A3T01496
 6 diodes
 W/ diode trio
 B+ terminal M6 x 23 mm



230593

Servicing A2T32692, Ford
 8 diodes
 W/ diode trio and capacitor
 B+ terminal M6
 8-30 Amp. Diodes

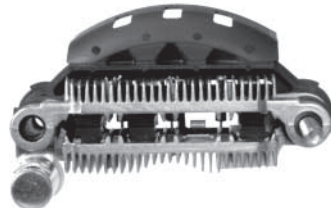

232448

Replacing A860T23170
Servicing A3T00792
 6 diodes
 B+ terminal M6

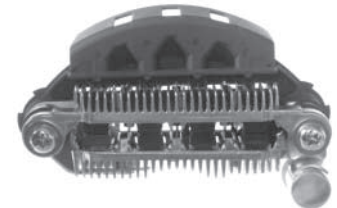

233746

Servicing M3T00491, -00896, -12691, -12792
 8 diodes
 W/ diode trio



230643

Replacing A860T58070
Servicing A2TB1298
 8 diodes
 B+ terminal M8



232628

Servicing A2T20091, -20091ZC
 8 diodes
 W/ diode trio
 B+ terminal M8 x 29 mm



233748

Servicing A2TA1991, -1991D, -1994, -1994B, -1994C, -1994D, -2091D, -2091E, -2091F, -2094, -2094B, -2094C, -2094D
 6 diodes
 B+ terminal M5 x 17 mm

Replacing MITSUBISHI

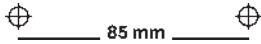

233749

Replacing A860T06370
Servicing A2T25479, -25679
 6 diodes
 W/ diode trio



234702

Replacing A860X61970
Servicing A2TA7691
 6 diodes
 W/o diode trio
 B+ terminal M5 x 15 mm



235265

Servicing A2TB4791, -4791a, -4791b
 6 diodes
 W/o diode trio
 B+ terminal M5 x 16 mm

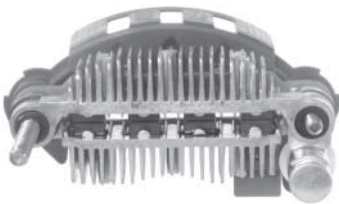

234643

Servicing A2TA3791
 8 diodes
 W/ condenser, w/o diode trio
 B+ terminal M6

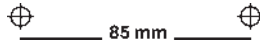
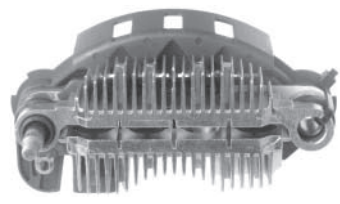

234814

Servicing A2T4891B, A2TB4891A, -C
 6-50 Amp. Avalanche diodes
 B+ terminal M5

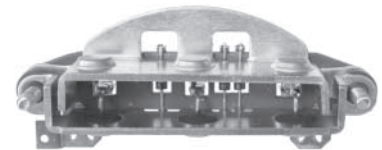

131227

Replacing A860T07370
Servicing A3T21371, -21677, -32772, -32877, -33772, -33977, A5T23277
 6 diodes
 W/ diode trio

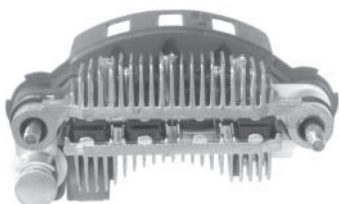

234647

Replacing A860T41070
Servicing A2T19276, -36684, -36776, -36876, -38776, -74684, -74776, -74876, -75376, -75576
 8 diodes
 W/ diode trio and condenser



234827

Replacing A860T42470
Servicing A2T38291, -39991, -39992, -83591, -83592
 8-30 Amp. diodes
 W/ condenser and diode trio
 B+ terminal M6 x 25 mm

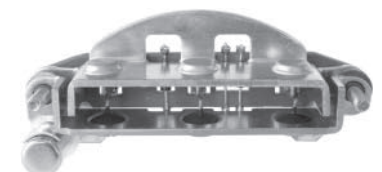

131547

Replacing A860T10370
Servicing A2T41599A, -47299, A3T34391, -35091
 6 diodes
 W/ diode trio and capacitor
 B+ terminal M5

Replacing MITSUBISHI

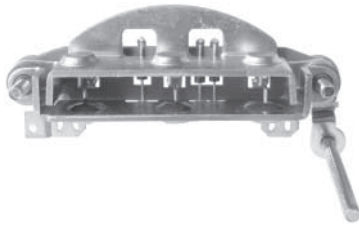

132464

Replacing A860T11770
Servicing A3T35278
 6 diodes
 W/ diode trio
 B+ terminal M5



133755

Replacing A860T06270, 23124-W1715
Servicing A3T33678, -33684, -33698
 6 diodes
 W/ diode trio
 B+ terminal M5



135882

Replacing A860T38670, -40270
Servicing A3T08491, -08591
 8 diodes
 W/ diode trio and capacitor
 B+ terminal M5

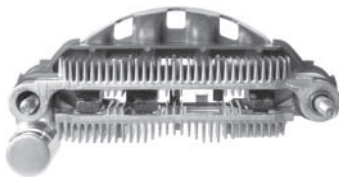

132714

Replacing A860T26470
Servicing A3T01877, -01877A, -35278, -35278A, -35299A
 6 diodes
 W/ diode trio and capacitor
 B+ terminal M5



135229

Replacing A860T 30170
Servicing A3T 03891, 23700-AA061
 8 diodes
 W/ diode trio and capacitor
 B+ terminal M5

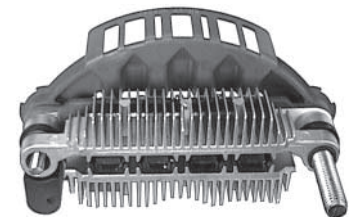

135900

Replacing A860T33970
Servicing A4T02591
 8 diodes
 W/ diode trio and capacitor
 B+ terminal M8

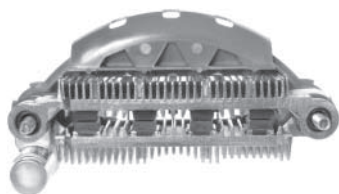

132793

Replacing A860T23070, MD611564
Servicing A3T02392, -41876, -41892, -45694
 8 diodes
 W/ diode trio and capacitor
 B+ terminal M5

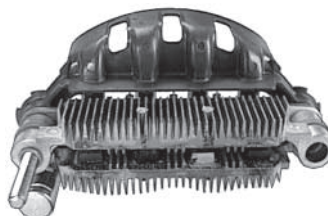

135252

Replacing A860T35270
Servicing A4T00796
 8 diodes
 W/ diode trio and capacitor
 B+ terminal M6

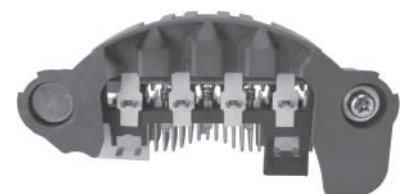

135901

Replacing A860T36770
Servicing A3T07592
 8 diodes
 W/ diode trio and capacitor
 B+ terminal M8

Replacing MITSUBISHI



137486

Replacing A860T23370, -26070
Servicing A3T08183, A4T01493
 8 diodes
 W/ diode trio and capacitor
 B+ terminal M6

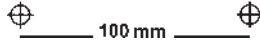
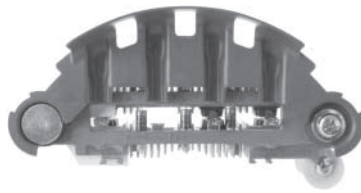

139269

Replacing A860T36070
Servicing A4T01793, -01893, -02991, -03091
 6 diodes
 W/ diode trio and capacitor
 B+ terminal M6



230884

Replacing A860X58270, MD619280
Servicing A3T13191B, -13291B, A3TA1191A, -2291A, -4891, -5291, -5391
 W/ 8 diodes, w/o diode trio
 B+ terminal M8



139111

Replacing A860X47070, ME701716
Servicing A3T08699, -08799, -09698, -09699, -09799, A3TA3098, -8199
 6 diodes
 W/ diode trio and capacitor
 B+ terminal M8

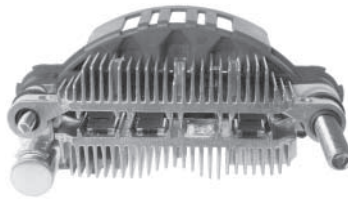

139427

Servicing A3TA0591, -0591C, -0591D, -0591E, -0591F, -0593C, -0791
 6 diodes
 W/ diode trio and capacitor
 B+ terminal M8

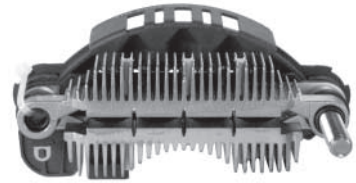

231079

Servicing A3TN1791
 W/ diode trio
 B+ terminal M8

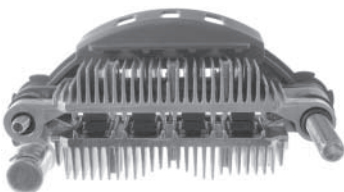

139222

Servicing A4T02891, -A, -B, A4T02892, -A, A4T03292, -A
 8 diodes
 W/ diode trio and capacitor
 B+ terminal M8



139949

Replacing A860X42970, MD618745
Servicing A3T11678, A3TN0699, -1578
 8 diodes
 W/ diode trio and capacitor
 B+ terminal M8



231423

Replacing A860X42870, MD618741
Servicing A3T11278, -15099, A3TN0399, -0499
 6 diodes
 B+ terminal M8

Replacing MITSUBISHI

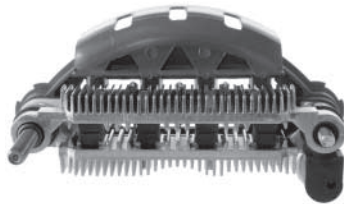

233515

Replacing A860T31770, A860X31799
Servicing A3T05192
 8 diodes
 W/ diode trio
 B+ terminal M6 x 23 mm



233851

Replacing A860X49570, -52670
Servicing A3TN5283, -5288, -5293, -6493
 8 diodes
 W/ diode trio and capacitor
 W/ terminal W
 B+ terminal M8 x 27 mm



234700

Replacing A860X48270, -68070
Servicing A3T14491, A3TA0991, -0991A, -1191, -2391, -2578, -4481
 8 diodes
 W/ diode trio and capacitor
 B+ terminal M8 x 30 mm



233518

Servicing A6T41491
 8 diodes
 W/ diode trio and capacitor
 B+ terminal M5



234305

Replacing A866X52570, ME701569
Servicing A3TN5188, -5379, -5386, -5387, -5399
 6 diodes
 W/ condenser



132460

Replacing A860T02170
Servicing AH2250C42, A2T20972, -30571
 O.D. 110 mm, 6 diodes
 B+ terminal M5



233651

Servicing A4T00891, -00991, -03392, -03492, A4TA0091C, -0091D
 8 diodes
 W/ diode trio
 B+ terminal M8 x 27 mm



234310

Servicing A3TB0891B
 8 diodes
 W/o diode trio
 B+ terminal M5 x 17 mm



132462

Replacing A860T06870
Servicing A2T70671, -70772, -70774, -71683, A3t67171, A4025Q10
 O.D. 116 mm, 6 diodes
 W/ diode trio and capacitor

Replacing MITSUBISHI



136739

Replacing A860T01770
Servicing A1T21971, -21972, -22074, -22581, -22871, -31471, -71474
 O.D. 115 mm, 6 diodes
 B+ terminal M5

Rectifier Parts



133701 A
 Connector



133980 Std pkg 100 **A**
 Paper insulator



135255 Std pkg 5
 Connector

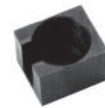

136024 Std pkg 10
 Holder for diodes



135256 Std pkg 5
 Connector



136295 Std pkg 10
Servicing A860T29970, -29999,
 Cargo 135260
 Holder for diode trio



135280 Std pkg 5
 Connector



136304 Std pkg 10
 Insulator for diode trio

Replacing MITSUBISHI

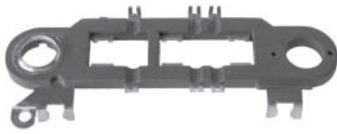

136330 Std pkg 10
Servicing A7T00191, -02691
 Insulator for diode trio



233333 Std pkg 5
 M6 x 45 mm,
 KNURL O.D. 6.5 mm
 B+ terminal



Diode Trios

138379
Servicing A3T03392, -03393, -03471,
 -03492



137212
Servicing Cargo 134297, 135041,
 135042, 135249, 135260
 Insulator for rectifiers



233334 Std pkg 5
 M6 x 46 mm,
 KNURL O.D. 8.7 mm
 B+ terminal



138947
Servicing A7T00191, -00591, -02491,
 -02691, 31400-60A10, -60A11, -60B31,
 -60B50



136424 Std pkg 5
 M5 x 41.5 mm,
 KNURL O.D. 6.3 mm
 B+ terminal



233332 Std pkg 5
 M5 x 41 mm,
 KNURL O.D. 5.5 mm
 B+ terminal

Also see Diode Chapter
page 780

Replacing MITSUBISHI

Diodes



133704 Std pkg 5 **A**
30 Amp. 200 V.
Positive thin square diode
Low profile block type diode



133705 Std pkg 5 **A**
30 Amp. 200 V.
Negative thin square diode
Low profile block type diode



231576 Std pkg 5
35 Amp. 200 V.
Positive thin square diode



231577 Std pkg 5
35 Amp. 200 V.
Negative thin square diode



231578 Std pkg 5
40 Amp. 200 V.
Positive thin square diode



231579 Std pkg 5
40 Amp. 200 V.
Negative thin square diode



236888 **N**
Servicing A3TB0771, -5099
50 Amp. 24-32 V. Avalanche
Positive



236889 **N**
Servicing A3TB0771, -5099
50 Amp. 24-32 V. Avalanche
Negative

Slip Rings



133409 Std pkg 5 **A**
O.D. 23 mm, Shaft 12.5 mm, L. 28 mm



135140 Std pkg 5 **A**
Same as 133409, but w/ steel rings
O.D. 23 mm, Shaft 12.5 mm, L. 28 mm



137313
Servicing A2T01483, -01583, -01683,
-01783, -10083
O.D. 32.5 mm, Shaft 17 mm, L. 29.3 mm



138413 Std pkg 5
O.D. 32.5 mm, Shaft 15/15.05 mm,
L. 30.8 mm

Replacing MITSUBISHI



230490

O.D. 35.40 mm, Shaft 17 mm, L. 32.67 mm

Brush Boxes



135814

Replacing A649T09270, A649X03970
Servicing AG2035A, -A2, -N, -N1,
 AG2050N11, -14, -21, -24, AH2250E2
 12 V. Complete w/ brushes

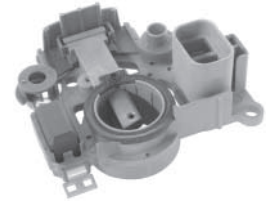

235001

Servicing M3TA4191, -4191ZC, -749,
 -749ZC
 12 V. Complete w/ brushes



231567

Servicing A880T40770, -45070, -62070
 O.D. 33.15 mm, Shaft 17.55 mm, L. 32.6 mm

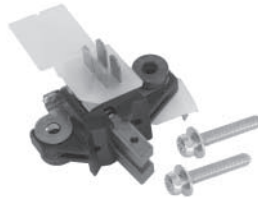

136112

Replacing A649X04070, MD602797
Servicing A1T71474, A3T66374, -67172,
 -67174, AG2035T2, -3, -9, AT4025N13
 12/24 V. Complete w/ brushes



233787

Servicing A880T33170
 O.D. 41 mm, Shaft 25.6 mm, L. 29.3 mm



138728

Servicing A2T81292, -81391,
 A2TA3791, A3T14292
 12 V. Complete w/ brushes

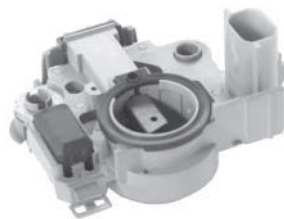

234500

Servicing A2TB1491, -1491ZC, -2491,
 -2492, -2791ZC, -7491ZC
 12 V.
 Complete w/ brushes and condenser

Replacing MITSUBISHI

Brush Box Parts



135263

Replacing A389D01601, -01901,
MD618465
Brush spring



135264 Std pkg 10

Replacing A389C01101, MD602227
Brush spring

Brush Sets



140350

Replacing A648C00570
7 x 6 x 14 mm
12 V.



140351 A

Replacing A648C01570
7 x 6 x 17 mm
12 V.



140352 A

Replacing A648D01671
7 x 6 x 18 mm
12 V.



140353 A

Replacing A648D02070
7 x 6 x 18 mm
12 V



140354 A

Replacing A648D01970
7 x 6 x 23 mm
12 V.



140392

Replacing E48812519A
7 x 6 x 17 mm
12 V.



140437 A

Replacing A648D02570, MD 611035
5 x 8 x 18 mm
12 V.



140576 Std pkg 10 A

Replacing A648D03070, MD611689
5 x 8 x 23 mm
12 V.

Replacing MITSUBISHI

Also see Bearing Chapter page 821



140577 Std pkg 10 **A**
Replacing A648C02970, MD611566
 5 x 8 x 18 mm
 12 V.



140817 Std pkg 10
Replacing A647X50170, -50270, -50870
 5 x 8 x 23 mm
 12/24 V.

141239
Servicing A4TR5188ZT, A4TR5191ZT
 4.86 x 7.87 x 20 mm
 12/24 V.

Special Bearings



140231 Std pkg 5 **A**
Replacing S930P17170, B 8-74D
Servicing I.C. alternators w/ internal fan
 8/22 x 11 mm
 W/ snap ring, S.R.E.



140232 Std pkg 10 **A**
Replacing S930P17970, B8-79D
Servicing I.C. alternators w/ internal fan
 8/23 x 11 mm
 W/ snap ring, S.R.E.



140234 Std pkg 10 **A**
Replacing S930P18570, B8-85D
Servicing I.C. alternators w/ internal fan
 8/23 x 14 mm
 W/ snap ring, S.R.E.



140411 Std pkg 8
Replacing S930P18470, B15-83D
 15/47 x 18 mm



140417 Std pkg 10 **A**
Replacing S930P61201, 6201V
 12/32 x 10 mm
 W/ snap ring

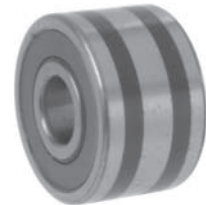

140419 Std pkg 5 **A**
Replacing S930P63670, SL8AD5LHI
 8/23 x 14 mm
 W/ 2 teflon tolerance rings



140420 Std pkg 10 **A**
Replacing S930P63070, B15-86W3
 15/47 x 14 mm

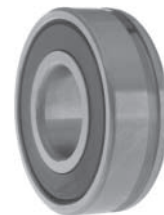

140432 Std pkg 10 **A**
Replacing 6202VVNCXCM, 6202V
 15/35 x 11 mm
 W/ snap ring

Also see Bearing Chapter page 821

Replacing MITSUBISHI



140434 Std pkg 10
Replacing S930P18301, -18370, -64301, -64370, B 15-69D
 15/35 x 13 mm
 W/ snap ring

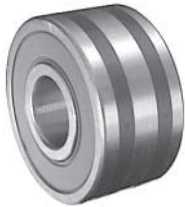

140588 Std pkg 5 **A**
Replacing S930P64570, SC0081LHIA
 10/27 x 14 mm
 W/ 2 teflon tolerance rings



140589 Std pkg 8 **A**
Replacing S930P64470, B17-107D
 17/47 x 18 mm



140754 Std pkg 5
Replacing S930P80570, B17-116DG
 17/52 x 18 mm



140783 Std pkg 6
Replacing S930P64870, MD618338
Servicing A4T01493, -01793, -01893
 17/47 x 24 mm



141012
Replacing 6202 LLBC3
 15/35 x 11 mm
 W/ 2 teflon tolerance rings



141236
Replacing 5930P35670, -80870
 15/42 x 13 mm
 W/ 2 teflon tolerance rings

Fan & Pulleys



133883
Replacing A628T35370
Servicing A5T15684, -15784, -15884
 Fan: O.D. 133 mm,
 Pulley: O.D. 93.5 mm, Bore 15 mm,
 Fan and pulley, C-belt type



133884
Replacing A628T44370
Servicing A2T27477, -41477, A3T35577
 Fan: O.D. 138 mm,
 Pulley: O.D. 73.7 mm, Bore 15 mm,
 Fan and pulley, B-belt type



135265
Replacing A628T46270
Servicing A2T43183, -43583
 Fan: O.D. 138 mm,
 Pulley: O.D. 93.5 mm, Bore 15 mm,
 Fan and pulley, C-belt type

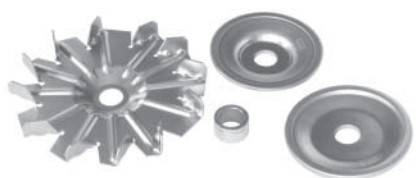

135267
Replacing A628T55770, MD611492
Servicing A2T01483, -01583, -01683
 Fan: O.D. 138 mm,
 Pulley: O.D. 83.5 mm, Bore 17 mm,
 Fan and pulley, C-belt type



Replacing MITSUBISHI

Also see Pulley Survey page 809



135274

Replacing A628T55570
Servicing A2T01976, -14376, -14876
 Fan: O.D. 133 mm,
 Pulley: O.D. 78.5 mm, Bore 17 mm,
 Fan and pulley, B-belt type



230319

Replacing A628T36970
Servicing A2T25578, -25584, -25598
 Fan: O.D. 133 mm,
 Pulley: O.D. 83.4 mm, Bore 15 mm, W. 22.9 mm
 Fan and pulley, B-belt type



133343

Replacing A679C00770
Servicing A2T48292, -81391
 O.D. 61.2 mm, Bore 17 mm, W. 21.1 mm,
 4 grooves



135596

Replacing A628T46670
Servicing A2T41599A
 Fan: O.D. 138 mm,
 Pulley: O.D. 82 mm, Bore 17 mm, W. 68.1 mm
 Fan and tripple pulley



231424

Replacing A628T19970
Servicing A2T16677, -19777, -19877,
 -45272A, A3T33977
 Fan: O.D. 139 mm
 Pulley: O.D. 74 mm, Bore 15 mm



133344

Replacing A630D70401
Servicing A1T40191, -40291
 O.D. 57.1 mm, Bore 15 mm, W. 21.4 mm,
 3 grooves



139273

Replacing A628T24370
Servicing A2T24371, -24971, -25071
 Fan: O.D. 133 mm,
 Pulley: O.D. 68 mm, Bore 15 mm,
 Fan and single pulley



131204

Replacing A628T20670, -56470 
Servicing A3T32872, -33272
 O.D. 72.7 mm, Bore 15 mm, W. 20.6 mm,
 Single



133345

Replacing A679C01670, -02570
Servicing A1T01991, -02592, -40791,
 -40891, A2T00991, -03691, -03892
 O.D. 54.2 mm, Bore 15 mm, W. 25.5 mm,
 4 grooves



139984

Replacing A628T55670
Servicing A2T01384, -02084, -06384,
 -09884
 Fan: O.D. 138 mm
 Pulley: O.D. 93 mm, Bore 17 mm,
 Fan and single pulley



132833

Replacing A628C02070, -02170
Servicing A2T34391, -41091, -44991,
 -45091, -46591, -47891
 O.D. 54.8 mm, Bore 15 mm, W. 24.7 mm,
 5 grooves



133346

Servicing A4T25191, -25199, -30399
 O.D. 66 mm, Bore 15 mm, W. 30.6 mm,
 Double

Also see Pulley Survey
page 909

Replacing MITSUBISHI



133348

Replacing A679C00670
Servicing A2T48298
O.D. 62.6/60.3 mm, Bore 17 mm,
W. 47.7 mm, 4/6 grooves



133698

Servicing A2T08577
O.D. 69.4 mm, Bore 15 mm, W. 25.5 mm,
Single



134860

Servicing A3T03298, -45298
O.D. 62.6 mm, Bore 15 mm, W. 25.6 mm,
5 grooves



133460

Servicing A2T26391, -27091,
A3T03291, -45291
O.D. 56 mm, Bore 15 mm, W. 22.1 mm,
4 grooves



133868

Replacing A679C03370
Servicing A5T01897, -22997B
O.D. 48.5 mm, Bore 15 mm, W. 20.7 mm,
3 grooves



135272

Replacing A628T61270
Servicing A2T34477, -35177, A5T03677
O.D. 73.4 mm, Bore 17 mm,
Single, B-belt type



133623

Replacing A679C14270
Servicing A2T33191
O.D. 54.9 mm, Bore 17 mm, W. 24.9 mm,
4 grooves



134711

Replacing A628T49870, MD611260
Servicing A2T02577, -02977, -04277
O.D. 73.6 mm, Bore 15 mm,
Single, B-belt type



135424

Replacing A679C05570, MD 611835
Servicing A3T03392, -03393, -03493
O.D. 64.8 mm, Bore 15 mm, W. 21 mm,
4 grooves



133690

Replacing A679C04470
Servicing A2T05892
O.D. 59.9 mm, Bore 15 mm, W. 24.9 mm,
3 grooves



134712

Replacing A628T50570, MD611264
Servicing A2T02271, -02471, -02671,
-02771, -02871, -02971, -03171, -03471
O.D. 67.8 mm, Bore 15 mm,
Single



135454

Servicing A2T14591, -28792
O.D. 60 mm, Bore 17 mm, W. 32.5 mm,
6 grooves

Replacing MITSUBISHI

Also see Pulley Survey page 809



135559

Servicing A3T03292, A3T45292,
Citroen, Peugeot
O.D. 63 mm, Bore 15 mm, W. 22.2 mm,
4 grooves



135629

Replacing A679C00170
Servicing A2T42599A, -45799A
O.D. 69/74 mm, Bore 15 mm, W. 32.8 mm,
Double



136608

Servicing A2T14592, A2TA2292
O.D. 60.1 mm, Bore 17 mm, W. 28.6 mm,
5 grooves



135585

Replacing A679C14970
Servicing A5T04392A, -04492, -04492A,
-04492B
O.D. 59.5 mm, Bore 15 mm, W. 22.4 mm,
4 grooves



135743

Servicing A2T34598B,
Citroen, Peugeot
O.D. 62.9 mm, Bore 17 mm, W. 32.6 mm,
5 grooves



136676

Replacing A630D19370
Servicing A7T01474, -2171, 2171A,
-02874
O.D. 62.1 mm, Bore 17 mm, W. 16 mm,
Single



135594

Replacing A628T57370, MD618298
Servicing A1T04072, -04172, -04272,
-04572
O.D. 72.3 mm, Bore 15 mm, Single



136039

Replacing A679C09370, A679C14070
Servicing A3T08491, A4T00891D
O.D. 55.3 mm, Bore 17 mm, W. 25.1 mm,
5 grooves



136941

Replacing A679C12670, B3C7-18-W10
Servicing A2T33991, A2T39391,
A5T04092, -06291
O.D. 55 mm, Bore 17 mm, W. 23.6 mm,
4 grooves



135595

Replacing A679C00370
Servicing A2T02394, -B, -14694, -14794,
-B, -48594, -B, -C, -49094B
O.D. 68.9 mm, Bore 15 mm, W. 20.5 mm,
4 grooves



136041

Replacing A679C05470, MD611779
Servicing A2T09493
O.D. 64.7 mm, Bore 15 mm, W. 24.2 mm,
4 grooves



136953

Replacing A679C04570, RFG1-18-W11
Servicing A3T01871, -01872, -01877,
-01877A, -01877B, -04177
O.D. 72.2 mm, Bore 17 mm, W. 26.7 mm,
Single, B-belt type

Also see Pulley Survey
page 909

Replacing MITSUBISHI



136954

Replacing A628T59970, RF71-18-W15B
Servicing A3T01871, -01872, -01877,
-01877A, -01877B
For compressor
O.D. 104.5 mm, Bore 15 mm, W. 37.6 mm,
Single



136955

Replacing A679C12070, RFG1-18-W11
Servicing A2T36478, -36578, -36578A,
A2TN0678, A3T01877B, -04178
O.D. 81.8 mm, Bore 17 mm, W. 26.2 mm,
Single



136956

Replacing A628T62770, RFG1-18-W15
Servicing A2T36478, A2TN0678, -0684
For compressor
O.D. 100 mm, Bore 15 mm, W. 38.8 mm,
5 grooves



137433

Replacing A679C06570
Servicing A3T03099
O.D. 88 mm, Bore 17 mm, W. 37.2 mm,
Double, B-belt type



137551

Replacing A628T63470
Servicing A3T07483, -07983, -08083
O.D. 83 mm, Bore 17 mm,
Single, C-belt type



137552

Replacing A628X63670
Servicing A3T11278, -11678
O.D. 83.1 mm, Bore 17 mm,
Single, B-belt type



137553

Replacing A679C03170
Servicing A3T00599, -04999, -05499,
-06099, -07399
O.D. 83.4 mm, Bore 17 mm, W. 36.6 mm,
Double



137554

Replacing A679C10070, MD618341
Servicing A4T01493, -01793, -01893
O.D. 64.8 mm, Bore 17 mm, W. 25.1 mm,
6 grooves



137702

Servicing A4T01591
Ford
O.D. 55.1 mm, Bore 17 mm, W. 29.6 mm,
6 grooves



137844

Replacing A630C81870, MD618753
Servicing A2T38391, -39891, -80591,
-81791, A3TA0491, -0991
O.D. 63.2 mm, Bore 17 mm, W. 23.6 mm,
4 grooves



137958

Servicing A2T34591
O.D. 56.5 mm, Bore 17 mm, W. 28.2 mm,
4 grooves



137960

Servicing A2T82091
O.D. 52.1 mm, Bore 17 mm, W. 30.3 mm,
6 grooves

Replacing MITSUBISHI

Also see Pulley Survey page 809



137963

Replacing A630X86870
Servicing A2T81891, A2TA2591
 O.D. 55 mm, Bore 17 mm, W. 35.1 mm,
 6 grooves



137964

Servicing A2TA2091, -D, -E, -F, A3TA0591
 O.D. 56.5 mm, Bore 17 mm, W. 34.1 mm,
 6 grooves



138395

Replacing A679C14470
Servicing A2T36291, -38891, -39991,
 A2TA3491
 O.D. 64.9 mm, Bore 17 mm, W. 22.7 mm,
 4 grooves



138624

Replacing A629X50470, MD618921
Servicing A2T82899, A2TN0199, -0299,
 -0399, -0499, -0599, -1299, A3T15099
 O.D. 77 mm, Bore 17 mm, W. 36.4 mm,
 Double



138658

Servicing A3TA0593, A4T02893, -03293
 O.D. 62.93 mm, Bore 17 mm, W. 25.7 mm,
 5 grooves



139191

Replacing A630C82070
Servicing A2T35791, -35791A
 O.D. 66.5 mm, Bore 17 mm, W. 25.2 mm,
 6 grooves



139324

Replacing A679C13970
Servicing A5T06391
 O.D. 61.3 mm, Bore 17 mm, W. 22.9 mm,
 4 grooves



139346

Replacing A679C14170
Servicing A2T34892, -34992, -35092,
 -83291, A2TA5991
 O.D. 60 mm, Bore 17 mm, W. 22.6 mm,
 4 grooves



139348

Replacing A679X04070, MD618834
Servicing A2T07292, -A
 O.D. 60.1 mm, Bore 15 mm, W. 26.3 mm,
 4 grooves



139947

Replacing A628T59070
Servicing A2T17574, -18874, A3T04674,
 -05274
 O.D. 62.1 mm, Bore 15 mm, Single



230037

Replacing A628T62170
Servicing A1T24371, A7T02071,
 -02071A, -03171, -03171A, -03571,
 -03771, -03771A, A7TA0171, -8271
 O.D. 67.8 mm, Bore 17 mm, Single



230139

Replacing A679C07770
Servicing A1T03292, -03392
 O.D. 60 mm, Bore 15 mm, W. 21.9 mm,
 4 grooves

Also see Pulley Survey
page 909

Replacing MITSUBISHI



230309

Replacing F-230147
Servicing A2TB6481, A2TC0981
O.D. 56 mm, Bore 17 mm, W. 37 mm,
5 grooves, w/ Free wheel
Pulley tool: Cargo 210843



230505

Replacing A679C06670
Servicing A3T04582, -76182, -76682,
A4T04582
O.D. 88.4 mm, Bore 17 mm, W. 25.6 mm,
Single, C-belt type



230953

Replacing A630C80270
Servicing A2T37291, -37391, -37391A,
-39091, A2TA7591, -7691, A2TB1591,
-3091
O.D. 54.8 mm, Bore 17 mm, W. 33.6 mm,
5 grooves



230341

Replacing A679C03270
Servicing A2T46395B, -48195B,
A5T40195B
O.D. 73.8 mm, Bore 15 mm, W. 24 mm,
4 grooves



230534

Servicing A3T01498, -01596, -01598
O.D. 54.1 mm, Bore 15 mm, W. 33 mm,
6 grooves



230957

Replacing A679C02970
Servicing A1T01591, -01691, -02091,
-02191, -02291, -04691, -04791, -41291
O.D. 57.5 mm, Bore 15 mm, W. 20.3 mm,
3 grooves



230370

Replacing A679C00470
Servicing A2T46395, -48195A, A5T40195
O.D. 73.4 mm, Bore 15 mm, W. 24.9 mm,
4 grooves



230791

Replacing A629X51570, ME701549
Servicing A2TA3098, A3T09198, -9698,
-9698A, -9798A, A3TA3098, -3098A,
-4298, -4298A, -6098, -6098A
O.D. 71.5 mm, Bore 17 mm, W. 33.3 mm
Double



230958

Replacing A630X86970, -88270
Servicing A2TA5191, -5291, -5394,
-5492, A2TB5091
O.D. 59.7 mm, Bore 17 mm, W. 26.2 mm,
5 grooves



230504

Replacing A629X50370
Servicing A2T82378
O.D. 83.6 mm, Bore 17 mm, W. 30.7 mm,
Single, B-belt type



230792

Replacing A629X52470
Servicing A2TA1099, -1099A, -6099,
-6099A
O.D. 83.9 mm, Bore 17 mm, W. 36.7 mm
Double, B-belt type



231112

Servicing A2TA0291B, -C, -D
O.D. 56.1 mm, Bore 17 mm, W. 33.5 mm,
6 grooves

Replacing MITSUBISHI

Also see Pulley Survey page 809



231113

Replacing A679C08870, -13870
Servicing A2T09591
 O.D. 55 mm, Bore 17 mm, W. 31.6 mm,
 5 grooves



231672

Replacing A630C83470, MD618817
Servicing A3T11591, -13091, -13291,
 -13291A, -13291B, -14491, A3TA0791,
 -0791A, -1191, -1191A, -7591
 O.D. 65 mm, Bore 17 mm, W. 23.4 mm,
 5 grooves



232158

Servicing A2TA3791, -7491
 O.D. 58.1 mm, Bore 17 mm, W. 26.2 mm,
 6 grooves



231119

Replacing A630X88470, -92670
Servicing A2T82419B, A2TA4092A,
 -4092B, A2TB0491, -4091B, -3691, -3891,
 -4491
 O.D. 65 mm, Bore 17 mm, W. 30.4 mm,
 6 grooves



232155

Servicing A4T00796
 O.D. 54.3 mm, Bore 17 mm, W. 38.1 mm,
 8 grooves



232334

Servicing A2T37691
 O.D. 55.8 mm, Bore 17 mm, W. 29.1 mm,
 6 grooves



231284

Servicing A2T13391
 O.D. 56.4 mm, Bore 17 mm, W. 23.5 mm,
 5 grooves



232156

Servicing A6T41491, -41591
 O.D. 58.3 mm, Bore 17 mm, W. 27.4 mm,
 6 grooves



232354

Replacing A629X53870
Servicing A2TN1798, -1798ZT,
 MD340419
 O.D. 71.9 mm, Bore 17 mm, W. 36.7 mm,
 Double



231671

Replacing A629X52270
Servicing A3TA2799, -2799A, -4399
 O.D. 88 mm, Bore 17 mm, W. 37.9 mm
 Double, B-belt type



232157

Servicing A2T81192, A2TA2191,
 A2TB1491
 O.D. 66.8 mm, Bore 17 mm, W. 23.1 mm,
 4 grooves



233538

Servicing A3TA5591, -5591A
 O.D. 62.4 mm, Bore 17 mm, W. 33.9 mm,
 6 grooves

Also see Pulley Survey
page 909

Replacing MITSUBISHI



233610

Replacing A679C04970
Servicing A5T00192, -03092, -03192
O.D. 59.6 mm, Bore 15 mm, W. 23.3 mm,
4 grooves



234116

Replacing A630X92570
Servicing A2T38091, A3T13691,
-13691A, -13691B, A3TB0091, -4291
O.D. 59.6 mm, Bore 17 mm, W. 31.2 mm,
6 grooves



235039

Servicing A1TA2293 
O.D. 60 mm, Bore 17 mm, W. 27 mm,
3 grooves



234028

Replacing A629X50270
Servicing A3T09699
O.D. 84 mm, Bore 17 mm, W. 34.5 mm,
Double



234155

Servicing A4TA0094B
O.D. 62.6 mm, Bore 17 mm, W. 32.7 mm,
6 grooves



235071

Replacing A628X91871 
Servicing A3TA6581A
O.D. 85.5 mm, Bore 17 mm, W. 34.2 mm,
W/ Free wheel
Single, B-belt type



234029

Replacing A629X54670
Servicing A2TB1298
O.D. 92 mm, Bore 17 mm, W. 36.7 mm,
Double



234867

Replacing A628X91371, F-229974.1 
Servicing A2TB1081A
O.D. 65 mm, Bore 17 mm, W. 38.7 mm,
6 grooves, w/ Free wheel
Pulley tool: Cargo 210843



235228

Servicing A1TA3392A, -C, A5TA6292C, 
-F, G, A5TA6392C, A5TA7692, A5TA7792
O.D. 49 mm, Bore 17 mm, W. 30.5 mm,
6 grooves



234096

Replacing A628X64770, -65570
Servicing A2T37976, A2TN0076, -2476
O.D. 78.5 mm, Bore 17 mm, W. 21.6 mm,
Single



234897

Replacing A630X83870, MD618930 
Servicing A2T83592, A2TA2691, -3091,
-4391, -4991, -5391, -5692, -5692A, -5491,
A3TA3391, -5491, A3TB0291, -0391, -4191
O.D. 59 mm, Bore 17 mm, W. 23.6 mm,
4 grooves



238068

Replacing F-236001 
Servicing A3TB4981
O.D. 60 mm, Bore 17 mm, W. 39 mm,
8 grooves, w/ Free wheel
Pulley tool: Cargo 210843

Replacing MITSUBISHI



210843

Tool to be used for mounting and dismounting of free wheel pulleys
Shaft L. 74 mm.

210948

As Cargo 210843, but
Shaft L. 114 mm.

Fan & Pulley Parts



134273 Std pkg 10 A

O.D. 21.6 mm, Bore 15.5 mm, Th. 5.9 mm
Spacer



136238 Std pkg 5

O.D. 22 mm, Bore 17 mm, Th. 9 mm
Spacer



233341 Std pkg 5

O.D. 47 mm, Bore 15 mm, Th. 14 mm
Spacer
Used w/ pulley: Cargo 132835, 133345

Vacuum Pumps



230136

Replacing A595T03970, -04070
Servicing A2T01384, -01483, -01583, -01683, -01783, -06384, A3T00599
8 splines



230141

Replacing A595T03670
Servicing A3T35278A, -35299A
8 splines



230162

Replacing A595T01770, MD607874
Servicing A2T41477, A3T35577
8 splines



231313

Replacing A595T05870, -05970
Servicing A2T14376, -14876
8 splines



231438

Replacing A595X30170, -30470
Servicing A2T82899, A2TN0299, -1199, -1199AT, -1798, -1798A, A3T15099, A3TN0699
8 splines



231439

Replacing A595X20570, MD619043
Servicing A2TN0399, A3TN0399
8 splines

Replacing MITSUBISHI

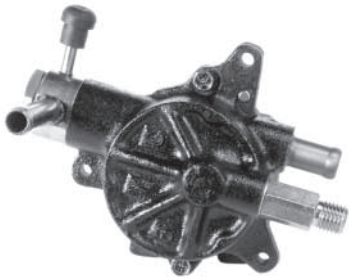

231492

Replacing A595T00170, -00870, -01470
Servicing A2T27477, -27477A, -32077, -40484, -43583, A5T15684, -15784, -15884, -16384, -20484, -21684, -21984, -21984B, -23784
 8 splines



232232

Replacing A595T05770
Servicing A3T03099
 8 splines



232427

Replacing A595T07470
Servicing A2T17783, -27883
 8 splines

235037

Servicing A3TN1791
 8 splines



Vacuum Pump Parts



136685

Replacing A882C90970, ME700957
Servicing A2T27883, A3T04582, -04999
 O.D. 58.8 mm, W. 33 mm, 8 splines
 Rotor
Vane set: Cargo 133962



136686

Replacing A882C90101, MD607625
Servicing A1T33076, -33576, -33676
 O.D. 48.8 mm, W. 24.1 mm, 8 splines
 Rotor
Vane set: Cargo 133585



136687

Replacing A882C90501, ME700565
Servicing A2T01483, -01583, -01683
 O.D. 48.8 mm, W. 28 mm, 8 splines
 Rotor
Vane set: Cargo 133280



230460

Replacing A882C23901
Servicing A2T25377, -25578, -25584, -25598, -71978, A3T33684, -33698
 O.D. 48.8 mm, W. 28 mm, 8 splines
 Rotor
Vane set: Cargo 133280

Replacing MITSUBISHI

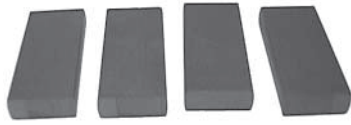

133280 A

Replacing A990D01101
4.95 x 12.6 x 27.95 mm
Rotor vane set



135133 A

Replacing A584X01970
Servicing A2T08799, -41599, -47299
M18-1.5
Valve set
Rubber seal: Cargo 231522



080255 Std pkg 10 A

M14-1.5
Hollow screw



133585 A

Replacing A990D01401, MD607626
5 x 15.1 x 24 mm
Rotor vane set



135134 A

Replacing A584X02671, MD607753
Servicing A2T01384, -01483, -01583, -43583, A5T15684
M18-1.5
Valve set
Rubber seal: Cargo 231522



230318

Replacing A584X00578
Servicing A2T25377, -25578, -25584, -25598, A3T33684, -33698
M18 x 41 mm
Hollow screw w/ valve



133962 A

Replacing A990D01901, ME700944
Servicing A2T19983, -27883, -72378
4.9 x 17.6 x 33 mm
Rotor vane set



136663

Replacing A584X04971, ME700955
Servicing A5T70283, A6T75286, -75586
M18/20
Valve



137046 A

Replacing A361X05271
Servicing A1T33576, -33676, -71076
M10-1.25 / M12-1.50
Vacuum pump connector kit



135132 A

Replacing A584X04371
Servicing A2T07677, -28976, -32277
M18-1.5
Valve set
Rubber seal: Cargo 231522



080252 Std pkg 10 A

M10-1
Hollow screw



134290 Std pkg 10 A

M12-1.5
Screw plug

Also see O-ring Survey
and Oil Seal Survey

Replacing MITSUBISHI

Repair Kits



233342

Servicing A3T01596, -01598
B+ terminal M5 x 41.5 mm
w/ 6.5 mm KNURL O.D.
Terminal kit

Sundry Parts



132662 A

Replacing A351X90571
Servicing A2T01384, -01077
14.8 x 30 x 5 mm
Oil seal kit



132663 A

Replacing A351X90471
Servicing A2T41599
11.5 x 25.4 x 4.5 mm, 11.5 x 25.4 x 5.0 mm
Oil seal kit



132664 A

Replacing A351X90371, 0636-24-414
Servicing A2T11173, AP2030F
14 x 30.2 x 4.5 mm, 14 x 30.3 x 5 mm
Oil seal kit



133092 Std pkg 5 A

Replacing A450X16371
Servicing A2T13571, -47974, A5T30871
L. 50.8 mm
B+ Terminal M5

133598 Std pkg 5 A
Replacing S809P59201, ME700564
72 x 2 mm
O-ring



134482 Std pkg 10 A
Replacing S809P58470, MD607675
16 x 2.5 mm
O-ring



Replacing MITSUBISHI



133093 Std pkg 5 **A**
Replacing A450X17471
Servicing A2T05772
 L. 52 mm
 B+ Terminal M6



135957 Std pkg 5 **A**
Servicing A2T34598
 L. 44 mm
 B+ Terminal



136551
Replacing A450X17871
Servicing A2T75076, -75476, A3T01877, -01877A, -01877B, -04178, -04199, -76276
 L. 51 mm
 B+ Terminal M6



133251
 Part for A450X16271, Cargo 137842
 L. 60 mm
 B+ Terminal M6



136316 Std pkg 5
Servicing A3T01596, -01598
 B+ Terminal



137209
Replacing A450X17571
Servicing A1T01571, -01691, -02091, -02191, -02291, -04691, -04791, -04892
 L. 50.5 mm
 B+ Terminal M6



133560 Std pkg 5 **A**
Servicing A2T25171, -26172, -41191
 Terminal



136421
Replacing A450X21871
Servicing A2T33191
 L. 90 mm
 B+ Terminal M8



137842
Replacing A450X16271
Servicing A2T48292, -48298
 L. 60 mm
 B+ Terminal M6
Terminal only: Cargo 133251



135371
Replacing A450T21371
Servicing A3T08491
 L. 92 mm
 B+ Terminal M8



136550
Replacing A450X22671
Servicing A2T36478
 L. 54 mm
 B+ Terminal M6



138629
Replacing A450X20771
Servicing A2T35791, -35791A, A3T09591
 L. 55 mm
 B+ Terminal M8

Replacing MITSUBISHI



138630
Replacing A450X19871
Servicing A2T17574, -18874, A3T06291
 L. 70 mm
 B+ Terminal M8



135880 Std pkg 5
Servicing A2T32692
 Ford
 L. 108 mm
 B+ Terminal M6
 Terminal block



234069
Servicing A5TA6291, -6291A, -6291C,
 -6391, -6391B, -6391C, -6392C
 B+ terminal M8
 Terminal block



139189
Replacing A450X23471
Servicing A2T39291, -39391, -A, -80391,
 -83491, -A, -83591, A2TA0791, -3991,
 L. 55 mm
 B+ Terminal M8



139364
Servicing A2TA1494, -1991, -D,
 -2091, -D, -E, -F, -2094, -B, -C, -D
 L. 138 mm
 B+ Terminal M8
 Terminal block



234110
Servicing A3TA6491, -6491A, A3TB0891,
 -0891A, -0891B
 B+ terminal M8
 D+ terminal M5
 Terminal block



139190
Replacing A450X23671
Servicing A2T82191, -82191A, -82191B
 L. 55 mm
 B+ Terminal M8



232464
Servicing A3TA5591A
 Terminal block



137843
Replacing A450X16871, -20871
Servicing A2T02271, -02471, -02571,
 -02671, -02771, -02871, -02977, -03171
 B+ Terminal
 Terminal set
B+ Insulator: Cargo 233306



234641
Servicing A2T43472, A3TA0399
 B+ terminal M6



233823
Servicing A2TB2291A, -4791, -4791A,
 -4791B, -4891A, -4891B
 B+ terminal M8
 D+ terminal M5
 Terminal block



231316
Replacing A450X09371
Servicing A1T03476, -23377, -25077,
 -25083, -31374, -32471, -33277, -70783,
 A2T23477, -24371, -24971, -31677
 Terminal set
B+ Insulator only: Cargo 233305

Replacing MITSUBISHI



231499
Replacing A450X16471
Servicing A2T07677, -07777, -08799,
 -41599A, -47299
 Terminal set



134999 A
 4P - 2P Coupler



134671 Std pkg 10 **A**
 Bore 6 mm, O.D. 21.7 mm
 Insulator



134719 Std pkg 5 **A**
 Repair plug



135000 A
 4P - 3P Coupler



135311 Std pkg 10
Servicing A2T17491, -37691, A4T00891,
 -00991, -02891, -02893, -03491
 Citroen, Peugeot
 B+ Insulator



133252 A
 Plug that converts early style
 alternator into late style w/ oval plug
 Coupler



232778 Std pkg 5 **A**
 1P Coupler w/ lead wire (male)



233305 Std pkg 5
 I.D. 5 mm
 B+ Insulator
Part of terminal set: Cargo 231316



134996 A
 3P - 2P Coupler



135230
 Extension harness



233306 Std pkg 5
Servicing A1T03476, -23377, -25077,
 -25083, -31374, -32471, -33277, -70783,
 A2T23477, -24371, -24971, -31677
 I.D. 6 mm
 B+ Insulator
Part of terminal set: Cargo 137843

Replacing MITSUBISHI



233307 Std pkg 5
Servicing A2T81192, -81292, -81391, A2TA3791, A2TB1491, A3T14292
 I.D. 6 mm
 B+ Insulator



233340 Std pkg 5
 O.D. 22 mm, I.D. 9 mm
 Cover
Used w/ bearings: Cargo 140231, 140232, 140234, 140419



138912
Replacing A529X06471
Servicing A1T06291, A1TA0191, A2T04377, -4577, -4577X, -4578, -4598
 6.3 x 19-22 x 9.1 mm
 M6
 Nut set



135312 Std pkg 10
Servicing A2T17491, -37691, A4T00891, -00991, -02891, -02893, -03491
 Citroen, Peugeot
 D+ Insulator



138194
Replacing A529X07671, MD611480
Servicing A2T01483, -01583, -01683
 B+ terminal M6
 Nut set



231500
Replacing A529X06071
Servicing A1T32084, -32099, -32176, -33076, -33576, -33676, -70676, -71076, -71176, -71276, -71576, A2T01976, -08799, -25979, -27176, -27376, -27477
 Nut set



134718 Std pkg 5 **A**
Servicing I.C. alternators w/ internal fan
 Cover for slip ring



138626
Replacing A529X08971, MD618807
Servicing A1T06672, A2T18177, -18277, -38391, -80591, -81791, -82899, A2TA0891
 B+ terminal M8
 Nut set



231501
Replacing A529X11371
Servicing A2T33593B, -33593C, -33593E, -37791C, -81991, -82191C, A2TA2991, -2991A, -3891A, -3891B, -4578
 B+ terminal M8
 Nut set



137208
Servicing Cargo 133004, 134026, 134088, 134344,
 Cover for slip ring



138869
Replacing A529X10571, MD618749
Servicing A1T06391, -06791, -06891, A2TA0091, -0291, -0491, -0591, -0691
 B+ terminal M8
 Nut set



234572
Servicing A2TB6481
 B+ terminal M8
 Nut set

Replacing MITSUBISHI



138868

Replacing A414X19371, MD611558
M5 x 15 mm
Screw set



191539 Std pkg 100

Replacing A414X12771
M5 x 75 mm, 25 mm thread
Thru bolt



231522 Std pkg 10

Servicing A584X01970, -02671, -04371,
Cargo 135132, 135133, 135134
18 x 21 x 3 mm
Rubber seal



232438 Std pkg 10

14 x 27 x 2 mm
Washer

Replacing MOTOROLA Eur.

Rotors



131942
Replacing 512-039
Servicing 9AR2659K, -2673K, -2760K, -2897L
 12 V. 55 Amp.
 L. 147 mm, O.D. 88.5 mm, Shaft 17 mm

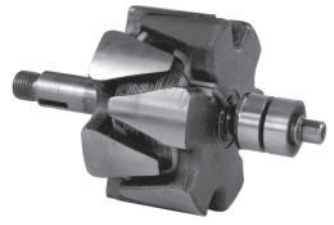

131964
Replacing 512-081
Servicing 9AR2970, -5044, -5081, -5084
 12 V. 65 Amp.
 L. 150 mm, O.D. 88 mm, Shaft 17 mm



138827
Replacing 512-030
Servicing 9AL2633G, -2696G, -2762G, -2765G, -2774G, -2817G, -2969F
 12 V. 28 Amp.
 L. 145 mm, O.D. 82.4 mm, Shaft 17 mm



131962
Replacing 2523324
Servicing 2940363, 2940367
 12 V. 65 Amp.
 L. 150.3 mm, O.D. 88.3 mm, Shaft 17 mm



136583
Replacing 512-015
Servicing 2940020, -753, -926, -928, 9AL3580G, -3581G, -3586G, -3776G, -3911G, -3925G, -3926G, -3955G, -3956G
 24V. 40 Amp.
 L. 147 mm, O.D. 88.5 mm, Shaft 17 mm

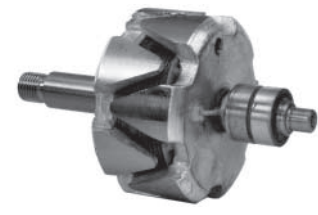

138828
Replacing 512-031, -041
Servicing 9AL2666F, 9AR2610G, -2627G, -2636G, -2641G, -2642G, -2650D, -2651D, -2652F, -2653F, -2654G, -2655G, -2662F
 12 V. 35/45 Amp.
 L. 144.7 mm, O.D. 82.4 mm, Shaft 17 mm



131963
Replacing 2523331
Servicing 2940371, 2940375
 12 V. 65 Amp.
 L. 172 mm, O.D. 90 mm, Shaft 17 mm



137525
Replacing 512-004, -005, -028, -029,
Servicing 9AL2505P, -2512P, 9AR2533P, -2605L, -2607P, -2628P, -2637P, -2638P, -2661P, -2672P, -2684P, -2690P, -2710P
 12 V. 75 Amp.
 L. 147 mm, O.D. 88.4 mm, Shaft 17 mm

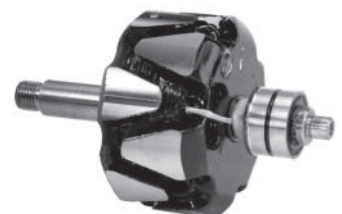

138829
Replacing 512-067
Servicing 9AL6027K, 9AR2631L, -3802L, -3825L, -3949K, -6015K, -6025K, -6053L, -6057L, -6058L, -6093K
 24 V. 55 Amp.
 L. 152.5 mm, O.D. 88.5 mm, Shaft 17 mm

Replacing MOTOROLA Eur.

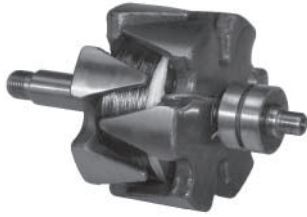

139743

Replacing 512-025
Servicing 2518073, -074, 2541129, -139, -154, -300, 2940077, -130, -357, -361, -377, -384, -717, 9AR2671T, -2674T
 12 V. 90 Amp.
 L. 152 mm, O.D. 88.4 mm, Shaft 17 mm

Rotor Parts



139039 Std pkg 5

Replacing 520-061
 O.D. 25 mm, Bore 17 mm, Th. 5.3 mm
 Rotor spacer

Stators



131979

Replacing 2523329
Servicing 2940363, 2940367, 2940371, 2940375
 12 V. 65 Amp.
 O.D. 127 mm, I.D. 89.4 mm, W. 25.2 mm



131980

Replacing 513-013, 592625
Servicing 2541130, -131, -148, -198, -290, 2940034, -119, -148, -208, -347, -349, -351, -359, 2941123, -232, -253
 12 V. 75 Amp.
 O.D. 133 mm, I.D. 88.6 mm, W. 27.5 mm



132374

Replacing 513-016, -017, -032
Servicing 2940087, 2940137, 2940138, 2940139, 2940140, 2940173, 2940409, 2940813, 2940861, 2940930, 2941095
 12 V. 40 / 45 Amp.
 O.D. 122.7 mm, I.D. 82.8 mm, W. 23.6 mm

Replacing MOTOROLA Eur.



136363

Replacing 513-007
Servicing 2940020, -413, -414, -753, -926, -928, 9AL3544G, -3580G, -3581G, -3586G, -3776G, -3911G, -3925G
 24 V. 40 Amp.
 O.D. 133 mm, I.D. 88.5 mm, W. 27.2 mm



139659

Replacing 592629
Servicing 2541139, -154, -300, 2940077, -130, -356, -357, -361, -377, -384, -717, 9AR2624U, -2671T, -2674T, -2731R
 12 V. 90 Amp.
 O.D. 132.9 mm, I.D. 88.5 mm, W. 30.8 mm



230688

Replacing 513-015, -033
Servicing 2541423, 2940060, -776, -778, -780, -782, 9AL6027K, -6027K01, 9AR3802L, -3825L, -3949K, -3949K01
 12 V. 65 Amp.
 O.D. 133 mm, I.D. 88.4 mm, W. 30.6 mm

Brackets D.E.



138191

Replacing 514-004
Servicing 9AR2500K, -2506K, -2524F, -2615G, 2622L, -2638P, -2780K, -2810L, -2838L, -2867L, -3599G, -5047, 510-020, -094, -108, -115, -123, -237, -255, -256
Bearing: Cargo 140087

Bracket Parts



134781 Std pkg 10 **A**
Replacing 511-010
 Bearing retainer



139582
Replacing 518-006
Servicing 2518057, 9AR2964
 Mounting bracket



130903 Std pkg 5 **A**
Servicing 6200
 O.D. 33 mm, I.D. 30 mm, W.13.25 mm
 Bearing cap, S.R.E.



131605 **A**
Servicing 9AL 2505P, 9AR 2730P, -2731P, -2872P
 M10
 Bracket mounting bushing kit

Replacing MOTOROLA Eur.

Covers

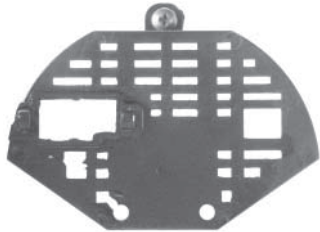

131139

Replacing 514-083
Servicing 9AR2701, -2702, -2703, -2704, -2705, -2706, -2819, -2820, -2843, -2890, -2895, -2913, -2929, -2895FO2, -2895FO3



131617

Replacing 514-115
Servicing 9AR2659G, -2660K, -2695K, -2760K, -2934K, -2936P, -5042P

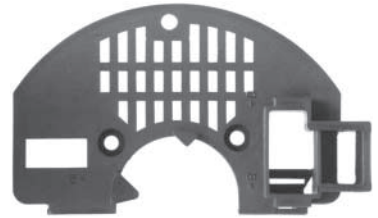

132235

Replacing 514-267
Servicing 9AR2748K, -2785K, -5028K

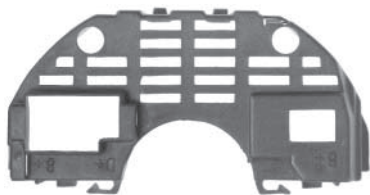

131213

Replacing 514-080
Servicing 9AR2726G, -2727, -2727G, -2839, -2839G, -2896, -2896G, -2926



132233

Replacing 514-005
Servicing 9AR2501K, -2502K, -2510K, -2538K, -2512P, -2533P, -2513F, -2514F, 9AL 2505P, -2707G, -2540G



132602

Servicing 2940303, 2940304, 2940305 A, 2940308



131230

Replacing 514-001
Servicing 9AR2524, -2525, -2526, -2527, -2528, -2622, -2763, -2764, -2830, -2833, -2897, -2919, -2920, -5036

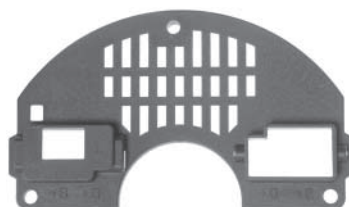

132234

Replacing 514-027
Servicing 9AR2539K, -2545K, -2561K, -2562K, -2569G, -2570G, -2594G, -2614G, -2615G, -2629G, -2602F, -2603F, -2611F, -2613F, -2612G



134657

Replacing 514-12
Servicing 9AL2505P, -2628P, -2885K, 9AR2730P, -2872P, -5097P, 2541423, 2940275

Replacing MOTOROLA Eur.

Regulators



130574

Replacing 505-034, 9RC 7045
Servicing 9AR2810P, -2712P
 12 V.



130613

Replacing 505-053, 9RH7044
 12 V.



130974

Replacing 505-032, 9RC7042
Servicing 9AR2915, -2916, -2917, -2918
 12 V.



130575

Replacing 505-035, 9RC8085
Servicing 510-804, 9AR 3713
 24 V.



130849

Replacing 505-010, 9RC7004
Servicing 9AR 2506K
 12 V.



131066

Replacing 505-026, 9RC7030
Servicing 9AR2659K, -2660K, -2676K,
 -2676K, -2689K, -2695K, -2760K, -2778K,
 -2933P, -2934K, -2935P, -2936P
 12 V.



130610

Replacing 505-054, 9RH8043
 24 V.



130934

Replacing 505-017, 9RC8026
Servicing 290413, 290414, 290776
 9AR 3599, -3620, -3631, -3721, -3797,
 -3798, -3802, -3825, -3868, -6025, -6053,
 -6057, -6058
 24 V.

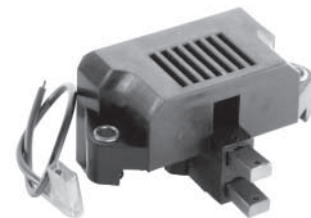

131224

Replacing 505-100, 9RC7104
Servicing 2541395, -396, -402, 2940359,
 -363, -365, -367, -369, -371, -373, -375,
 -409, 9AR2970K, -2971G, -2972G,
 -2973L, -2974L, -2975L, -2976K, -2977L
 12 V.

Replacing MOTOROLA Eur.



131225

Replacing 505-092, 9RC7078
Servicing 9AR 2870P, -5049K, -5055P
 12 V.



133125

Replacing 505-086, -090
Servicing 9AR2731R, -2874R, -5017R
 12 V.

Volt setting 15 V.



133669

Replacing 505-010, 9RC7004
Servicing 9AR2506K
 12 V.



132231

Replacing 505-085, 9RC7068
Servicing 9AR2730P, -2872P
 12 V.

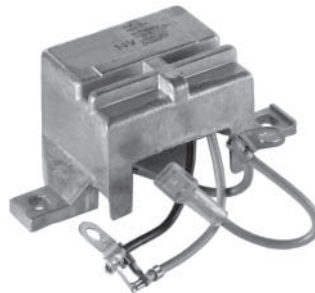

133133

Replacing 505-088, -079
Servicing 9AR2958G
 12 V.

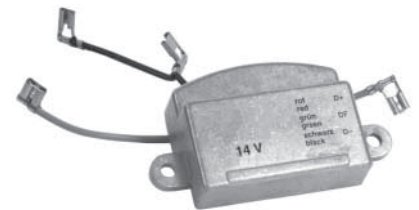

231421

Replacing 9RC7052, -7054, 505-037, -038
Servicing 9AR2732P, -2733P, -2734P,
 -2735P, -2736P, -2831P, -2854P, -2881P,
 -2923P, -2958P, -2999P, -5031P, -5080P
 12 V.



132232

Replacing 505-102, 9RC7102
Servicing 9AR 2964K, 5097P
 12 V.

Volt setting 15 V.



133664

Replacing 505-100, 9RC7 104
Servicing 9AL2977, 9AR5044K, -5099
 12 V.
 Same as Cargo 131224

Replacing MOTOROLA Eur.

Rectifiers



130980

Replacing 501-006
Servicing 9AR2561K, -2562K
 W/ diode trio

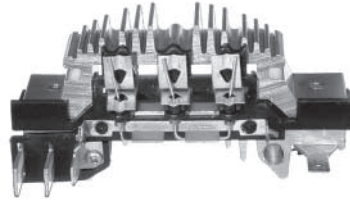

131135

Replacing 501-111
Servicing 9AR2525K, -2526K, -2527K, -2528F, -2763F, -2764L, -2830L, -2838L, -2897L, -2919P, -2920P
 W/ diode trio

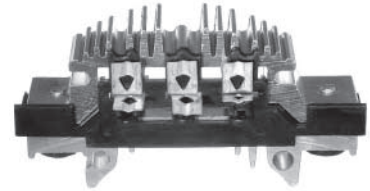

131697

Replacing 501-002
Servicing 9AL2502K, -2505P, -2559G, -2572K, -2577G, -2583K, -2584G, -2589K, -2590K, -2591K, -2592K, -2593K, -2600G
 W/o diode trio

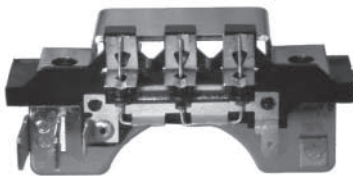

130981

Replacing 501-024
Servicing 9AR2915F, -2916F, -2917G, -2918G
 W/ diode trio



131565

Replacing 501-119
Servicing 9AR2659K, -2660K, -2675K, -2676K, -2695K, -2778K, -2934K, -2936P, -2933P, -2945P, -2948K, -2950P, -2996P,
 W/ negative poled diode trio

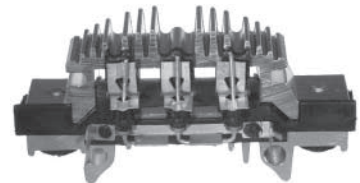

131698

Replacing 501-014, -056, -101
Servicing 9AL2582K, -2595K, -2607P, -2617K, -2658K, -2679K, -2685K, -2793P, -2885K, 9AR2638P, -2663K, -2672P
 W/ HD diode trio



130983

Replacing 501-054
Servicing 9AL2633G, 9AR2729G
 W/ diode trio

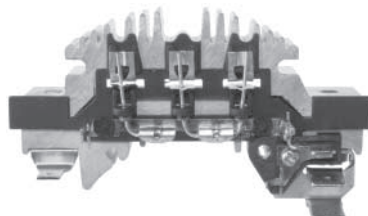

131566

Replacing 501-089
Servicing 9AR2970K, -2971G, -2972G, -2973G, -2974L, -2975L, -2976K, -2977L, -5081K, -5082G, -5083G, -5084L, -5085L, -5086L, -5087K, -5088L, -5089G, -5090L
 W/ diode trio

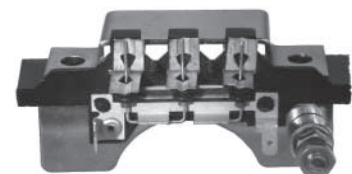

131699

Replacing 501-037
Servicing 9AL2969F, 9AR2682F, -2716G, -2717G, -2718G, -2719G, -2749G, -2750G, -2751G, -2799G, -2814D, -2821G, -2882F, -2887G
 W/ diode trio
 B+ terminal M6 x 14 mm

Replacing MOTOROLA Eur.

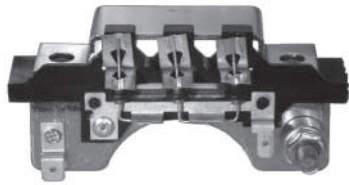

131700

Replacing 501-027
Servicing 9AR2662F, -2664F, -2748G, -2828G, -2829G, -2871G, -2875G
 W/ diode trio
 B+ terminal M6 x 14 mm

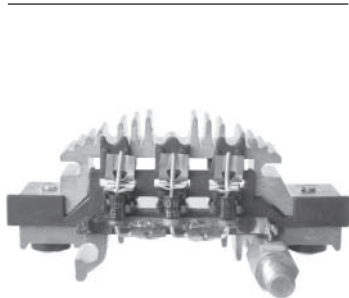

132673

Replacing 501-104
Servicing 510-262, -263, -475, -476, -477
 9AR3802L, -3835L, -6035L, -6057L, -6058L
 W/ diode trio
 B+ terminal M8 x 12 mm

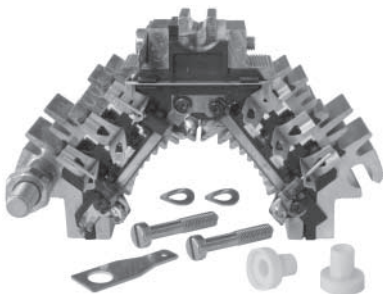

134707

Replacing 592651
Servicing 2541139, 2541154, 2541300, 2940130
 W/ diode trio
 B+ terminal M8 x 11 mm

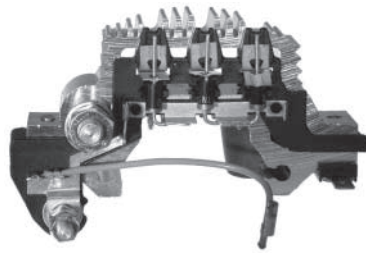

132938

Replacing 2523321
Servicing 2940300, 2940301, 2940302, 2940303, 2940304, 2940305, 2940306
 W/ diode trio
 B+ terminal M7 x 18 mm
 D+ terminal M5 x 16 mm

Diode Trios



132097 A

Replacing 1-129
Servicing 9BB , 9DA , 9FB

Replacing MOTOROLA Eur.

Slip Rings



131218 A

Replacing 512-003
O.D. 32 mm, Shaft 19 mm, L. 22.5 mm



131219 A

Replacing 512-055
O.D. 26 mm, Shaft 13.3 mm, L. 25 mm



131818 A

Replacing 512-004
O.D. 32 mm, Shaft 17 mm, L. 22.5 mm



133055 Std pkg 5 A

Servicing 2940304, 2940305, 2940307,
2940309, 2940311, 2940371, 2940374
O.D. 26.5 mm, Shaft 15 mm, L. 22.6 mm



231400

O.D. 26.5 mm, Shaft 13.3 mm, L. 22.6 mm

Brush Boxes

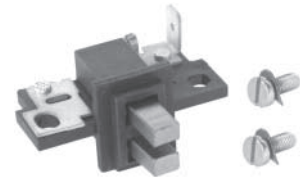

130933 A

Replacing 503-001, -005
Servicing 9AR2561K, -2562K, -2619,
-2741F, -2794, -2904, -3868G
Complete w/ brushes

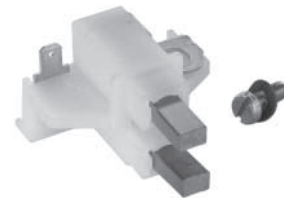

130976 A

Replacing 503-009
Servicing 9AR2610G, -2627G, -2698F,
-2799G, -2882FO1, -2918G, -2960F
Complete w/ brushes

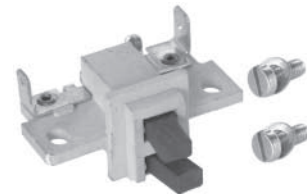

130979

Replacing 503-025
Servicing 9AR3713G
Complete w/ brushes

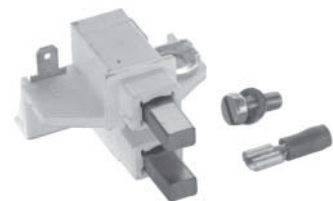

131060

Replacing 503-007
Servicing 9AL2633G
Complete w/ brushes

Replacing MOTOROLA Eur.

Also see Pulley Survey
page 809

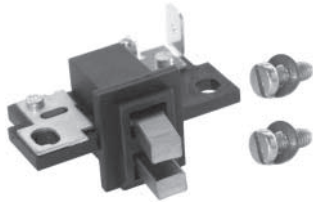

131092

Replacing 503-019
Servicing 9AL3921G, -5002K, -5051P,
9AR2567F, -2725F, -2963L, -3802L
Complete w/ brushes

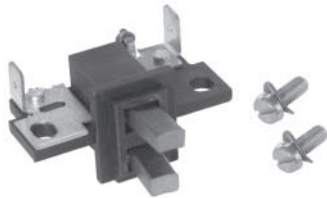

132317 A

Replacing 503-008
Servicing 9AL2615, -2618, -2688, -2940,
-2967, 9AR 2659, -2660, -2675, -2676
Complete w/ brushes

Brush Sets



MX1 2 Std pkg 10 A
4.5 x 6 x 14.5 mm
12/24 V.

Fan & Pulleys



131048

Replacing 507-088
O.D. 83.6 mm, Bore 17 mm
Single, B-type belt



231675

Replacing 507-008, -090, -106
Servicing 9AR2726G, -2763G, -2764G,
-5039L, -5044K, -5082G, -5083G, -5085L,
-5086L
O.D. 62.9 mm, Bore 17 mm, W. 19.9 mm
Single



232351

Servicing 9AR2746P, -2747P, -2854P,
-2958P, 510-859
O.D. 84 mm, Bore 17 mm, W. 17.1 mm
Single

Also see O-ring Survey
page 854

Replacing MOTOROLA Eur.

Sundry Parts



132237 A

Replacing 520-035

Servicing 9AL2507G, -2540G, -2560G,
-2578G, -2579G, -2582K, -2585G, -2595K
Terminal kit



139561 Std pkg 10

Replacing 511-004

30 x 2 mm
O-ring

Replacing MOTOROLA US

Rotors



135378

Replacing 112-49
Servicing 8SC3009, -3017, -3021
 24 V. 175 Amp.
 L. 229 mm, O.D. 125.7 mm, Shaft 22/25 mm



231436

Replacing 112-54
Servicing 8SC3014U, 110-298
 24 V. 100 Amp.
 L. 230 mm, O.D. 126 mm,
 Shaft 22.23 mm (7/8")



234398

Replacing 112-51
Servicing 8MR2035T, -2069T,
 110-244, -402
 12 V. 90 Amp.
 L. 155 mm, O.D. 88 mm, Shaft 5/8"

Rotor Parts



136911 Std pkg 5
Replacing 120-128
 5/8"-18
 Rotor shaft nut

Stators



131870 Reman.
Replacing 113-1
Servicing 8AL , 8AR ,
 8MA , 8HA , 8MR
 12 V. 35 Amp.
 O.D. 126.6 mm, I.D. 88.5 mm, W. 14.9 mm



131871 Reman.
Replacing 113-3
Servicing 8HA , 8AL , 8MA ,
 8AR , 8MR
 12 V. 55 Amp.
 O.D. 127.1 mm, I.D. 88.2 mm, W. 21.6 mm



133062
Replacing 113-46
Servicing 8LHA3025P, -3031P
 24 V. 75 Amp.
 O.D. 167.8 mm, I.D. 126.1 mm, W. 15.5 mm

Replacing MOTOROLA US



133063

Replacing 113-25
Servicing 8SC2001R, -3002U, -3003U, -3008U, -3011U, -3014U, -4006U
 24 V. 100 Amp.
 O.D. 167.6 mm, I.D. 126.2 mm, W. 32.5 mm



133064

Replacing 113-28
Servicing 8SC3005V, -3009Z
 24 V. 175 Amp.
 O.D. 167.5 mm, I.D. 125.9 mm, W. 32.5 mm



135070

Replacing 113-16
Servicing 8MA2003P, -2010P, -2013P, -2014P, -2018P, -2020P
 12 V. 72 Amp.
 O.D. 127 mm, I.D. 88.3 mm, W. 26 mm



234399

Replacing 113-40
Servicing 8MA2015T, 8MR2025T, -2027T, -2028T, -2030T, -2033T, -2035T, -2059T, -2069T, -2070T, -2071T
 12 V. 90 Amp.
 O.D. 127.1 mm, I.D. 88.5 mm, W. 26.2 mm

Brackets D.E.



232407

Replacing 14-90, 114-90
Servicing 8HA2003F, -2004G, -2005K, -2006F, -2008F, -2009K
 Bearing: Cargo 140219



232408

Replacing 14-1, 14-9, 114-1, 114-9
Servicing 12N37, -40, -51, 8AL2017F, -2018K, -2019F, -2022F, -2023G, -2071K, -2105L, -2106F, -2106FA, -2107K, -2109F, -2109FA, -2171K, 8AR2007, -2009
 Bearing: Cargo 140087



232409

Replacing 14-6, 14-37, 114-6, 114-37
Servicing 8AL2030L, 8AR2002, -2004, -2005, -2008, -2013L, -2015K, -2016K, -2021K, -2028F, -2044F, -2045K, -2048F, -2049K, -2050F, -2051K, -2060F, -2062K
 Bearing: Cargo 140087

Replacing MOTOROLA US

Also see Oil Seal Survey page 856

Brackets S.R.E.

Bracket Parts



232410

Replacing 14-55, 114-55
Servicing 8AL2048F, -2049K, -2055F, -2056K, -2067K, -2068F, -2069K, -2080K, 8MA2010P, -2013P, -2014P, -2015T, -2018P, A12NCC454, A12NFT600
Bearing: Cargo 140087



232411

Replacing 14-18, 114-18
Servicing 12N37, -N37A, -N40, -N51, -N51A, 8AL2001, -2002K, -2004F, -2005F, -2006F, -2007F, -2008K, -2009K, -2019F, -2020L, -2022F, -2023G, -2039K, -2071K,
Bearing: Cargo 140079



133065 A

Replacing 111-46, -54, -76
Servicing 8LHC2004Z, -2010Z, 8SC 2001R, -2004Z, -2007R, -2010Z
 O.D. 1.852"
 Oil seal



234688

Replacing 114-164
Servicing 8LHA2022R, -2023, -2023V, -2023VA, -2024R, -2024RA, -2024VA, -2040RA, -2041VA, -2063R, -3025, -3025P, -3025PA, -3071P
Bearing: Cargo 140279



133066

Replacing 111-5, -77
Servicing 8LHC2004Z, -2010Z
 O.D. 2.059"
 Oil seal



133067

Replacing 111-11
Servicing 8LHC , 8SC
 Gasket

Replacing MOTOROLA US

Regulators

Adjustable voltage



130570

Replacing 105-87, -150, 8RD203
Servicing 8AL2018K, -2024L, -2030L
 12 V.

Adjustable voltage



131178

Replacing 105-249, 8RG3032
Servicing 8LHA3025R, 10-296,
 Cargo 110173
 24 V. 75 Amp.

Adjustable voltage



131210

Replacing 105-226, 8RG2022
Servicing 10-252, 8MR2033T
 12 V.

Adjustable voltage



131166

Replacing 105-223, 8RH2029, -2038
Servicing 10-159, 8HA2003F,
 Cargo 110164
 12 V.

Adjustable voltage

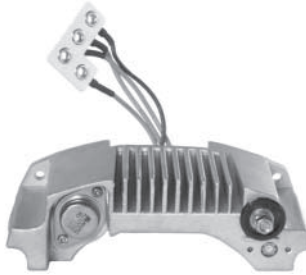

131180

Replacing 105-246, 8RL3011
Servicing 10-298, 8SC3014U,
 Cargo 110175
 24 V. 100 Amp.

Adjustable voltage



131851

Replacing 105-152, 8RF2012A
Servicing 8AR2073F
 12 V.

Adjustable voltage



131175

Replacing 105-230, 8RH2032
Servicing 8AL2056K, 8MA2014P,
 Cargo 110170
 12 V.

Adjustable voltage



131181

Replacing 105-229, 8RL3007
Servicing 10-258, Cargo 110176
 28 V. 175 Amp.

Adjustable voltage



131909

Replacing 105-151, 8RF2011A
Servicing 8AR
 12 V.
 W/ insulation diode

Replacing MOTOROLA US

Volt setting 15 V.



131910

Replacing 105-64, 8RS2010A
Servicing 8MR
 12 V.
 W/ insulation diode

Adjustable voltage



132151

Replacing 105-80, -130, 8RD2014
Servicing A12NTK451, 8HA,
 8MA, Cargo 110408, 110164
 12 V.
 W/ insulation diode

Volt setting 14.4 V.



133384

Replacing 105-266, 8RC2009A
Servicing 8E
 12 V.
 "FD" type, Diode trio sense

Adjustable voltage



131911

Replacing 105-153, 8AR2019K
Servicing 8AR 2019K, -2050F, -2051K
 12 V.
 W/ insulation diode

Adjustable voltage



132713

Replacing 105-115, 8RD 2011
Servicing 110-168, -169, -189, -190,
 8TA 2010E, -2011E, -2012E, -2014D
 12 V.

134450

Replacing 105-200, -202, 8RG2009B, -D
 12 V.



Adjustable voltage



131912

Replacing 105-181
Servicing 8HC, 8MR
 12 V.
 W/ insulation diode

Volt setting 14.4 V.



133383

Replacing 105-265, 44-7322, 8RC2008A
Servicing 8E
 12 V.
 "BS" type, Battery sense

134691

Replacing 105-252, 8RG2036, -2042
Servicing 8MR2059T, -2071T
 Case
 12 V.



Replacing MOTOROLA US

Adjustable Voltage



135304

Replacing 105-156, 8RD2022
12 V.

Adjustable voltage



135638

Replacing 105-237, 8RG2026
Servicing 8LHA2023VA, 8SA2023VA,
8SA 2035VA
12 V.

Adjustable voltage

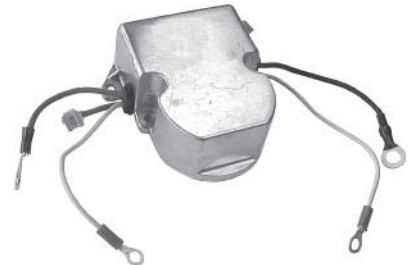

138126

Replacing 8RG2023, 105-224
Servicing 8LHA2022R, 8SA2022R,
110-250
12 V.

Adjustable Voltage



135305

Replacing 8RG2015, -2018, 105-193
12 V.

Adjustable voltage

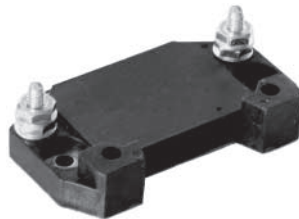

135855

Replacing 8RC 2013, 105-276
Servicing 3D97387G0, 5D357H1G01,
44-7927, 44-8901, Thermo King
12 V.

Adjustable voltage

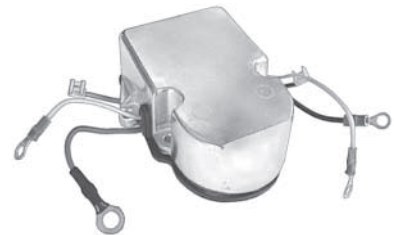

138593

Replacing 8RG2031, 105-245
Servicing 8HC2023K, -2024K, 110-284
12 V.
Wiring code: Red: positive, Black: ground,
Green: field, Yellow: stator

Adjustable Voltage



135307

Replacing 105-247, 8RG3029
Servicing 8HC3022F, 3025F
24 V.

Volt setting 15.2 V.



136263

Replacing 105-140, -178
Servicing 8RH2004F, -L, A12NW525,
-526, -527, -528, -529, -551, -552, -553
12 V.

Adjustable voltage



138765

Replacing 8RG2043, 105-280
Servicing 8MR2069T, -2070T, -2401U,
110-402, -403, -534, -602, -603
12 V. Marine applications

Replacing MOTOROLA US



139459

Replacing 8RG 2060A, 105-335
Servicing 8MR 2185L, 110-600,
 Thermo King
 12 V.



233640

Replacing 8RL2105, 105-340
Servicing 8SC2023Z, 110-565
 12 V.

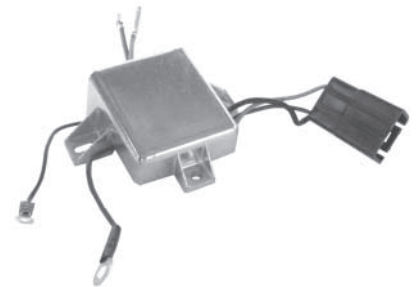

Volt setting 14.2 V.

234668

Replacing 105-121, 8RF2003
Servicing 8TA2009E, -2021E, -2023D,
 -2026E
 12 V.



233253

Replacing 8RH2012, 105-134, -701
Servicing 8AL series
 12 V.



234332

Replacing 105-149, 8RG3008
Servicing 8HC3010G, -3017G,
 110-196, -222
 24 V.

Volt setting 14.2 V

235353

Replacing 8RG2029A, -2112B, 105-292
Servicing 8LHA2027, -2057, -2070, -2073,
 -2081, -2096
 12 V.
 Wiring code: Red: positive, Black: ground,
 Green: field, Yellow: stator



233373

Replacing 105-207, 5-207
Servicing 8MR2026P, -2048K, -2049K,
 -2050F, -2051F
 12 V.

Volt setting 14.2 V.



234394

Replacing 105-104, 8RF2001
Servicing 8TA2003D, -2005D, -2019E,
 -2024D, 110-148, -204, -220
 12 V.
 Adjustable voltage

Replacing MOTOROLA US

Regulator Parts



234585

Replacing 103-49
Servicing 8HC3022F, -3025F,
 8LHA2022R, -2023V, -2024R, -2040RA,
 -2041VA, -2050VS, -2057V, -2070V
 Cork
 Gasket for regulator

Rectifiers



131887

Replacing 101-1, 101-151
Servicing 8AL , 8HA , 8AR
 Positive.
 Terminals 10-24 x 1 3/8"
 Used w/ Cargo 131888, 233244



131891

Replacing 101-137
Servicing 8MH2002P, -2007P
 Positive. 70 Amp.
 Terminal 1/4" - 20 x 1 3/4"
 Used w/ Cargo 131890, 131892



131888

Replacing 101-2
Servicing 8AL , 8HR , 8AR
 Negative.
 Terminals 10-24 x 1 3/8"
 Used w/ Cargo 131887, 131889, 233239



131892

Replacing 101-148
Servicing 8HC 2003P, 8MA 2003P,
 8MH 2001P, 8MR 2008P, -2009P, -2010P
 Negative. 70 Amp.
 Terminals 10-24 x 1 3/4"
 Used w/ Cargo 131891, 131893, 233239,
 233243



131889

Replacing 101-75
Servicing 8AL
 Positive.
 Terminals 1/4" - 20 x 1 3/8"
 Used w/ Cargo 131888



131893

Replacing 101-149
Servicing 8HC2001L, 8MA2003P,
 -2003P, 8MH2001P, 8MR2008P, -2009P
 Positive. 70 Amp.
 Terminals 10-24 x 1 3/8"
 Used w/ Cargo 131890, 131892

Replacing MOTOROLA US



133380

Replacing 101-207
Servicing 8E
 Marine applications



233238

Replacing 1-168, 101-168
Servicing 8MH2008P
 Negative
 Terminal post 1/4"-20 x 1 3/4"
 Used w/ Cargo 233239



233242

Replacing 1-169, 101-169
Servicing 8MR2025T, -2027T, -2028T, -2030T, -2033T, -2035T
 Positive 50 Amp. / 100 V. diodes
 W/ diode trio
 Terminal post 1/4"-20 x 1 3/4"



139460

Replacing 101-235
Servicing 8MR 2072LS, -2084K, -2085K, -2185L, -2198LS, -2199KS, -3005C
 Positive
 Terminals 1/4" - 20 x 1 3/4"
 Used w/ Cargo 139461



233239

Replacing 1-163, -164, 101-163, -164
Servicing 12N62, 8AL2021L, 8HC2013P
 Positive
 Terminal post 1/4"-20 x 1 3/4"
 Used w/ Cargo 131888, 131892, 139461, 233238



233243

Replacing 1-67, 101-67
Servicing 8MA3006F, -3007F, 8MH2003K, -2004F, -3005F, MA24902, MH12N602
 Positive 35 Amp. / 100 V. diodes
 Terminal post 10-24 x 1 3/4"
 Used w/ Cargo 131892



139461

Replacing 1-197, 101-193, -197
Servicing 8HC2007F, -2021K, -2023K, -2024K, -3006F, -3022F, -3025F, 8MR 2048k, -2049K, -2050K, -2084K, -2085K, -2185L, -2198LS
 Negative
 Terminals 10-24 x 1 3/4"
 Used w/ Cargo 139460, 233239



233241

Negative 50 Amp. / 100 V. diodes
 Terminal post 10-24 x 1 3/8"
 Terminal post 10-24 x 2"



233244

Replacing 1-165, 101-165
Servicing 12NP802, A12P800
 Negative
 Terminal post 10-24 x 1 3/8"

Replacing MOTOROLA US



233711

Replacing 101-170
Servicing 8MR2025T, -2027T, -2028T, -2033T, -2035T, -2059T, -2071T
 Negative



234400

Replacing 101-241
Servicing 8AL2046FA, -2055FA, -2080KA, -2106FA, -2108FA, -2109FA, -2110FD, -2111FA, -2116FB, -2171K, 8AR2015F, -2018L, -2062KA, -2100F, -2160FS, 8MR2069T, -2070T
 Positive

235356

Replacing 101-205
Servicing 8LHA2028V, -2032V, -2037V, -2041VA, -3031PA, - 8SA2023V, -2023VA, -2026VA, -2035VA, -3025P
 Diodes (6 - 50 Amp.)



235357

Servicing 8LHA...., 8SA....
 Diodes 6 - 50 Amp.
 W/ diode trio



Diode Trios

131885

Replacing 101-7
Servicing 8AL , 8HA
 Single insulation diode
 B+ terminal 1/4"



131886

Replacing 101-30
Servicing 8AL , 8RA , 8HA , 8MR
 Dual insulation diode
 B+ terminal 1/4"



131899 Std pkg 5

Replacing 101-130
Servicing 8AL

Replacing MOTOROLA US

Also see Diode Chapter page 780



133068

Replacing 101-184
Servicing 8LHC2004Z, 8SC2001R, -2004Z, -2007ZR, -3002U, -3003U, -3005V, -3008U, -3009Z, -3015U, -3019U, -4006U

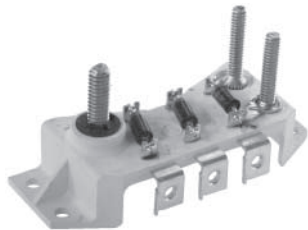

133381

Replacing 101-206
Servicing 8E
 W/ std. terminals
 B+ terminal 10 x 24 + 1/4"-20

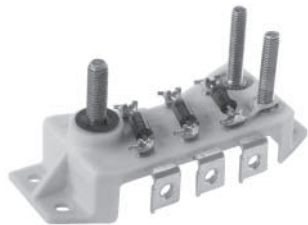

133382

Replacing 101-208
Servicing 8E
 W/ metric terminals
 B+ terminal M6-1.0 + M5-0.8



231429

Replacing 1-182, 101-182
Servicing 8AS3008P, 8SA2004R, -2007R, -3005P, -3021P, 12SA101B, -102A, -102B, -103B, -105B, -106A, -106B
 Terminal post 10-24 x 2"
 Leads 3 5/8", 9 Amp. trio



231437

Replacing 101-199
Servicing 8SC3011U, -3014U, 110-298

Diodes



137201

Replacing 102-42
 50 Amp. 200 V.
 1/2" (12.7 mm) press fit
 Positive



137202

Replacing 102-43
 50 Amp. 200 V.
 1/2" (12.7 mm) press fit
 Negative



234350 Std pkg 10

50 Amp. Avalanche
 12.8 mm press fit
 32-40 V.
 Negative



234351 Std pkg 10

50 Amp. Avalanche
 12.8 mm press fit
 32-40 V.
 Positive

Replacing MOTOROLA US

Slip Rings



132625 Std pkg 5
Replacing 112-22
Servicing 8SA , 8LHA ,
 8LHC , 8SC
 O.D. 25.4 mm, Shaft 10 mm, L. 22.1 mm



133925 Std pkg 10
Servicing 12-1, -2, -3, -5, -6, -14, -29
 O.D. 39.5 mm, Shaft 19 mm, L. 21 mm



233220
 O.D. 39.6 mm, Shaft 18.9 mm,
 L. 23.5 mm

Brush Boxes

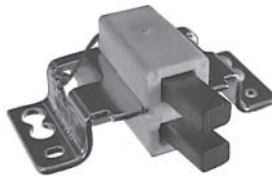

130543
Replacing 103-1
Servicing 8AL10-1, -2, -3, -113, -139
 1 terminal
 Complete w/ brushes

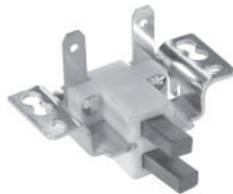

131920
Replacing 103-16
Servicing 8SA , 12SA
 2 terminal
 Complete w/ brushes



133069
Replacing 103-27
Servicing 8LHC2004Z, -2010Z,
 8SC2001R, -2004Z, -2007ZR, -2010Z
 Complete w/ brushes



133070
Replacing 103-46
Servicing 8LHA2023V, -3025P,
 8SA 2023V
 Complete w/ brushes

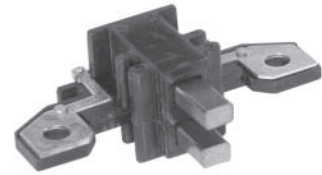

133385
Replacing 103-55
Servicing 8E
 Complete w/ brushes

Replacing MOTOROLA US

Also see Bearing Chapter page 821

Brush Sets



SVX7 2 Std pkg 10 **A**
 4.5 x 6.3 x 14 mm
 12 V.

Special Bearings



141110
Replacing 11-39, 111-39
Servicing 8SA-, 12SA-Series
 (W6203)
 17/40 x 17.5 mm

Roller Bearings



140490
Replacing 111-73
Servicing 8LHC2004Z, -2010Z,
 8SC2001R, -2004Z, -2007ZR, -2010Z
 27/47 x 14 mm
Inner race: Cargo 141019



141019
Replacing 111-74
Servicing 8LHC2004Z, -2010Z,
 8SC2001R, -2004Z, -2007ZR, -2010Z
 20/27 x 37 mm
 Inner race

Also see Pulley Survey
page 809

Replacing MOTOROLA US

Fan & Pulleys



133407

Replacing 107-8
O.D. 125 mm, Bore 15.88 mm (5/8")
Fan



134317

Replacing 107-20
Servicing 10-258, -298, 8SC3009, -3014,
Cargo 110175, 110176
O.D. 165 mm, Bore 22.23 mm (7/8")
Fan



131176

Replacing 107-51
Servicing Cargo 110173, 110175, 110176
Marine alternators
O.D. 78.8 mm, Bore 22.23 mm (7/8"),
W. 39.8 mm,
Double, B-type belt



133405

Replacing 107-1
O.D. 65.9 mm, Bore 15.88 mm (5/8"),
W. 20.4 mm,
Single



133406

Replacing 107-87
Servicing 8HA
O.D. 79 mm, Bore 15.88 mm (5/8"),
W. 19.6 mm,
Single, B-type belt



232159

Replacing 107-64
Servicing 8MR2006, -2010P,
MA12NJD604
O.D. 78.1 mm, Bore 15.88 mm (5/8"),
W. 19.4 mm,
Single, B-type belt



232160

Replacing 107-37
Servicing 8AR2041F, 8MR2001, -2002,
-2003, 8TA2009E, MA12NJD602, -1201
O.D. 71.5 mm, Bore 15.88 mm (5/8"),
W. 29.9 mm,
Double



232161

Replacing 107-43
Servicing 8AR2006K, -2007D, -2013K,
-2014K, -2019F, -2050F, -2051K, -2074F
O.D. 79.1 mm, Bore 15.88 mm (5/8"),
W. 35.5 mm,
Double, B-type belt

Replacing NIKKO

Rotors

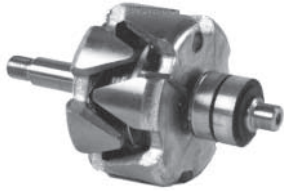

132507

Replacing 0-33100-1380
Servicing 0-33000-5480, -5510, -5540, -5670, -6250
 Atlas Copco
 24 V. 15/17 Amp.
 L. 149.5 mm, O.D. 83.2 mm, Shaft 15 mm



132510

Replacing 7-33100-0500
Servicing Fiat Allis
 24 V. 25 Amp.
 L. 246 mm, O.D. 92.3 mm, Shaft 25 mm,
 10 splines



135689

Replacing 0-33100-1450
Servicing 0-33000-5770, -5771, -5840, -5850, -5860, -5870, -5880, -5990, -6000, -6070, -6200, -6210, -6260, -6280, -6290
 24 V. 25 Amp.
 L. 183 mm, O.D. 88 mm, Shaft 25 mm



132508

Replacing 1-33100-0930
Servicing 0-33000-3630, -3631, -3690, -3700, -3710, -3760, -5700, -5710, -6160
 Clark B35
 24 V. 25 Amp.
 L. 187 mm, O.D. 91.2 mm, Shaft 25 mm



135538

Replacing 1-33100-0950
Servicing 0-33000-3720, -4500, -4740, -4830, -4850, 0-39000-0050, -0060
 24 V. 25 Amp.
 L. 247 mm, O.D. 92.2 mm, Shaft 25 mm,
 10 splines



132509

Replacing 7-33100-0120
Servicing 0-33000-2290, -2280, -2281, -2330, -2300
 Komatsu
 24 V. 13 Amp.
 L. 183 mm, O.D. 92.2 mm, Shaft 25 mm



135688

Replacing 1-33100-1270
Servicing 0-33000-5020, 0-35000-3010, -3011, -3012, -3013, -3020, -3040, -3050
 24 V. 40 Amp.
 L. 189 mm, O.D. 106 mm, Shaft 25 mm
Rotor coil: Cargo 135690

Replacing NIKKO

Rotor Parts



135690

Replacing 0-33120-0220

Servicing 0-35000-3000, -3010, -3011, -3012, -3013, -3020, -3040, -3050, -3060, -3070, -3080, -3100, -3110, -3120, -3130
24 V. 40 Amp.

Rotor coil

Stators



132512

Replacing 1-33200-0970

Servicing 0-33000-3700, -3710, -3711, -3750, -3760, -4010, -4060, -4140, -4240, -4500, -4590, -4670, -4750, Fiat Allis, Isuzu
24 V. 25 Amp.

O.D. 121 mm, I.D. 92 mm, W. 28 mm



135541

Replacing 1-33200-1230

Servicing 0-33000-5020, 0-35000-3000, -3020, -3040, -3050, -3070, -3080, -3090, -3100, -3110, -3120, -3130, -3140, -3150
24 V. 35 Amp.

O.D. 141 mm, I.D. 106.5 mm, W. 28 mm



135539

Replacing 1-33200-1000

Servicing 0-33000-2200, -2280, -2281, -2290, -2300, -2330, -3230, -3300, -3450, -3500, -3501, -5140, -5150, -5260, -5400
24 V. 13 Amp.

O.D. 125 mm, I.D. 93 mm, W. 28.1 mm



135685

Replacing 0-33200-1381

Servicing 0-33000-5670, -6240, -6250
24 V. 20 Amp.

O.D. 113 mm, I.D. 84.5 mm, W. 23 mm



135540

Replacing 0-33200-1410

Servicing 0-33000-5840, -5850, -5860, -5870, -5880, -6000, -6200, -6280, -6290, -6310, -6350, -6351, -6430, -6460, -6510, -6511, 0-39000-0260, -0270, -0280, -0290
24 V. 25 Amp.

O.D. 121 mm, I.D. 88.1 mm, W. 24.2 mm

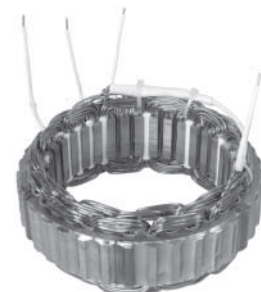

135686

Replacing 1-33200-1210

Servicing 0-35000-3010, -3011, -3012, -3013, -3210, -3270, -3370, -3410, -3571, -3610, -3612, -3613, -3660, -3680, -3740, -3800, -3830, -3840, 0-39000-4000
24 V. 40 Amp.

O.D. 145 mm, I.D. 107 mm, W. 28 mm

Replacing NIKKO



135687

Replacing 0-33200-1311
Servicing 0-33000-5480, -5510, -5540, -5700, -5710
 24 V. 15 Amp.
 O.D. 113 mm, I.D. 84 mm, W. 23 mm



135747

Replacing 1-33200-0300
Servicing 0-33000-1130, -1140, -1150, -1160, -1180, -1321, -2571, -3200, -3350, -3430, -4130, -4550, -4820, -5170
 24 V. 35 Amp.
 O.D. 164 mm, I.D. 121 mm, W. 48.4 mm



136140

Replacing 1-33200-1070
Servicing 0-33000-4180, -4181
 24 V. 30 Amp.
 O.D. 125 mm, I.D. 93 mm, W. 28 mm

Regulators



131537

Replacing 0-41000-2190, -2390, -2640
Servicing Isuzu
 24 V.
 Mechanic



132092

Replacing 1-44000-0580, -0730
Servicing 0-33000-0120, -0140, -0050, -0060, -2200, -2280, -2290, -2330, -2841, -2870, -2871, -2880, -3070, -3071, -3111
 Isuzu, Komatsu industrial
 24 V.



134351

Replacing 0-41000-0100, 0-44000-1250
 24 V. 35 Amp.

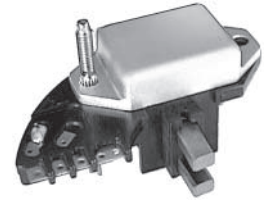

135296

Replacing 0-33719-0030, -0031
Servicing 0-33000-5840, -5850, -5860, -5870, -5880, -6000, -6200, -6280
 24 V.



135321

Replacing 7-44000-0900
Servicing 0-35000-0050, -0060, -0070, -0080, -0110, -0160, -0200, -0230, -0260, -0310, -0320, -0360, -3011, -3013, -3270
 24 V.
Repair circuit: Cargo 133696



135322

Replacing 7-44000-0907
Servicing 0-35000-3000, -3020, -3050, -3070, -3150, -3180, -3190, -3220, -3230, -3240, -3280, -3290, -3300, -3380, -3390
 24 V.
Repair circuit: Cargo 133696

Replacing NIKKO



135680

Replacing 0-33730-2560
Servicing 0-33000-5840, -5850, -5860, -5870, -5880, -6280, -6290, -6430, -6510
 6 diodes, w/ rectifier
 24 V.
 Terminals E-F-R-B-S
 (L)



135691

Replacing 7-44000-0901
Servicing 0-35000-0030, -0120, -0290, -0330, 0-39000-2010
 24 V.
 Repair circuit: Cargo 133696

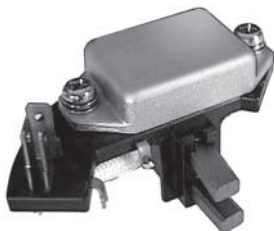

135692

Replacing 7-44000-0910, -0950
Servicing 0-33000-5650, -5660
 12 V.



139331

Replacing 0-33719-0080, 7-44000-0903
Servicing 0-33000-5480, -5510, -5540, -5670, -5700, -5710, -6240, -6250
 24 V.

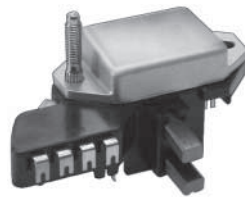

230160

Replacing 0-33719-0090
Servicing 0-33000-5771, -6542
 24 V.
 Terminals: E-F-R-B-S
 (L)

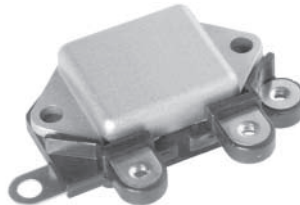

234999

Replacing 0-37519-0150, -0151
Servicing 0-35000-0481, -0521, -0531, -0541, -0561, -0571, -0591, -0601, -0621, -0631, -4530
 24 V. Terminals S-B-(L)-F-E
 I.C. Regulator R

Regulator Parts



133696

Servicing 0-35719-0060, -0070, -0110, -0140, -0151, -0160, -0180, -0200, -0210, 7-44000-0900, -0901, -0902, -0903,
 Cargo 135321, 135322
 24 V.
 Terminals E-F-R-B-S
 Repair circuit (L)

Replacing NIKKO

Rectifiers



132490

Replacing 0-33730-1600
Servicing 0-33000-2280, -2281, -2290, -2870, -3071, -3111, -3300, -3500
 Komatsu



135680

Replacing 0-33730-2560
Servicing 0-33000-5280, -5840, -5850, -5860, -5870, -5880, -6510, -6511
 6 diodes, w/ diode trio and regulator
 24 V.
 Terminals E-F-R-B-S
 (L)



135683

Replacing 0-33730-2271
Servicing 0-33000-5770, -5990, -6000, -6070, -6200, -6210, -6280, -6310
 6 diodes, w/ diode trio



132491

Replacing 0-33730-1800
Servicing 0-33000-3700, -5090, 0-39000-0120, -0140
 Fiat Allis, Isuzu



135681

Replacing 0-33730-2190
Servicing 0-35000-3000, -3020, -3040, -3050, -3070, -3080, -3100, -3110, -3120, -3130, -3140, -3150, -3190, -3200, -3220, -3230, -3240, -3250, -3280, -3290, -3300
 6 diodes, w/ diode trio



135684

Replacing 0-35730-0011
Servicing 0-35000-3013, -3270, -3370, -3410, -3480, -3571, -3610, -3612, -3613, -3800, -3830, -3840
 6 diodes, w/ diode trio



132511

Replacing 0-33730-2300
Servicing 0-33000-5480, -5910, -5540, -5670, -5710, -6250
 Atlas Copco
 6 diodes, w/ diode trio



135682

Replacing 0-35730-0080
Servicing 0-35000-0030, -0040, -0050, -0060, -0070, -0080, -0090, -0100, -0110, -0120, -0130, -0140, -0150, -0160, -0180, -0190, -0200, -0210, -0220, -0230, -0240,
 6 diodes, w/ diode trio



234578

Replacing 0-35730-0270, -0300, -0460
Servicing 0-35000-3763, -3861, -3863, -3871, -3872, -3892, -3991, -4000, -4121
 8 diodes
 W/ diode trio

Replacing NIKKO

Slip Rings



135535

Replacing 1-33130-0172
Servicing 0-33000-2153, -2155, -2200, -2280, -2281, -2290, -2300, -2330, -2550, -2620, -2670, -2800, -2801, -2810, -2841, -2850, -2870, -2871, -2880, -2881, -2920
 O.D. 34.2, Shaft 20.6 mm, L. 32.5 mm



135536

Replacing 1-33130-0230, 7-33130-0230
Servicing 0-33000-3630, -3631, -3640, -3650, -3651, -3690, -3700, -3710, -3711, -3720, -3750, -3760, -3780, -3790, -3800, -3810, -3820, -3830, -3840, -3850, -3880
 O.D. 34, Shaft 20.6 mm, L. 33.4 mm



135537

Replacing 1-33140-0140
Servicing 0-33000-1130, -1131, -1140, -1150, -1160, -1180, -1181, -1321, -1370, -1800, -1870, -1980, -2090, -2100, -2110, -2120, -2360, -2500, -2571, -2790, -2910
 O.D. 48, Shaft 20.6 mm

Brush Boxes



132504

Replacing 1-33720-0691
Servicing 0-33000-3700
 Fiat Allis, Isuzu, Clark
 24 V. Complete w/ brushes
Brush set: Cargo 140605



132505

Replacing 1-33720-0792
Servicing 0-33000-2280, -2281, -2290, -2330, -3070, -3071, -3300, -4580, -4590
 Komatsu
 24 V. Complete w/ brushes
Brush set: Cargo 140605

Brush Sets



140605 Std pkg 10

Servicing Brush box 1-33720-0630, Cargo 132504, 132505
 6 x 7 x 20/18 mm
 24 V.



140606 Std pkg 10

Replacing 02166-00130
 5 x 8 x 18 mm
 24 V.



140607 Std pkg 10

Replacing 1-33740-0380
 6 x 7 x 16/14 mm
 12/24 V.



140951

Replacing 1-33740-0450
 5 x 7 x 19/17 mm
 12/24 V.

Replacing NIKKO

Also see Pulley Survey
page 809

Fan & Pulleys



232332

Servicing 0-33000-5840, -5850, -5880
O.D. 95.1 mm, Bore 22.23 mm (7/8"),
W. 58.8 mm
Double, C-type belt

Replacing NIPPONDENSO

Rotors



135837

Replacing 021200-2330, -2610, -2960
Servicing 100211-1001, -1011, -1021, -1031, -1041, -1061, -1074, -1091, -1121
 12 V. 55/75 Amp.
 L. 147 mm, O.D. 89 mm, Shaft 15 mm
Shaft: Cargo 137774



135949

Replacing 021200-3100, -4670, -4770
Servicing 100211-0151, -2130, -2140
 12 V. 65/70 Amp.
 L. 147 mm, O.D. 89 mm, Shaft 15 mm
 Anti CW rotation
Shaft: Cargo 137774

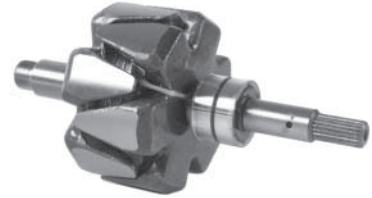

136193

Replacing 021200-2320
Servicing 021000-9930, -9931, -9960, 100210-2210, -2251, -2280, -2360, -2560
 24 V. 20/30 Amp.
 L. 192 mm, O.D. 91.2 mm, Shaft 20 mm, 18 splines
Shaft: Cargo 133504



135838

Replacing 021200-2570, -3030, -3033
Servicing 100211-1224, -1231, -1251, -1341, -2221, -2231, -2250, -2280, -2290
 12 V. 50/55 Amp.
 L. 140 mm, O.D. 82.7 mm, Shaft 15 mm
Shaft: Cargo 135112



135950

Replacing 021200-2311
Servicing 021000-8270, -8271, -8310, -8311, -8330, -8340
 12 V. 55 Amp.
 L. 147.5 mm, O.D. 96 mm, Shaft 17 mm
Shaft: Cargo 137775



136448

Replacing 021200-2340, -2350, -2390
Servicing 100213-0202, -0231, -0250
 12 V. 55/60 Amp.
 L. 192 mm, O.D. 96 mm, Shaft 20 mm, 18 splines
Shaft: Cargo 133504



135839

Replacing 021200-2880
Servicing 100211-1440
 12 V. 45 Amp.
 L. 140 mm, O.D. 76 mm, Shaft 15 mm
Shaft: Cargo 135112



136192

Replacing 021200-2280, -2520, -3200
Servicing 100210-2610, -2700, -2710, -2720, -2840, -3240, -3280, -3350
 12 V. 40/45 Amp.
 L. 192 mm, O.D. 91.2 mm, Shaft 20 mm, 18 splines
Shaft: Cargo 133504



136616

Replacing 021200-2740, -3040, -4361
Servicing 100211-1261, -1271, -1311, -1351, -1381, -2340, -3580, -3590, -3600
 12 V. 55/60 Amp.
 L. 140 mm, O.D. 82 mm, Shaft 15 mm
 Anti CW rotation
Shaft: Cargo 135112

Replacing NIPPONDENSO

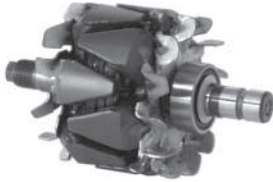

136617

Replacing 021200-2511
Servicing 100211-1400, -1401, -1402, -1410, -1411, -1420, -1451, -1452, -1453
 12 V. 40 Amp.
 L. 133 mm, O.D. 77 mm, Shaft 15 mm
Shaft: Cargo 135111



137394

Replacing 021200-4131
Servicing 100211-7170, -7370, -7380, -7670, -7850
 24 V. 30 Amp.
 L. 147 mm, O.D. 89 mm, Shaft 15 mm
Shaft: Cargo 137774

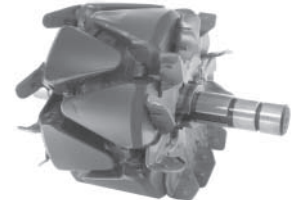

137684

Replacing 021200-4150
Servicing 100213-1130
 12 V. 70 Amp.
 L. 129.4 mm, O.D. 91.8 mm, Shaft 17 mm

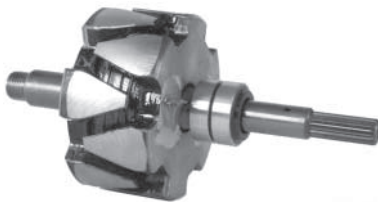

136898

Replacing 021200-3330, 27330-54290
Servicing 100210-3270, -3360
 12 V. 50 Amp.
 L. 201 mm, O.D. 96.2 mm, Shaft 20 mm, 18 splines
Shaft: Cargo 136951



137422

Replacing 021200-0480, -1390
Servicing 021000-1603, -2840, -2991, -3040, -4550, -4550, -5490, -6840, -6851
 12 V. 25 / 40 Amp.
 L. 135 mm, O.D. 81.7 mm, Shaft 15 mm
Shaft: Cargo 137776



137799

Replacing 021200-3310, -5620
Servicing 100211-1520, -1560, -1570, -4160, -4170, -4290, -4320, -6600, -6640
 12 V. 45 Amp.
 L. 140 mm, O.D. 76.3 mm, Shaft 15 mm
Shaft: Cargo 135112

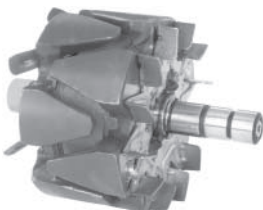

137373

Replacing 021200-3360
Servicing 100213-0700, -0730, -0941, -1030, -1040, -1140, -1250, -1260, -1740, -1780, -1790, -1910, -2220, -2250
 12 V. 60/70 Amp.
 L. 121 mm, O.D. 89.1 mm, Shaft 17 mm



137667

Replacing 021200-4140
Servicing 100211-6200
 24 V. 50 Amp.
 L. 157 mm, O.D. 113 mm, Shaft 17 mm



137970

Replacing 021200-3291, -3520, -3430
Servicing 100211-1610, -1630, -1632, -1650, -1670, -1680, -1690, -4460, -4490
 12 V. 40 Amp.
 L. 135 mm, O.D. 69 mm, Shaft 15 mm
Shaft: Cargo 135097

Replacing NIPPONDENSO

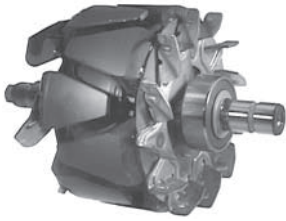

138162

Replacing 021200-2950
Servicing 100211-2400, -2820, -2830, -2840, -2850, -2860
 12 V. 80 Amp.
 L. 155.5 mm, O.D. 97 mm, Shaft 17 mm



138571

Servicing 121000-3000, -3100, -3300, -3310, -3330, -3360, -3370, -3380, -3390, -3400, -3430, -3450, -3480
 12 V. 90 Amp.
 L. 147 mm, O.D. 91 mm, Shaft 17 mm



138666

Replacing 021200-0650, -0651, -0991
Servicing 021000-3021, -7450, 100210-0442, -1390, -1391, -1400, -1401
 24 V. 15/20 Amp.
 L. 224 mm, O.D. 91.5 mm, Shaft 20 mm, 10 Splines



138375

Replacing 021200-3790
Servicing 100211-8150, -8151, -8190, -8260, -8270, -8280, -8440
 12 V. 70/80 Amp. Anti CW-rotation
 L. 150 mm, O.D. 91 mm, Shaft 17 mm
Shaft: Cargo 137769



138572

Replacing 021200-3380, -5420
Servicing 100211-1550, -2022, -2060, -2130, -2190, -2230, -2310
 12 V. 60 Amp.
 L. 140 mm, O.D. 76 mm, Shaft 15 mm
Shaft: Cargo 135112



138747

Replacing 021200-5400
Servicing 100210-3660, -3720, -3740, -3760, 121000-7970, -8010, -8030, -8050
 12 V. 45 Amp.
 L. 192 mm, O.D. 91 mm, Shaft 20 mm, 10 Splines

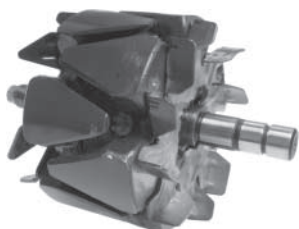

138416

Replacing 021200-5940
Servicing 100211-6030, -6031, -6420, -6430, -7510
 12 V. 120 Amp.
 L. 157 mm, O.D. 101.4 mm, Shaft 17 mm



138573

Servicing 121000-4000, -4010, -4030, -4040, -4050, -4060, -4070, -4080, -4090
 12 V. 120 Amp.
 L. 153 mm, O.D. 101 mm, Shaft 17 mm



138760

Replacing 021200-3350
Servicing 100211-1600, -1620, -4410
 12 V. 40 Amp.
 L. 140 mm, O.D. 69.2 mm, Shaft 15 mm
Rotor shaft: Cargo 135112

Replacing NIPPONDENSO



138860

Replacing 021200-2270
Servicing 021000-9850, -9851, -9980,
 100210-2290, -2302, -2370, -2570
 24 V. 25 Amp.
 L. 192 mm, O.D. 96 mm, Shaft 20 mm,
 18 splines

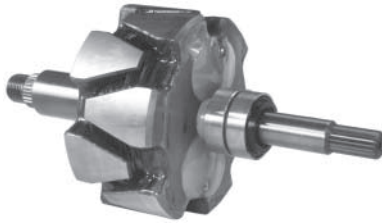

230695

Replacing 021200-3420, -4050, -4110
Servicing 100213-0520, 121000-2130
 24 V. 40 Amp.
 L. 211.5 mm, O.D. 103.0 mm, Shaft 25 mm,
 18 splines



231181

Replacing 021200-3930, -5000
Servicing 100211-8000, -8010, -8020,
 -8030, -8060, -8070, -8090, -8100, -8110,
 -8120, -8130, -8190, -8230, -8240, -8300
 12 V. 70/80 Amp.
 L. 150 mm, O.D. 91 mm, Shaft 17 mm



138955

Replacing 021200-1680, -4480
Servicing 021000-8420, 100211-0230,
 7N4784
 12 V. 40 Amp.
 L. 148 mm, O.D. 91 mm, Shaft 17 mm



230893

Replacing 021200-5410
Servicing 100210-3680, 121000-7990
 12 V. 55 Amp.
 L. 192 mm, O.D. 96 mm, Shaft 20 mm,
 10 splines

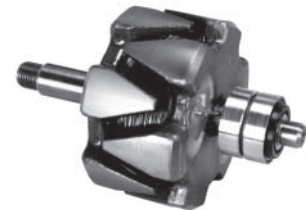

231665

Replacing 021200-2050
Servicing 100211-0420, -0421, -0422,
 -0440
 12 V. 55 Amp.
 L. 148 mm, O.D. 91.3 mm, Shaft 17 mm

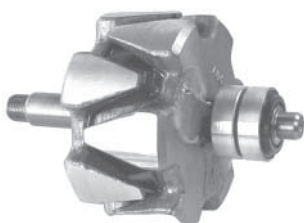

230473

Replacing 021200-2001, -2070, -2071
Servicing 021000-9770, 100211-0560,
 -0580, -0581, -0630, -0650, -0660, -0720,
 -0730, -0731, -0740, -0760, -0761, -0991
 12 V. 60 Amp.
 L. 148.3 mm, O.D. 96 mm, Shaft 17 mm



230965

Replacing 021200-1130, -1180, -2840
Servicing 021000-0441, -0490, -3630,
 -3641, -5020, -5040, -5046, -5080, -5111,
 -5130, -5141, -5150, -5160, -5170, -5240
 12 V. 50 Amp.
 L. 148 mm, O.D. 91 mm, Shaft 17 mm



235058

Replacing 021200-5270, -6200
Servicing 100210-3580, -3770, -3820,
 -3871, 121000-7710, -8070, -8281
 12 V. 55 Amp.
 L. 202 mm, O.D. 96 mm, Shaft 20 mm,
 10 splines



Replacing NIPPONDENSO



235059

Replacing 021200-6780
Servicing 102211-5050, -5090, -5280
 12 V. 70 Amp.
 L. 143 mm, O.D. 86 mm, Shaft 15 mm



Rotor Parts



133504

Servicing 021200-2280, -2320, -2340, -2350, -2390, -2520, -2930, -2940, -3200,
 Cargo 136192, 136193, 136448
 L. 192 mm, Shaft 20 mm, 18 Splines
 Rotor shaft



136951

Servicing 021200-3330, -5270,
 Cargo 136898
 L. 201 mm, Shaft 20 mm, 18 splines
 Rotor shaft



135097

Servicing 021200-3291, -3430, -3520,
 Cargo 137970
 L. 135.5 mm, Shaft 15 mm
 Rotor shaft



137769

Servicing 021200-3790, -5020,
 Cargo 138375
 L. 150 mm, Shaft 17 mm
 Rotor shaft



135111

Servicing 021200-2511, -3380,
 Cargo 136617
 L. 135 mm, Shaft 15 mm
 Rotor shaft



137774

Servicing 021200-2330, -2610, -2960,
 -2962, -4131, -5060, -5160,
 Cargo 135837, 135949, 137394
 L. 147 mm, Shaft 15 mm
 Rotor shaft



135112

Servicing 021200-2310, -3310,
 Cargo 135838, 135839, 136616, 137799,
 138572, 138760
 L. 140 mm, Shaft 15 mm
 Rotor shaft



137775

Servicing 021000-2311, Cargo 135950
 L. 147.5 mm, Shaft 17 mm
 Rotor shaft

Replacing NIPPONDENSO



137776

Servicing 021200-0480, -1390,
Cargo 137422
L. 135 mm, Shaft 15 mm
Rotor shaft



191298 Std pkg 100 A

Replacing 949056-2520
M14-1.5
Rotor shaft nut



231783

Replacing 027304-0081
Servicing 021000-2522, -2532, -2542,
-4580, -4630, -5310, -5380, -7000, -7040
M20-1.5
Anti CW rotation
Nut



231508

Replacing 021045-0130, -0690
O.D. 23 mm, Bore 17 mm, Th. 8.2 mm
Rotor spacer



231676

Replacing 027302-0020
Servicing 021000-4510, -7750, -7961,
-7970, -7971, -7990, -8010, -8011, -8021,
-8420, -8460, -8470, -9020, -9091, -9100
O.D. 24.4/30 mm, Bore 17 mm, Th. 6 mm
Rotor spacer



234055 Std pkg 5

Servicing 021000-2991, -3040, -5490,
-9561
O.D. 20 mm, Bore 15 mm, Th. 7.4 mm
Rotor spacer

Stators



131306

Servicing 021100-1321, -5950
Daihatsu, Toyota
Must change stator leads
12 V. 50 Amp.
O.D.128 mm, I.D. 93 mm, W. 24 mm



132861

Replacing 021100-2461, -3570
Servicing 100211-1021, -1041, -1061,
-1074, -1091, -1141, -1171, -2001, -2031,
-2050, -2080, -2110, -2130, -2140, -2150
12 V. 55/60/65 Amp.
O.D. 118 mm, I.D. 90 mm, W. 25.8 mm



133203

Replacing 021100-0470, -2340, -2480
Servicing 100211-1210, -1211, -1212,
-1224, -1231, -1251, -1261, -1271, -1311,
-1341, -1351, -1381, -2221, -2231, -2250
12 V. 50/55/60 Amp.
O.D. 110 mm, I.D. 83 mm, W. 24.5 mm

Replacing NIPPONDENSO



133671

Replacing 021100-3200, -3500, -3510
Servicing 100210-3381, 100211-8090, -8100, -8130, -8250
 12 V. 70/80 Amp.
 O.D. 118 mm, I.D. 92 mm, W. 28.2 mm



133748

Replacing 021100-1960, -2650
Servicing 021000-5030, -5180, -7920, -7931, -792, -7940, -7980, -8010, -8011, -8020, -8021, -8030, -8040, -8090, -8400
 12 V. 45 Amp.
 O.D. 119 mm, I.D. 92 mm, W. 22 mm



135414

Replacing 021100-4080, -4110
Servicing 100211-6030, -6031, 121000-4000, -4010, -4030, -4040, -4050, -4060, -4070, -4080, -4080, -4090
 12 V. 120 Amp.
 O.D. 130 mm, I.D. 102 mm, W. 30.3 mm

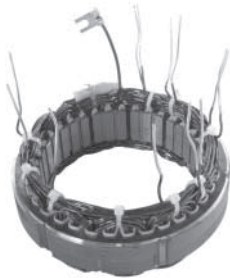

133720

Replacing 021100-2120, -2320
Servicing 021000-7570, -9660, 100210-1550, -1551, -1551, -1552, -1553, -1555, -1572, -2340, -2343, -2540, -2600
 12 V. 55/65 Amp.
 O.D. 128 mm, I.D. 97 mm, W. 20.9 mm



135138

Replacing 021100-2291, -3400
Servicing 100210-3070, -3190, -3210, -3410, 100211-1001, -1011, -1031, -1121, -1131, -2021, -2071, -2102, -2410, -2420
 12 V. 70/75/80 Amp.
 O.D. 118 mm, I.D. 90 mm, W. 26.3 mm



135625

Replacing 021100-2860, -2870, -3000
Servicing 100211-1511, -1550, -1570, -4002, -4003, -4020, -4050, -4091, -4111, -4120, -4160, -4170, -4180, Chrysler
 12 V. 50 Amp.
 O.D. 100 mm, I.D. 77 mm, W. 25.6 mm



133745

Replacing 021100-1820, -2110, -2330
Servicing 100210-2750, -3270, -3360, 121000-1012
 12 V. 50 Amp.
 O.D. 128 mm, I.D. 97 mm, W. 21 mm



135413

Replacing 021100-3490
Servicing 102211-1461, 121000-2430, -2680, -3000, -3100, -3300, -3310, -3330, -3360, -3370, -3380, -3390, -3400, 3430
 12 V. 90 Amp.
 O.D. 118 mm, I.D. 92 mm, W. 27.8 mm



135941

Replacing 021100-2702, -2890
Servicing 100211-1600, -1610, -1630, -1650, -4460, -4550, -4560, -4631
 12 V. 40 Amp.
 O.D. 93 mm, I.D. 69.6 mm, W. 25.7 mm

Replacing NIPPONDENSO



136101

Replacing 021100-0291
Servicing 021000-1083, -1602, -2490, -2500
 12 V. 30 Amp.
 O.D. 114 mm, I.D. 82.4 mm, W. 14.3 mm



137051

Replacing 021100-3381
Servicing 100211-7170, -7370, -7380, -7670, -7850, -7880, 101211-0260, -0320, -0330, -0600, -0610
 24 V. 30 Amp.
 O.D. 118 mm, I.D. 90 mm, W. 25.5 mm



137973

Replacing 021100-0880
Servicing 021000-2840, -4550, -6840, -6940, -7250, -7370, -8130, -8140, -8610, -8620, -9590, 100211-0170, -0830, -0840
 12 V. 20/35 Amp.
 O.D. 113.5 mm, I.D. 82 mm, W. 14 mm

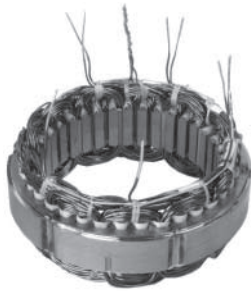

136247

Replacing 021100-1600, -1870, -2040
Servicing 021000-9180, 021000-8870, -8910, 100210-2040, -2080, -2211, -2290, -2302, -2570, -2861
 24 V. 25 Amp.
 O.D. 128 mm, I.D. 97 mm, W. 21 mm



137372

Replacing 021100-2380, -2620
Servicing 100210-2720, -2840, -3080, -3240, -3280, -3350, 121000-0850, -1480, -2150, -2740, -2980
 12 V. 45 Amp.
 O.D. 118.8 mm, I.D. 92 mm, W. 22 mm



138161

Replacing 021100-2782, -2781, -2783
Servicing 100211-2400, -2820, -2830, -2840, -2850, -2860
 12 V. 80 Amp.
 O.D. 128 mm, I.D. 98 mm, W. 29.5 mm



136907

Replacing 021100-2360, 27410-54180
Servicing 100213-0231, -0250, -0300, -0610, -0850, -0860
 12 V. 60 Amp.
 O.D. 128 mm, I.D. 97 mm, W. 21 mm



137668

Replacing 021100-3390, -4090
Servicing 100211-6200
 24 V. 50 Amp.
 O.D. 130 mm, I.D. 102 mm, W. 30.7 mm



138667

Replacing 021100-0630, -0750
Servicing 021000-3021, -7000, -7040, 100210-1390, -1391, -1400, -1401, -1890
 24 V. 15/20 Amp.
 O.D. 127.8 mm, I.D. 92 mm, W. 20.5 mm

Replacing NIPPONDENSO



138730

Replacing 021100-3900
Servicing 101211-2001, -2011, -2022, -2060, -2090, -2130
 12 V. 60 Amp.
 O.D. 100 mm, I.D. 77 mm, W. 25.5 mm



139351

Replacing 021100-2740
Servicing 100210-2950, -2960, -2980, -2991, -4070, -4080, -4100, -4470, 121000-1710, -1720, -1770, -5170, -8480
 24 V. 30 Amp.
 O.D. 127.7 mm, I.D. 97 mm, W. 20.7 mm



230908

Replacing 021100-3420, -4070
Servicing 100211-5070, -5270, -6010, -6020, -6060, -6080, -6100, -6110, -6120, -6140, -6150, -6170, -6180, -6190, -6300
 12 V. 100 Amp.
 O.D. 130 mm, I.D. 102 mm, W. 30 mm



138758

Replacing 021100-0950
Servicing 021000-0470, -1340, -1860, -2470, -3630, -3641, -5020, -5040, -5046, -5080, -5081, -5111, -5130, -5141, -5151
 12 V. 40 Amp.
 O.D. 128 mm, I.D. 92 mm, W. 20.8 mm



139998

Replacing 021100-2130, -2750
Servicing 021000-9930, -9931, -9960, 100210-2250, -2251, -2280, -2360, -2560, -2810, -4230, -4290, 121000-0100, -0660
 24 V. 25 Amp.
 O.D. 118.5 mm, I.D. 91.5 mm, W. 22.2 mm



231266

Replacing 021100-4320
Servicing 102211-5090
 12 V. 70 Amp.
 O.D. 112 mm, I.D. 86.5 mm, W. 26.7 mm

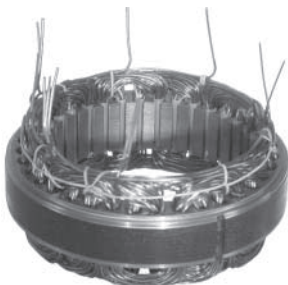

139322

Replacing 021100-2610
Servicing 021000-9861, 100210-2221, -2350, -2620, -2660, -2710, -3230, -3610, -3730, -4220, 100211-0211, 121000-0090
 12 V. 40 Amp.
 O.D. 124 mm, I.D. 108 mm, W. 22 mm



230696

Replacing 021100-2920, -3410
 24 V. 40 Amp.
 O.D. 138 mm, I.D. 104 mm, W. 21 mm

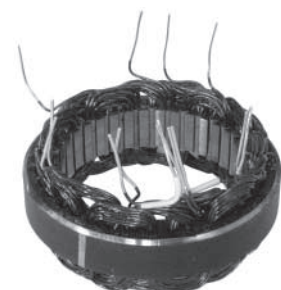

231514

Replacing 021100-2150
Servicing 100210-3400, -3460, -3871, 100213-0750, -0760, -0950, -0960
 12 V. 55 Amp.
 O.D. 128 mm, I.D. 97 mm, W. 21 mm

Replacing NIPPONDENSO



231730

Replacing 021100-1790
Servicing 100211-0290, -0291, -0292
 12 V. 90 Amp.
 O.D. 128 mm, I.D. 97 mm, W. 21 mm



237417

Servicing 102211-8000 
 12 V. 70 Amp.
 O.D. 118 mm, I.D. 92 mm, W. 26.6 mm

Brackets D.E.



133905

Replacing 021401-3670
Servicing 100211-1000, -1001, -1010, -1011, -1020, -1021, -1040, -1041, -1060, -1061, -1140, -1141, -1170, -1171, -2020, -2021, -2070, -2071, -2170, -2470, -2480
Bearing: Cargo 140239

234582

Replacing 021100-2311, -2371
Servicing 100211-1400, -1401, -1402, -1410, -1411, -1440
 12 V. 45 Amp.
 O.D. 103 mm, I.D. 77 mm, W. 23 mm



136136

Replacing 021401-3990
Servicing 100211-2250, -3520, -3680
Bearing: Cargo 140239

235223

Replacing 021100-3500, -3510, -3930 
Servicing 100211-8150, -8151, -8190, -8270, -8380, -8410, -8440, -8700, -8960
 12 V. 70/80 Amp.
 O.D. 118 mm, I.D. 92 mm, W. 28.2 mm



136137

Replacing 021401-4670
Servicing 100211-3401, -3410, -7040, -7090, -7100, -7110, -7130, -7140, -7160, -7210, -7300, -7310, -7430, -7470, -7780, -7840, -7850, -7870, -7880, -7910
Bearing: Cargo 140462

Replacing NIPPONDENSO



136239

Replacing 021401-3750
Servicing 100211-2221, -2231, -2290, -3580, -3590, -3640, -3660, -3850, -3870, -3910
Bearing: Cargo 140239



136336

Replacing 021401-3680
Servicing 100211-2140, -2150, -7250
Bearing: Cargo 140091



136569

Replacing 021401-4100, -4310
Servicing 100211-1570, -1571, -6600, -6720, -9220
Bearing: Cargo 140461



136244

Replacing 021401-4360
Servicing 100211-4080, -4120, -4180, -9320, -9330, -9340
Bearing: Cargo 140084



136446

Replacing 021401-4290
Servicing 100211-1280, -1560, -4170, -4280, -4290, -6860
Bearing: Cargo 140461



136577

Replacing 021401-3050, -3340, -3650
Servicing 100211-1031, -1074, -1091, -2001, -2050, -2080, -2102, -2410, -2451, -2500, -2510, -3020, -3170, -3260
Bearing: Cargo 140091 (42 mm)
Bearing Plate: Cargo 139935



136335

Replacing 021401-2931
Servicing 100211-1400, -1401, -1402
Bearing: Cargo 140084

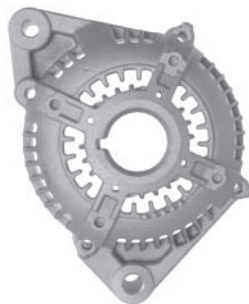

136562

Replacing 021401-4200
Servicing 100211-2550, -7500
Bearing: Cargo 140239



136754

Replacing 021401-5560
Servicing 100211-8150, -8170, -8190, -8260, -8790
Bearing: Cargo 140460

Replacing NIPPONDENSO



137366

Replacing 021401-5230
Servicing 100211-8030
Bearing: Cargo 140460



137431

Replacing 021400-1760
Servicing 021000-6611, -6612, -6631, -6642, -6643, -6711, -6712, -6732
W/ bearing



137651

Replacing 021401-7240
Servicing 101211-5130
Bearing: Cargo 140460



137419

Replacing 021401-3880
Servicing 100213-0451, -0710, -0740, -0745
Bearing: Cargo 140239



137449

Replacing 021400-2920, -8650
Servicing 100210-2600, -2750, -2820, -3040, -3250, -3270, -3360, -3400, -3460, -3580, -3680, -3770, -3810, -3820, -4240, -4250, -4260, -4280, 100213-0231, -0250
W/ bearing



137654

Replacing 021401-4900
Servicing 100211-8120
Bearing: Cargo 140460



137425

Replacing 021400-2290
Servicing 021000-5030, -5180, -7920, -7931, -7932, -7940, -7970, 7971, -8020, -8021, -8030
W/ bearing



137451

Replacing 021401-4021
Servicing 100211-1620, -4410
Bearing: Cargo 140461



137657

Replacing 021401-4911
Servicing 100211-4350, -4351
Bearing: Cargo 140461

Replacing NIPPONDENSO



137660

Replacing 021401-4030
Servicing 100211-4140, -4141
Bearing: Cargo 140461



137676

Replacing 021401-6950, -8020
Servicing 100211-8860, -8861, 101211-5720, -9240
Bearing: Cargo 140460



137685

Replacing 021401-5640
Servicing 100213-1130
Bearing: Cargo 140239



137661

Replacing 021401-5510
Servicing 100211-9190
Bearing: Cargo 140461



137681

Replacing 021401-4850
Servicing 100211-3321, -7460
Bearing: Cargo 140462



137804

Replacing 021401-5630, -5631
Servicing 100213-1030, -1040, -1140, -1790, -1910, -2250
Bearing: Cargo 140087



137673

Replacing 021401-5390
Servicing 100211-6200
Bearing: Cargo 140460



137683

Replacing 021401-5280
Servicing 100211-6730
Bearing: Cargo 140084



137806

Replacing 021400-3191
Servicing 100213-0300, -0610, -0750, -0760, -0850, -0860, -0950, -0960, -1120, -1210, -1450, -1500, -1560
W/ bearing

Replacing NIPPONDENSO



137972

Replacing 021401-5520
Servicing 100211-3980, -9410
Bearing: Cargo 140239



138748

Replacing 021400-2810
Servicing 100210-2840, -3280, -3720, 121000-1480, -2740, -8010
W/ bearing



139162

Replacing 021401-3951
Servicing 100211-1610, -1630, -1662, -1670, -4520, -4528, -4540, -4610, -4640, -4650, -4730, -4770
Bearing: Cargo 140084



138159

Replacing 021401-4121
Servicing 100211-2820, -2830, -2840, -2860
Bearing: Cargo 140460



139055

Replacing 021401-6040, -6041
Servicing 100211-8380, -8440, -8870, 101211-5460
Bearing: Cargo 140460



139178

Replacing 021400-1990, -1991
Servicing 021000-6670, -6671, -6800, -8230, -8231
W/ bearing



138677

Replacing 021400-0393, -1090
Servicing 021000-1603, -2840, -4550, -6840, -6940, -7250, -8130, -8140, -8620, -8640, -9561, -9590, 100211-0830, -0840, 121000-0600, -0920, -0980, -1340
W/ bearing



139078

Replacing 021400-2850
Servicing 021000-9980, 100210-2290, -2302, -2830, -2960, -2980, -3420, -4080, -4410, -4470, 100213-0540, -1840, 121000-0041, -1270, -1770, -2170, -5170
W/ bearing



139179

Replacing 021401-6630
Servicing 100211-9750, -9770, 101211-0230, -0240, -0250, -0300
Bearing: Cargo 140239

Replacing NIPPONDENSO



139180

Replacing 021400-2910, -8640
Servicing 100210-2350, -2360, -2660, -2700, -2810, -3080, -3350, -3660, -3760, -3840, -4220, -4230, -4270, -4290
 W/ bearing



139267

Replacing 021401-2840
Servicing 100211-1210, -1211, -1212
 Bearing: Cargo 140091



139491

Replacing 021401-4830
Servicing 100211-3352, -7000, -7050, -7051, -7052, -7270
 Bearing: Cargo 140462



139182

Replacing 021401-5270
Servicing 100211-8070, -8100, -8300, -8392, -8490, -8530, -8570, -8680, -8880, -8980, 101211,5280, -5340, -9180
 Bearing: Cargo 140460



139270

Replacing 021401-3131
Servicing 100211-1211, -1221, -1222, -1223, -1310
 Bearing: Cargo 140443



139891

Replacing 021401-3210
Servicing 100211-1470
 Bearing: Cargo 140084



139226

Replacing 021401-6830
Servicing 100211-8660, -8670, 101211-5020, -5240, -5380, -9280, -9500, 102211-1210
 Bearing: Cargo 140460



139272

Replacing 021401-3011
Servicing 100211-1200, -1230, -1260, -1270, -1320, -1350, -1370
 Bearing: Cargo 140443



139937

Replacing 021401-5380
Servicing 100211-7340, -7350
 Bearing: Cargo 140239

Replacing NIPPONDENSO



230048

Replacing 021400-2820
Servicing 021000-9850, -9851, 100210-2211, -2570, -2860, -2861, -2950, -2991, -4070, -4100, 121000-0670, -1710, -1910, -1930, 121000-8480, -8510
 W/ bearing



230299

Replacing 021401-6740
Servicing 100211-9800, 101211-0380, -0381
 Bearing: Cargo 140462

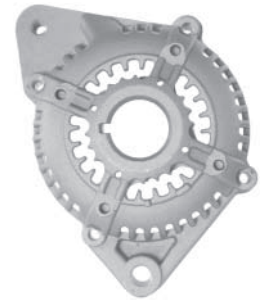

230572

Replacing 021401-4680, -4681
Servicing 100211-3300, -3310, -7760, -7770, -7810, -9980, 101211-0020, -0030
 Bearing: Cargo 140239



230154

Replacing 021400-2120, -2620
Servicing 021000-8500, -8770, -8780, -8830, -8840, -8890, -8892, -9680, -9690, 100210-1555, -1573, -1762, -1792, -1802, -2180, -2190, -2540, 121000-0610
 W/ bearing

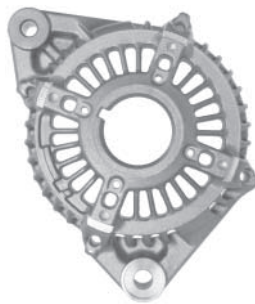

230469

Replacing 021401-7330
Servicing 101211-5480, -5490, -5500, -5850, -5870, -5890, Honda
 Bearing: Cargo 140084



230666

Replacing 021401-3850, -3851, -3852
Servicing 100210-3070, -3210, -3410, 100211-2661, -5000, -5140, -5141, -5280, 100213-0421, -0700, -0730, -1260, -1261, -2220, 121000-2140, -2550, -5120
 Bearing: Cargo 140239



230298

Replacing 021401-3870
Servicing 100211-2110, -2160, -3200, -3210
 Bearing: Cargo 141018



230495

Replacing 021401-6730
Servicing 101211-9790, 101211-0060, -0061, -0062, -0180, -0181, -0182
 Bearing: Cargo 140462



230771

Replacing 021401-1080
Servicing 021000-2422, -2522, -2532, -2542, -3021, -4630, -7000, -7040, -7310, -7320, -7590, -7600, 100210-0442, -1391, -1401, -1421, -1431, -1441, -1531, -1591
 Bearing: Cargo 140278

Replacing NIPPONDENSO



230862
Replacing 021401-5400, -5401
Servicing 100211-5031, 100213-1011
Bearing: Cargo 140087



231515
Replacing 021401-3760
Servicing 100211-1200, -1201, -1230, -1231, -1260, -1261, -1270, -1271, -1320, -1321, -1341, -1350, -1351, -1381, -2280
Bearing: Cargo 140239 (O.D. 46 mm)
Bearing plate: Cargo 139936



231770
Replacing 021401-3520
Servicing 100211-1440
Bearing: Cargo 140443



231232
Replacing 021401-6441
Servicing 102211-5120, -5200, -5220, 100213-1730, -1770
Bearing: Cargo 140239



231604
Replacing 021400-1940
Servicing 021000-8220, -8250, -8330, 121000-7030
W/ bearing



231785
Replacing 021401-4550
Servicing 100211-7320, 121000-2500
Bearing: Cargo 140239



231233
Replacing 021401-5980
Servicing 100211-6110, -6360
Bearing: Cargo 140460



231641
Replacing 021401-5570
Servicing 121000-4000*, -4010*, -4030*, -4040, -4050, -4060, -4070, -4080, -4090*, -4100, -4130, -4150*, -4160*, -4170*, -4270*, -4280*, -4290*, -4330*
**Use reduction bushing to convert Mtg. ear from 11 mm to 8 mm: Cargo 231677*
Bearing: Cargo 140460



232388
Servicing 121000-3000*, -3100*, -3300*, -3310*, -3330*, -3334*, -3360*, -3370, -3380, -3390, -3400, -3410, -3430, -3450, -3460
**Use reduction bushing to convert Adj. ear from 11 mm to 8 mm: Cargo 231677*
Bearing: Cargo 140460

Replacing NIPPONDENSO



233128

Servicing 100213-2350, -2351, 27040-54310
Bearing: Cargo 140087



234181

Servicing 100211-9880
Bearing: Cargo 140462



235062

Replacing 021401-8320
Servicing 102211-5052
Bearing: Cargo 140239



233549

Replacing 021401-8251
Servicing 102211-5280
Bearing: Cargo 140091



234566

Servicing 102211-8060, -8070, -8071, -8080
Bearing: Cargo 140093



235260

Replacing 021401-6453
Servicing 100213-2471
Bearing: Cargo 140239
Bearing plate: Cargo 230907



233704

Servicing 100211-6030, -6031, -6050, -6051
Bearing: Cargo 140460

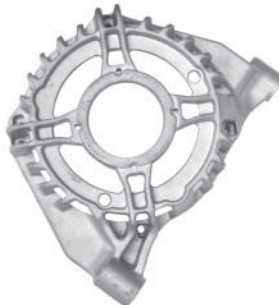

234638

Servicing 102211-8230
Bearing: Cargo 140093



235291

Servicing 102211-1950, -1960, -2770
Bearing: Cargo 140460



Replacing NIPPONDENSO

Brackets S.R.E.

237604

Servicing 104210-3521, -3522, -3511, -3512
Bearing: Cargo 141233
Bearing cap: Cargo 139936

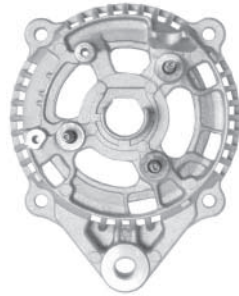

136147

Replacing 021501-4520, -4770, -4780
Servicing 100211-1040, -2001, -2031, -2050, -2070, -2080, -2102, -2130, -2140, -2150, -2190, -2410, -2451, -2470, -2500, -2510, -3050, -3090, -3170, -3180, -3240,
Bearing: Cargo 140237

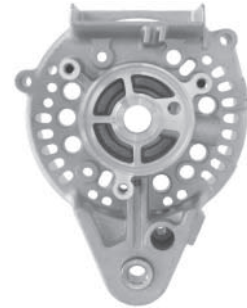

136563

Replacing 021500-4821
Servicing 100210-2600, -2750, -3040, -3250, -3270, -3360, -3400, -3460, -3580, -3680, 100213-0231, -0250, -0770, -0780
Seal set: Cargo 137803
Bearing: Cargo 140278

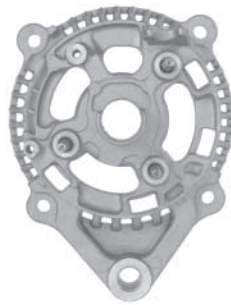

136148

Replacing 021501-4910, -6260
Servicing 100211-1341, -1351, -1381, -2250, -2280, -2300, -2340, -3500, -3510, -3530, -3560, -3610, -3680, -3700, -3740, -3980
Bearing: Cargo 140237



136567

Replacing 021501-4190
Servicing 100211-1200, -1201
Bearing: Cargo 140237



136394

Replacing 021501-5150, 8-94178603-0
Servicing 100211-2231, -2290
Bearing: Cargo 140237



136568

Replacing 021501-5680
Servicing 100211-1570, -6600, -6720
Bearing: Cargo 140441

Replacing NIPPONDENSO



136758

Replacing 021501-8130
Servicing 100211-8440, -8860,
 101211-5670, -5720
Bearing: Cargo 140237



137367

Replacing 021501-6560 
Servicing 100211-8030, -8350, -8480
Bearing: Cargo 140237



137430

Replacing 021501-2830
Servicing 021000-6611, -6612, -6631,
 -6642, -6643, -6711, -6712, -6732, -8340
Bearing: Cargo 140081



137294

Replacing 021501-6190
Servicing 100211-7000
Bearing: Cargo 140237



137418

Replacing 021501-4990
Servicing 100211-1440
Bearing: Cargo 140441



137432

Replacing 021501-2272
Servicing 021000-6610, -6630, -6640,
 -6710
Bearing: Cargo 140081



137296

Replacing 021501-5530
Servicing 100211-2550, -7500
 Honda
Bearing: Cargo 140237



137424

Replacing 021501-2880
Servicing 021000-5030, -5180, -7920,
 -7931, -7932, -7940, -7961, -7970, -7971,
 -7990, -8011, -8020, -8021, -8030, -9020,
 -9240
Bearing: Cargo 140081

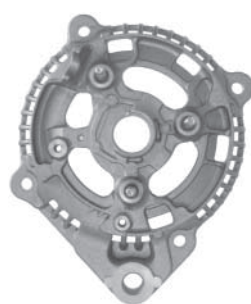

137649

Replacing 021501-6100
Servicing 100211-3310, -7770, -9980
Bearing: Cargo 140237

Replacing NIPPONDENSO



137652

Replacing 021501-6301
Servicing 100211-8120
Bearing: Cargo 140237



137665

Replacing 021501-3950, -4840
Servicing 100211-1001, -2021, -2040, -3060, -3100, -3150
Bearing: Cargo 140237



137680

Replacing 021501-6110, -6220
Servicing 100211-3321, -7460, 101211-0070
Bearing: Cargo 140237



137656

Replacing 021501-5250
Servicing 100211-4350, -4351
Bearing: Cargo 140441



137674

Replacing 021501-6690
Servicing 100211-6030, -6031, -6200
Bearing: Cargo 140237

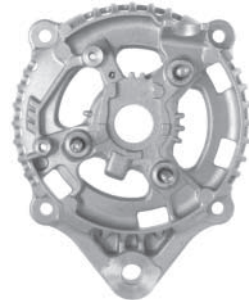

137686

Replacing 021501-6700
Servicing 100211-5970, 100213-1130
Bearing: Cargo 140237



137659

Replacing 021501-5330
Servicing 100211-4140, -4141
Bearing: Cargo 140441

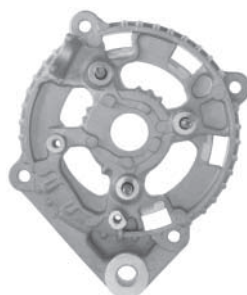

137678

Replacing 021501-6770
Servicing 100211-8150, -8151, -8710, 101211-5130
Bearing: Cargo 140237



137688

Replacing 021500-4680
Servicing 100210-2840, -3280, -3720, 121000-1480
Seal set: Cargo 137803
Bearing: Cargo 140278

Replacing NIPPONDENSO



137805

Replacing 021500-5072
Servicing 100213-0300, -0610, -0750, -0760, -0850, -0860, -0950, -0960, -1120, -1210, -1450, -1500, -1560
Seal set: Cargo 137803
Bearing: Cargo 140278



138160

Replacing 021501-5441
Servicing 100211-2820, -2830, -2840, -2860
Bearing: Cargo 140237

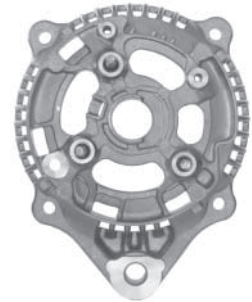

138749

Replacing 021501-6970
Servicing 100211-7640, -7780, -7910, 101211-0100
Bearing: Cargo 140237



137807

Replacing 021501-4360, -4361
Servicing 121000-0430, -0431, -0440, -0441, -2970, -7500
Bearing: Cargo 140081



138192

Replacing 021501-3691
Servicing 121000-1010, -1011, -1012
Bearing: Cargo 140081



138908

Replacing 021501-7950, -7960
Servicing 100211-8660, -8670, 101211-5020, -5240, -5380, -9280, -9500
Bearing: Cargo 140460



137808

Replacing 021501-8450
Servicing 101211-5120
Bearing: Cargo 140237

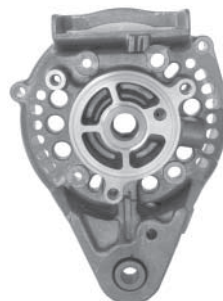

138678

Replacing 021501-4720, -5080, -5081
Servicing 100210-2280, -2560, -2700, -3080, -3350, -3660, -3760, -3840, 121000-0660, -0810, -0820, -2150, -2980, -7970, -8050, -8230
Seal set: Cargo 137803



139079

Replacing 021500-4690, -4691
Servicing 021000-9850, -9851, -9980, 100210-2211, -2290, -2570, -2950, -2960, -2991, -4070, -4080, -4100, -4410, 100213-0540, -1840, 121000-0670, -1710
Seal set: Cargo 137803

Replacing NIPPONDENSO



139080

Replacing 021501-4160, -4161
Servicing 021000-8270, -8310, -8311, 121000-7050
Bearing: Cargo 140081



139596

Replacing 021500-6081, 021501-7461
Servicing 100211-7861
Bearing: Cargo 140237



230156

Replacing 021501-4351, -4830
Servicing 100211-1400, -1401, -1402, -1420, -1451, -1452, -1453, -1460, -1461,
Bearing: Cargo 140272



139227

Replacing 021501-5280
Servicing 100211-1610, -1630, -1650, -1662, -1680, -1690, -4420, -4440, -4450, -4460, -4490, -4540, -4550, -4560, -4621, -4631, -4710, -4730
Bearing: Cargo 140441



230051

Replacing 021501-5240
Servicing 100211-2731, -5010, 100213-0451, -0710, -0740
Bearing: Cargo 140237



230238

Replacing 021501-6200, -6201
Servicing 100211-3091, -3181, -3391, -3401, -5021, -5040, -5050, -5090, -5130, -5210, -5230, -5231, -5250, -5251, -5310, -7090, -7100, -7110, -7130, -7140, -7170
Bearing: Cargo 140237

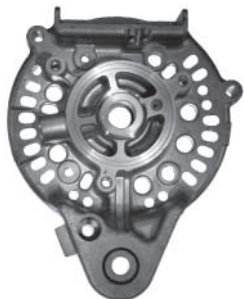

139350

Replacing 021500-4780
Servicing 100210-2302, -2830, -2980, 121000-0041, -1270, -1770
Seal set: Cargo 137803



230155

Replacing 021500-3881
Servicing 021000-8500, -8830, -8840, -8890, -8892, -9680, -9690, 100210-1555, -1573, -1583, -1762, -2180, -2190, -2540, 121000-0610

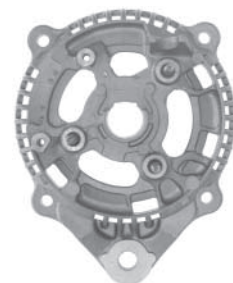

230300

Replacing 021501-5220
Servicing 100211-2110, -3200
Bearing: Cargo 140237

Replacing NIPPONDENSO



230301

Replacing 021501-7850
Servicing 100211-9800, 101211-0380, -0381
Bearing: Cargo 140237



230496

Replacing 021501-7840, -7841
Servicing 100211-9790, 101211-0060, -0061, -0062, -0180, -0181, -0182
Bearing: Cargo 140237



230770

Replacing 021500-1413
Servicing 021000-2422, -7310, 100210-0442, -1391, -1401



230470

Replacing 021501-2070
Servicing 021000-2991, -3040, -5490, -8610, -8620, -9561
Bearing: Cargo 140081



230667

Replacing 021501-5200
Servicing 100210-3070, -3190, -3210, 100211-2661, -5000, -5140, -5141, -5280, 100213-0421, -0700, -0730, -1260, -2220, 121000-2140, -2550, -5120
Bearing: Cargo 140237



231230

Replacing 021501-6580
Servicing 100210-3381, -3470, -3480, -3780, 100211-5150, -5290, 100213-1270, -2230, -2272, -2320, 121000-5081, -5380, -5490
Bearing: Cargo 140237



230471

Replacing 021501-8600
Servicing 101511-5480, -5490, -5500, -5850, -5870, -5890, Honda
Bearing: Cargo 140237



230670

Replacing 021501-9220
Servicing 100213-2471, 101211-0260, -0261, -0262, -0270, -0271, -0272, -0320, -0321, -0322, -0330, -0331, -0332, -0340, -0430, -0431, -0432, -0520, -0521, -0522
Bearing: Cargo 140237



231234

Replacing 021501-7190
Servicing 100211-6110, -6221, -6270
Bearing: Cargo 140237

Replacing NIPPONDENSO



231603

Replacing 021501-3781, -3783
Servicing 021000-8250, -8330
 Bearing: Cargo 140081



232392

Servicing 121000-3000, -3100, -3300, -3310, -3330, -3340, -3360
 Bearing: Cargo 140237



232395

Servicing 121000-4040, -4050, -4060, -4070, -4080, -4120, -4130, -4150, -4170
 Bearing: Cargo 140237



231769

Replacing 021501-5900
Servicing 100211-1670, -4520, -4528, -4610, -4640, -4650, -4770
 Bearing: Cargo 140441



232393

Servicing 121000-3370, -3380, -3390, -3400, -3410, -3430, -3440, -3450, -3460, -3470, -3530
 Bearing: Cargo 140237



233548

Replacing 021501-9731
Servicing 102211-5280
 Bearing: Cargo 140084

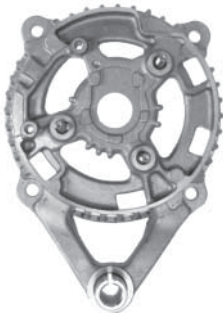

232389

Servicing 121000-3480, -3570, -3580
 Bearing: Cargo 140237



232394

Servicing 121000-4000, -4010, -4030, -4090, -4100
 Bearing: Cargo 140237



233707

Replacing 121501-0640
Servicing 102211-1680
 Bearing: Cargo 140237

Replacing NIPPONDENSO

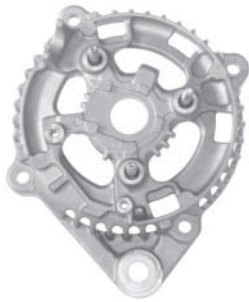

234538

Replacing 021501-8460
Servicing 101211-5130, -9360, -9520
Bearing: Cargo 140237



235061

Replacing 021501-9880
Servicing 102211-5090
Bearing: Cargo 140084



235125

Servicing 100211-1600, -1601, -4400
Bearing: Cargo 140411

235289

Replacing 121501-0780
Servicing 102211-1950, -1960, -2770, -2780
Bearing: Cargo 140237



236791

Replacing 021401-8780
Servicing 102211-5260, -5380, -5650
Bearing: Cargo 140084

Bracket Parts



133752 Std pkg 5

Replacing 021541-0721, 27351-64060
Servicing 100210-2760, 100213-0260, -0300, -0610, -0750, -0760, -0850, -0860, -0960, -1120
M10-1.25, L. 23 mm, O.D. 18.3 mm
Mounting bushing, S.R.E.



134276 Std pkg 10 A

10.5 x 17/22 x 15 mm
Mounting bushing, S.R.E.



134277 Std pkg 10 A

10 x 15 x 16.5 mm
Mounting bushing, S.R.E.



134278 Std pkg 10 A

8.5 x 15.3 x 15.3 mm
Mounting bushing, S.R.E.

Replacing NIPPONDENSO



135281 Std pkg 10
8.3 x 15/22 x 16 mm
Mounting bushing, S.R.E.



137452 Std pkg 5
Replacing 021045-0530
10.6 x 18.8/21 x 2.7 mm
Mounting bushing, D.E.



230716
Replacing 021411-0560
O.D. 59 x 59 mm
Bearing O.D. 52 mm
Bearing plate



137801 Std pkg 5
Replacing 021541-0630
15.65 x 18.55 x 15.25 mm
Mounting bushing, S.R.E.



231677
8 x 11 x 27.5 mm
Reduces Adj. ear hole from I.D. 11 mm to 8 mm
Bushing

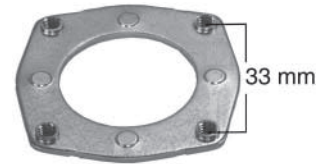

230907
Replacing 021411-0480
O.D. 48 x 48 mm
I.D. 30 mm
Bearing plate



231309
Replacing 021541-0581
10.1 x 18.3 x 15.4 mm
Mounting bushing, S.R.E.



139935
Replacing 021411-0400
O.D. 49 x 49 mm
Bearing O.D. 43 mm
Bearing plate



230996
Replacing 021411-0500
O.D. 43.6 x 44.9 mm
I.D. 28 mm
Bearing plate



231520 Std pkg 5
Replacing 021541-0321, -0790
8.4 x 13.4 x 15.4 mm
Mounting bushing, S.R.E.



139936
Replacing 021411-0450
O.D. 52.5 x 52.5 mm
Bearing O.D. 46 mm
Bearing plate



231104 Std pkg 5
Replacing 021411-0570
O.D. 61 x 61 mm
I.D. 37 mm
Bearing plate

Replacing NIPPONDENSO

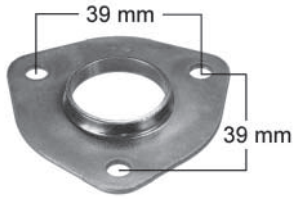

231517 Std pkg 5
Replacing 021411-0280
Servicing 021000-6940, -7370, -7700, -8140, -8610, -8620, -9510, -9561, -9590, 100211-0170, -0830, -0840, -0940, -0980
 I.D. 21 mm
 Bearing plate

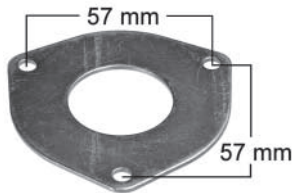

231518
Replacing 021411-0320
Servicing 021000-9850, -9851, -9861, -9930, -9931, -9960, -9980, 100210-2211, -2251, -2280, -2290, -2302, -2343, -2350
 I.D. 31 mm
 Bearing plate



231370
Replacing 021045-0060
 17 x 23/32.7 x 9.5 mm
 Spacer for bracket D.E.



231507
Replacing 021045-0470
 20 x 28.9 x 8.3 mm
 Spacer for bracket D.E.



139999 Std pkg 5
Replacing 021405-0160
Servicing 021000-9850, -9851, -9861, -9930, -9931
 O.D. 52 mm, I.D. 30 mm, Th. 0.63 mm
 Washer for bracket D.E.



232788 Std pkg 5
Replacing 021506-0070
 O.D. 22 mm, I.D. 15 mm, Th. 2.2 mm
 Washer, S.R.E. bearing (ext.)



232789 Std pkg 5
Replacing 021542-0160
 O.D. 26 mm, I.D. 15.4 mm, Th. 0.25 mm
 Washer, S.R.E. bearing (int.)



232790 Std pkg 5
Replacing 021542-0041
 24.5 x 35.2 mm
 Wave washer for S.R.E. bearing



236770 
Servicing 100211-2231, -2290, -3600, -3880, 102211-2810, 104210-3290, -3291, -3292, -3780
 40 x 45.6 x 1.5 mm
 Gasket



238687 
Replacing 949006-5200
Servicing 100211-1680, -4620, -4621
 M4 x 16 mm
 Screw

Replacing NIPPONDENSO

Covers



133674

Replacing 021551-0840, -0841, -0950
Servicing 100211-1001, -1011, -1021, -1031, -1041, -1061, -1091, -1121, -1141, -1171, -2001, -2021, -2031, -2050, -2071, -2080, -2102, -2110, -2130, -2140, -2150, -2160, -2170, -2190, -2410, -2451, -2470



136058

Replacing 021551-1210
Servicing 100211-1540, -4020, -4050, -4060, -4091, -6621, -6730, -6760, -6770, -6890, -6900, -6910, -9020, -9080, -9200, -9210, -9220, 101211-3000



136061

Replacing 021551-1480, -2050
Servicing 100211-8000, -8010, -8020, -8030, -8060, -8070, -8090, -8100, -8110, -8120, -8130, -8150, -8190, -8240, -8250, -8260, -8280, -8300, -8350, -8380, -8392, -8410, -8420, -8431, -8450, -8480, -8490



135967

Replacing 021551-1200
Servicing 100211-1600, -4540



136059

Replacing 021551-1190
Servicing 100211-1550, -1571, -4112, -4141, -4160, -4170, -4290, -4320, -4372, -6860, -6930, -6940, -6950, -6960, -6970, -9062, -9090, -9100, -9270, -9280, -9320, -9330, -9340



136062

Replacing 021551-1680, -2220
Servicing 100211-8230, -8330, -8340, -8470, -8500, -8590, -8810, -8820



136057

Replacing 021551-0850, -1170
Servicing 100211-1212, -1231, -1261, -1271, -1341, -1351, -1381, -2340, -3500, -3520, -3540, -3560, -3580, -3590, -3610, -3630, -3660, -3680, -3700, -3740, -3830, -3850, -3870, -3910, -9470, 100213-0740



136060

Replacing 021551-1251
Servicing 100211-3121, -3251, -3490, -7390, -7780, -7910



137664

Replacing 021551-2150
Servicing 100211-5210, -5230, -5250, -5310, -6190, -6200, -6210, -6221, -6330, -6350, -6410, -9940, -9950, 100213-1740, -1780, -1910, -2250, 101211-0050, -0070, -0140, -0170, -0180, -0210, -0220, -0260

Replacing NIPPONDENSO



137670

Replacing 021551-1510

Servicing 100211-6000, -6010, -6020, -6060, -6080, -6090, -6100, -6110, -6120, -6130, -6140, -6150, -6180, -6190, -6200, -6210, -6221, -6230, -6330, -6350, -6410



137862

Replacing 021551-0911

Servicing 100211-1070, -1071, -1073, -1074, -3020, -3380, -7012, -7950, -7951, -7952, -7990, 101211-0160



138414

Replacing 021551-1120

Servicing 100211-1511, -1512, -1580, -1590, -4000, -4001, -4002, -4003, -4004, -4080, -4103, -4104, -4120, -4180, -4190, -4191, -4200, -4201, -4210, -4220, -4230, -4240, -4250, -4360, -4361, -4362, -4383



137675

Replacing 021551-1840

Servicing 100211-5670, -5720, -8392, -8490, -8860



137863

Replacing 021551-1130

Servicing 100211-1610, -1630, -1650, -1662, -1680, -1690, -4460, -4482, -4490, -4550, -4560, -4621, -4631



138480

Replacing 021551-0610

Servicing 021000-7140, -7440, -7520

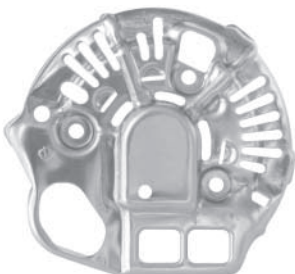

137687

Replacing 021551-2260

Servicing 101211-5000, -5010, -5020, -5100, -5110, -5120, -5130, -5150, -5170, -5200, -5220, -5230, -5240, -5260, -5300, -5370, -5380, -5390, -5470, -5610, -5630, -5640, -5660, -5670, -5720, -5760, -5770



138149

Replacing 021551-1070

Servicing 100211-2400, -2820, -2830, -2840, -2850, -2860



138907

Replacing 021551-2370

Servicing 101211-2130, -2190, -2230, -2570, -2620, -3030, -3160

Replacing NIPPONDENSO



138909

Servicing 121000-3000, -3100, -3300, -3310, -3330, -3360, -3370, -3380, -3390, -3400, -3430, -3440, -3450



231235

Replacing 021551-0251
Servicing 021000-7370, -8140, -9510, -9561, 121000-0551, -0552, -0561, -0580, -0590, -0600, -0980, -1000, -1001, -1340, -1350, -1750



231555

Replacing 021551-0800
Servicing 021000-7961, -7970, -7971, -7990, -8010, -8011, -9020, -9091, -9100, -9240, -9910, 121000-0411, -0420, -0470, -0471, -1540, -1541, -2620, -2630



230494

Replacing 021551-1050
Servicing 100211-1470



231248

Replacing 021551-1330
Servicing 100211-1670, -4520, -4528, -4610, -4640, -4650, -4770



231787

Replacing 021551-2460
Servicing 101211-5460



230669

Replacing 021551-2640
Servicing 100211-5210, -5310, 100213-1740, -2250, -2471, 101211-0050, -0051, -0052, -0060, -0061, -0062, -0070, -0071, -0072, -0140, -0170, -0171, -0172, -0180, -0181, -0182, -0210, -0211, -0260



231249

Replacing 021551-0860
Servicing 100211-1400, -1401, -1402



232791

Servicing 121000-4000, -4010, -4030, -4040, -4050, -4060, -4070, -4080, -4090, -4100, -4120, -4130, -4150, -4170

Replacing NIPPONDENSO



232792

Servicing 121000-3480, -3520, -3570, -3580



235271

Replacing 021551-2320
Servicing 101211-5570, -5571



237614

Servicing 104210-3511, -3512, -3761



232793

Replacing 021551-2450, -2580, -3780
Servicing 101211-5450, -5560, -5620, -5710, -9060, -9100, -9200, -9350, -9410, -9520, -9540, -9600, -9710, -9780, 102211-1920, -1960, -2000

236331

Servicing 104210-3050, -3051



237606

Servicing 104210-3522



235063

Replacing 021551-2630, -3920
Servicing 102211-5160



236792

Replacing 021551-3870
Servicing 102211-5260, -5380, -5650



Replacing NIPPONDENSO

Regulators

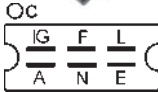
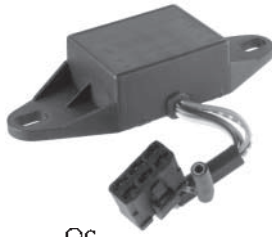

130615

Replacing 026000-1130, -1760, -1940
Servicing Mitsubishi
 12 V.
 Electronic

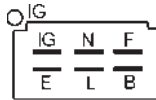

130627

Replacing 026000-1740, -1742, -1800
Servicing Daihatsu, Hino, Isuzu, Suzuki, Toyota
 12 V.
 Electronic. (In mechanic: Cargo 135661)

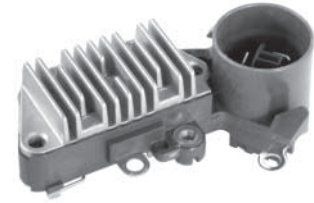

131459

Replacing 126000-0330, -0650, -0700
Servicing 100211-0120, -1051, -1080, -1081, -1121, -1180, -1320, -2050, -2060
 12 V.
 Terminals S-IG-L, L terminal drives choke
 Repair circuit: Cargo 133235



130621

Replacing 026000-0930, -3170, -4080
Servicing Daihatsu
 12 V.
 Electronic



130628

Replacing 026000-2340, -2580, -2900
Servicing Honda
 12 V.
 Electronic



131460

Replacing 126000-0180, -0520, -0770
Servicing 27040-54010, -64010, 27060-54010, -64030, 100213-0202, -0231, -0250, -0260
 12 V.
 Terminals S-G-F



130624

Replacing 026000-2930, -2940, -2960
Servicing Daihatsu, Toyota
 12 V.
 Electronic. (In mechanic: Cargo 132112)

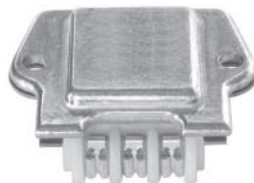

131288

Replacing 026000-0070
Servicing MD007100, MD661606
 12 V.
 Terminals F-L-LS

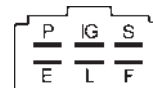

131461

Replacing 126000-0301, -0302, -0420
Servicing 31100-PC1-0041, -PC1-A9710
 Honda
 12 V.

Replacing NIPPONDENSO



131465

Replacing 126000-0030, -0140, -0141
Servicing 021000-7830, -8530, -8540, -8550, 100211-0211, -0240, -0300, -0310, -0330
 12 V.
 Terminals F-IG-B+

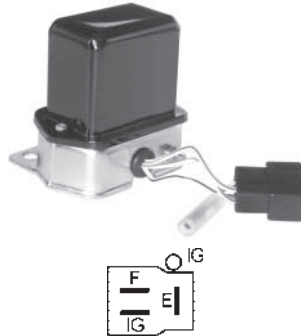

131492

Replacing 026000-2112, 27700-67211
Servicing Daihatsu, Toyota
 12 V.
 Mechanic

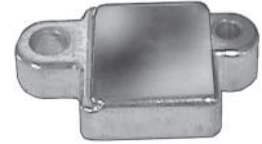

131527

Replacing 126000-0150, -0200, -0260
Servicing 100213-0151, -0171, -0520, -0540, -0560, -0720, -1070
 24 V.
 Terminals S-G-F

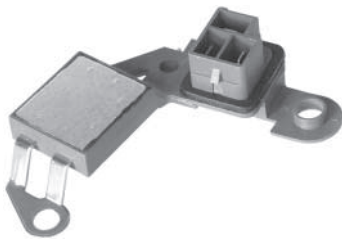

131466

Replacing 126000-0170, -0450, -0490
Servicing 27060-28030, -34040, -44010, -70060
 12 V.
 Terminals S-IG-L
Repair circuit: Cargo 133242



131493

Replacing 026000-3591, -3592, -3780
Servicing Toyota
 12 V.
 Mechanic



131530

Replacing 026000-2950
Servicing Toyota
 12 V.
 Electronic

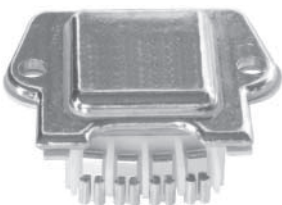

131467

Replacing 126000-0050, -0051, -0054
Servicing 100211-0071, -0081, -0280, -0290, -0291, -0292, -0790, -0995, -2950, 121000-2180, John Deere
 12 V.
 Terminals F-S-IG-Trio

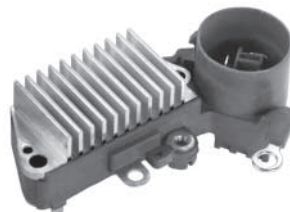

131526

Replacing 126000-0410
Servicing 100211-1410, -1411, -2200, -2201, -2320, -3800, -3860,
 12 V.
 Terminals D-IG-L, D = dummy terminal
Repair circuit: Cargo 133241



131531

Replacing 026000-3851
Servicing Toyota
 12 V.
 Electronic

Replacing NIPPONDENSO

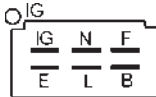

131532

Replacing 026000-1650, -2310, -2550
Servicing Toyota
 12 V.
 Mounting holes threaded
 Mechanic

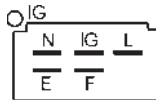

131536

Replacing 026000-1990
Servicing Isuzu
 12 V.
 Electronic

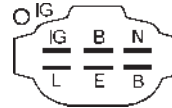

132112

Replacing 026000-3721
Servicing Daihatsu, Toyota
 12 V.
 Mechanic. (In electronic: Cargo 130624)

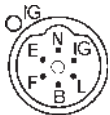

131534

Replacing 026000-2700
Servicing Isuzu
 12 V.
 Mechanic



131537

Replacing 026000-1862
Servicing Isuzu
 24 V.
 Mechanic



132627

Replacing 026000-4050, -4051, -4070
Servicing Toyota Diesel
 12 V.
 W/ capacitor and diode
 Mechanic

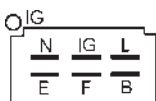

131535

Replacing 026000-2510
Servicing Isuzu
 12 V.
 Mechanic



132111

Replacing 026000-0400, -4200
Servicing Daihatsu, Hino, Isuzu, Suzuki, Toyota
 12 V.
 W/ diode
 Mechanic

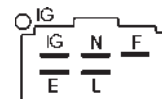

132628

Replacing 026000-1670, -1671, -2690
Servicing Toyota Diesel
 24 V.
 W/ diode
 Mechanic

Replacing NIPPONDENSO

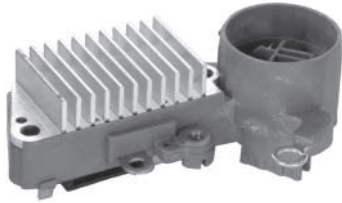

132645

Replacing 126000-0540, -1060
Servicing 100211-2010, -2550, -3310
 12 V.
 Terminals S-FR-IG-L
Repair circuit: Cargo 133239

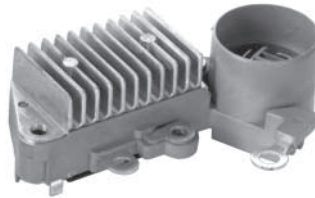

132855

Replacing 126000-0550, -0900, -0901
Servicing 100211-1520, -1560, -1620, -4170, -4350
 12 V.
 Terminals IG-S-L
Repair circuit: Cargo 133240

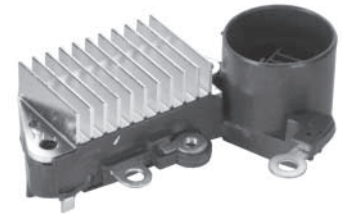

132860

Replacing 126000-0850, -0880, -1370
Servicing 100211-4140, -4141, -4710, -6600, 101211-2022, Isuzu
 12 V. Terminals IG-D-L
 The L-terminal drives the choke
Repair circuit: Cargo 133241



132646

Replacing 126000-0371, -0580
Servicing 100211-1402
 12 V.
 Terminals IG-L

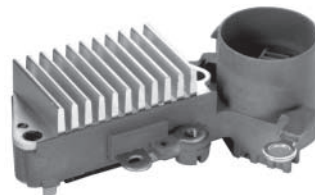

132856

Replacing 126000-0440
Servicing 100211-2340
 12 V.
 Terminals IG-C-L
Repair circuit: Cargo 133236



133206

Replacing 126000-0270
Servicing 100211-0421, -0422, -0580, -0991
 12 V.
 Terminals L-S-IG
Repair circuit: Cargo 133242

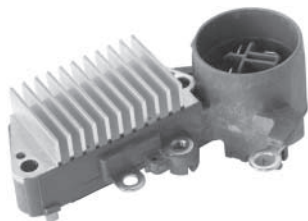

132831

Replacing 126000-0570
Servicing 100211-1350
 12 V.
 Terminals D-FR-IG-L
Repair circuit: Cargo 133238

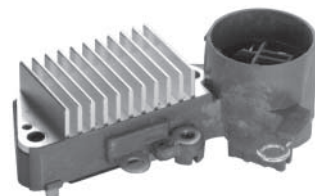

132859

Replacing 126000-0940, -1030, -1300
Servicing 100211-3590, -3660, -8740, 101211-5480, -5850, -5890
 12 V.
 Terminals IG-C-FR-L
Repair circuit: Cargo 133237



133256

Replacing 126000-0360, -0460, -0500
Servicing 100211-0730, -0760, -0870, -0930
 12 V.
 Terminals S-IG-L
Repair circuit: Cargo 133242

Replacing NIPPONDENSO

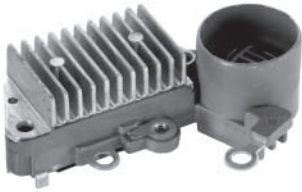

133257

Replacing 126000-0720, -0721
Servicing 100211-1550, -1570, -1571, -4070, -4130, -6720, -9190, -9310, -9320
 12 V. Terminals D-IG-L, The L-terminal does not drive the choke
Repair circuit: Cargo 133258

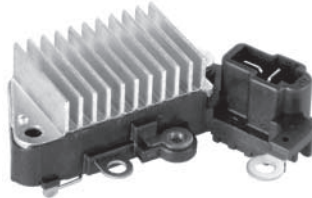

133872

Replacing 126000-0600, -1160
Servicing 100211-1511, -1540, -1580, -1590
 12 V.
 Terminals IG-L
 The L-terminal does not drive the choke
Repair circuit: Cargo 133259

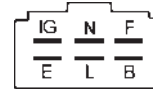

134858

Replacing 026000-3700, -3701, -3860
Servicing Daihatsu, Toyota
 12 V.
 W/ diode
 Mechanic



133519

Replacing 126000-0970
Servicing 100211-1662, -4210
 12 V.
 Terminals IG-L,
 The L-terminal drives the choke
Repair circuit: Cargo 135736

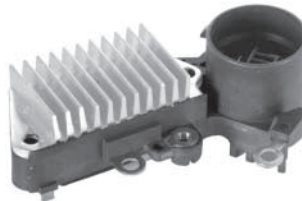

134447

Replacing 126000-0430, -1200
Servicing 100211-1270, -1380
 12 V.
 Terminals D-IG-L
 The L-terminal drives the choke
Repair circuit: Cargo 135735

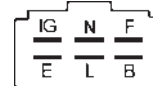

135376

Replacing 026000-3790, -3840, -3890,
 24 V.
 W/ diode
 Mechanic



133526

Replacing 126000-0920
Servicing 100213-0750, -0760, -0770, -0780, -0790, -0800, -0950, -0960, -0990, -1120, -1180
 12 V.
 Terminals L-S-IG

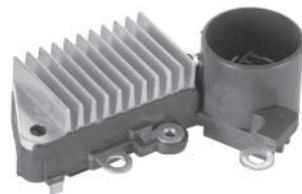

134700

Replacing 126000-2350, -7040
Servicing 100211-4540, -6930, -6931, -6960, -6961, -6970
 12 V.
 Terminals S-IG-L

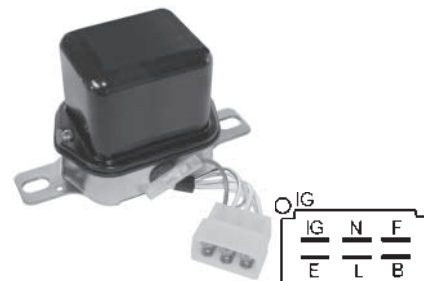

135661

Replacing 026000-1740, -1751, -1800
 12 V.
 Mechanic (*in electronic: Cargo 130627*)

Replacing NIPPONDENSO

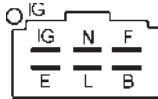

135662

Replacing 026000-2432, -3190, -3880
12 V.
Mechanic



135731

Replacing 126000-1260, -1270
Servicing 100211-5360, -6180, -6300,
-6330, -6340, -6360, -6400, -6410, -6420
12 V.
Terminals S-IG-L
The L terminal does not drive choke

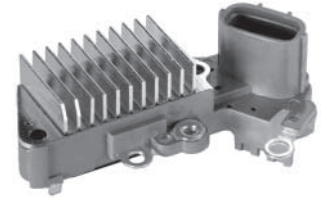

135737

Replacing 126000-1730, -1750
Servicing 101211-0120, -0190, -0340
12 V.
Terminals S-IG-L
The L terminal drives choke
Repair circuit: Cargo 133235

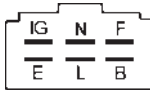

135663

Replacing 026000-3750, -3751
12 V.
Mechanic
Mounting holes threaded



135732

Replacing 126000-0020
Servicing 100211-0010, -0230, -0250,
Caterpillar
12 V.
Terminals F-IG-S

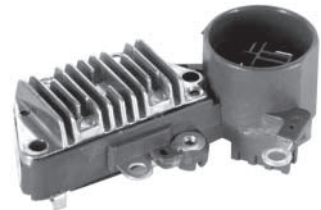

135739

Replacing 126000-1360, -1361
Servicing 100211-8600, -8601
12 V.
Terminals C-FR-IG-L
The L terminal does not drive choke



135730

Replacing 126000-0610, -1110
Servicing 100211-6110, -6180, -7470,
-7780, -7910, -7930, -7960, -8380, -8450
12 V.
Terminals S-IG-L
The L terminal does not drive choke

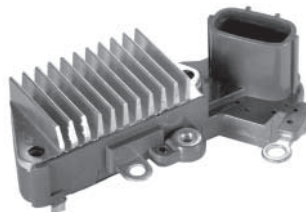

135734

Replacing 126000-1540, -1580, -1640
Servicing 100211-5020, -6440,
101211-0051, -0052, -0062, -0071, -0072,
-0381, -0680, -0681, -5100, -5910, -7160
12 V. Terminals S-IG-L
The L terminal does not drive choke



136727

Replacing 126000-1130, -1760, -7160
Servicing 100211-8370, -8630, -8631,
-8960, Volvo
12 V.
Terminal L

Replacing NIPPONDENSO

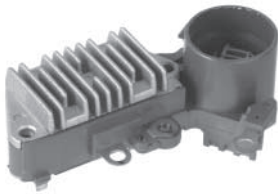

137395

Replacing 126000-7010, -7011
Servicing 100211-6200, -6210, -6221, -6230, -7170, -7370, -7380, -7670, -7850, -7880
 24 V.
 Terminal S-IG-L

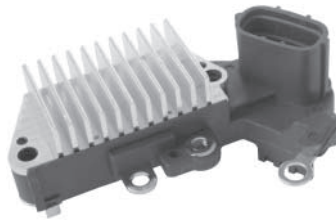

138638

Replacing 126000-1940
Servicing 101211-9010, -9020, -9940
 12 V.
 Terminal P-IG-L



138679

Replacing 126000-2330, -7000, -7001
Servicing 100211-5790, -5910, 100213-0820, -0830, -0840, -1880, -1890, 101211-6071, -6091, -6230, 121000-2770, -2780, -8640
 24 V.

Volt setting 14.6

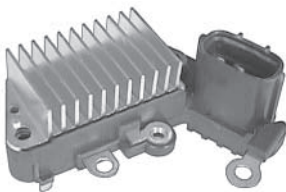

138146

Replacing 126000-1800
Servicing 101211-2310
 Caterpillar
 12 V.
 Terminal P-IG-L



138662

Replacing 126000-1630
Servicing 101211-2130, -3030
 12 V.
 Terminal S-IG-L
 57.5 mm between mtg. holes

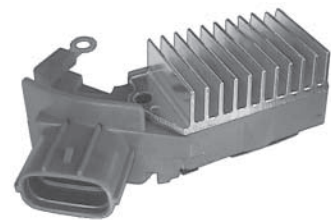

138894

Replacing 126000-1810, -1850, -1870
Servicing 100211-6470, 101211-5450, -5560, -7020, -7070, -7120, -7150, -7500, -9160, -9350, -9410, -9430
 12 V.
 Terminal S-IG-L



138297

Replacing 126000-7120
Servicing 100211-6240, -6250, -6260, -6270, 101211-0260, -0320, -0330, -0600, -0610
 24 V.
 Terminal S-IG-L

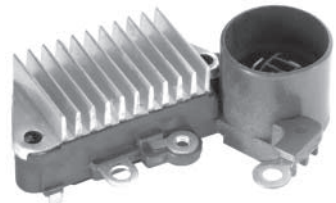

138664

Replacing 126000-0840
Servicing 100211-4111, -4112, -4150
 12 V.
 Terminal C-IG-L
 57.5 mm between mtg. holes

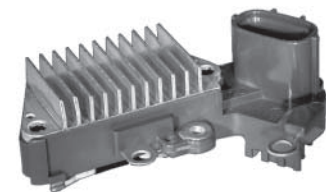

139268

Replacing 126000-1971
Servicing 101211-0550, -0551, -0722, -0723, -9180
 12 V.
 Terminal IG-L

Replacing NIPPONDENSO

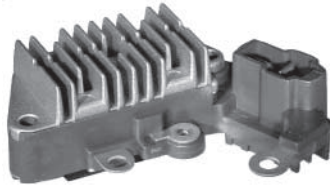

139419

Replacing 126000-0760, -0990
Servicing 100211-4020, -4490
 12 V.
 Terminal L-IG
 L - terminal drives choke



231197

Replacing 126000-1460
Servicing 100210-1560, 121000-5480
 12 V.
 Terminal L-S-IG
 W/ plug: Cargo 133526 or 234644



232474

Replacing 026000-4400, 31400-679-0030
Servicing Honda TA, TB, VD
 12 V.

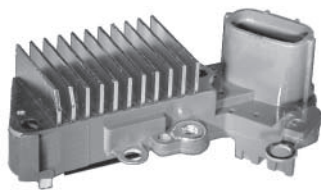

139584

Replacing 126000-1960, -2200
Servicing 100211-5220, -530, -5231, -5300, 5310, 100213-1780, -1781, -2240, -2250, 101211-0270, -0271, -0272, -0480
 12 V.
 Terminals S-IG-L



231462

Replacing 126000-2861, -3040
Servicing 102211-1680
 12 V.
 Terminal M-IG-L or L-IG-FR



232475

Replacing 126000-0661
Servicing 100210-3210
 12 V.



231060

Replacing 126000-0380
Servicing 100211-0860, -0890
 24 V.
 Repair circuit: Cargo 135733

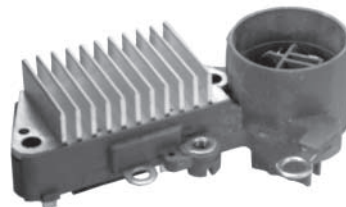

232455

Replacing 126000-1470
Servicing 100211-8910
 12 V.
 Terminal FR-D-IG-L
 L terminal drive choke
 12 sec. LRC.



232476

Replacing 126000-1340
Servicing Toyota
 12 V.

Replacing NIPPONDENSO



232477

Replacing 126000-1430
Servicing 100210-3700
 12 V.

Volt setting 14.5 V.



234091

Replacing 126000-3130, -3131, -3171
Servicing 102211-3130
 12 V.
 Terminal M-IG-L



234644

Replacing 126000-1460
 12 V.

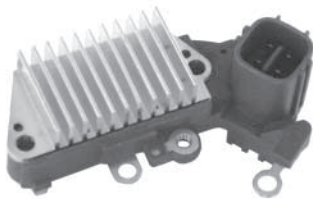

233517

Replacing 126000-2190
Servicing 101211-7230, -7270
 12 V.
 Terminals S-FR-IG-L



234322

Replacing 126000-8000
Servicing 101211-8000, -8001,
 27040-1970A, -1970B
 12 V.
 Terminal R-L-F-E-L-A-N

Volt setting 14.5 V.

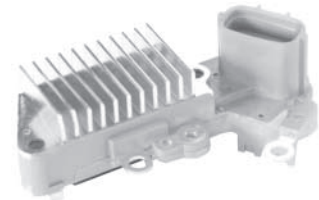

234731

Replacing 126000-2150, -2151
Servicing 101211-4220
 12 V.
 L terminal drives choke



233531

Replacing 026000-3450, -3650, -7010
 12 V.



234557

Replacing 126000-2090, -2160
Servicing 101211-7270, -9250, -9310,
 -9330, -9810, -9810, -9860, -9970, -9990,
 102211-1010
 12 V.

Volt setting 14.5 V.

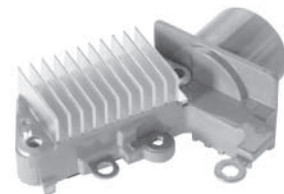

234732

Replacing 126000-1770
Servicing 100211-3020, -3021, -3380
 12 V.
 L-terminal does not drive choke

Replacing NIPPONDENSO

Regulator Parts

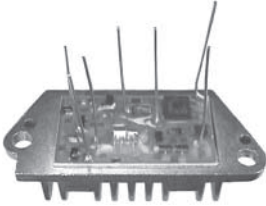

133235 A

Servicing 126000-0340, -0400, -0510, -0650, -0700, Cargo 131459
12 V.
Repair circuit w/ terminals S-IG-L

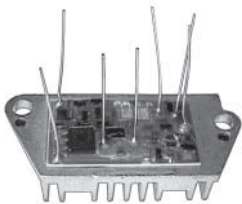

133236 A

Servicing 126000-0440, Cargo 132856
12 V.
Repair circuit w/ terminals IG-C-L

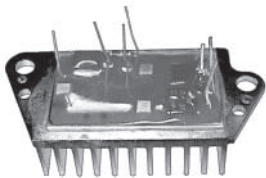

133238 A

Servicing 126000-0570, Cargo 132831
12 V.
Repair circuit w/ terminals D-FR-IG-L

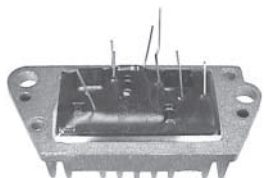

133239 A

Servicing 126000-0540, -1060, Cargo 132645
12 V.
Repair circuit w/ terminals S-FR-IG-L

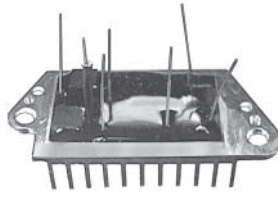

133240 A

Servicing 126000-0550, -0900, Cargo 132855
12 V.
Repair circuit w/ terminals IG-S-L

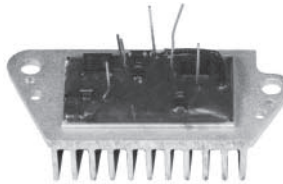

133241 A

Servicing 126000-0410, -0850, Cargo 132860, 131526
12 V.
Repair circuit w/ terminals D-IG-L

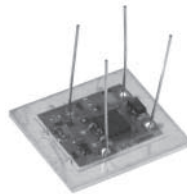

133242 A

Servicing 126000-0170, -0190, -0270, -0360, -0450, Cargo 131466, 133206, 133256
12 V.
Repair circuit w/ terminals S-IG-L

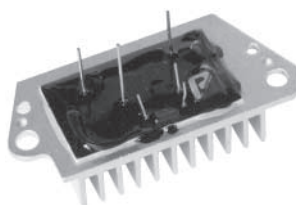

133258 A

Servicing 126000-0720, Cargo 133257
12 V.
Repair circuit w/ terminals D-IG-L
The L-terminal does not drive the choke

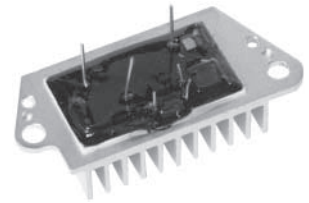

133259 A

Servicing 126000-0600, -0970, Cargo 133872
12 V.
Repair circuit w/ terminals IG-L

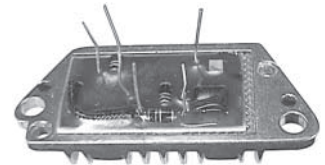

135023 A

Servicing 126000-0410, -1411, -4070, Cargo 131526
12 V.
Repair circuit w/ terminal D-IG-L



135733

Servicing 126000-0380, Cargo 231060
24 V.
Repair circuit w/ terminal B+ - D+ - F- B-

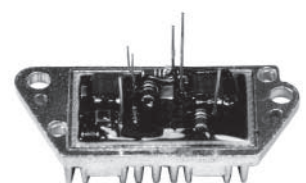

135735

Servicing 126000-0430, -1200, Cargo 134447
12 V.
Repair circuit w/ terminals D-IG-L

Replacing NIPPONDENSO

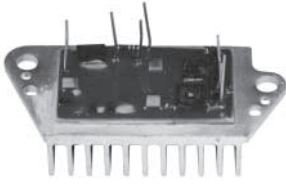

135736

Servicing 126000-0970, Cargo 133519
12 V.
Repair circuit w/ terminals IG-L



132862 Std pkg 5 A

Repair plug
3 prong
Used for repairing broken regulator housings



137207

Servicing 121000-3440, -3450, -4120
Insulator

Rectifiers



132082

Replacing 021580-2160, -2230, -2610
Servicing 100211-1000, -1001, -1011, -1021, -1031, -1041, -1061, -1091, -1121, -1141, -1171, -2001
O.D. 100 mm, 8 diodes
B+ terminal M6

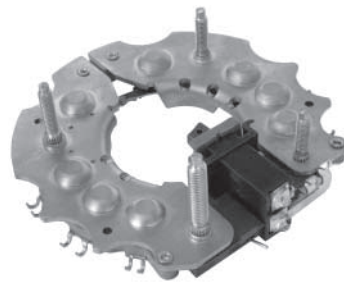

132086

Replacing 021600-1491, -1531, -1561
Servicing 100211-0540
O.D. 114 mm, 8 diodes, W/ diode trio



132540

Replacing 021580-3130, -3340
Servicing 100211-1520, -1550, -1560, -1570, -1580, -1600, -4080, -4103, -4120, -4140, -4160, -4170, -4180, -4190, -4200
O.D. 90 mm, 8 diodes
B+ terminal M6



132541

Replacing 021580-2250, -2260, -2330
Servicing 100211-1212, -1231, -1261, -1271, -1311, -1341, -1351, -1381, -1440, -2250, -2280, -2300
O.D. 90 mm, 8 diodes
B+ terminal M6



132647

Replacing 021580-1310, -1380, -2180
Servicing 100210-1573, -2030, -2080, -2211, -2280, -2290, -2302, -2490, -2560, 121000-0820, -1490
Negative part



132648

Replacing 021580-1370, -1560, -1590
Servicing 100210-1573, -2211, -2280, -2290, -2302, -2490, -2560, 121000-0820, -1490
Positive part

Replacing NIPPONDENSO



132649

Replacing 021580-2300
Servicing 100211-1721, -2750,
 100213-0231, -0250, -0300, -0610, -0850,
 -0860
 Positive part



132652

Replacing 021590-0560
Servicing 021000-3021, -7040, -7000,
 -7450
 41 mm between bolts
 Positive part



132657

Replacing 021590-1890, -1900, -1910
Servicing 100211-1573, -2211, -2280,
 -2302, -2570, 121000-0820
 O.D. 114 mm, 8 diodes
Brush box: Cargo 132084



132650

Replacing 021580-2571
Servicing 100213-0300, -0610, -0850,
 -0860
 4 diodes, 19 Ohm resistor. 3 Pin plug
 Negative part



132653

Replacing 021590-1710
Servicing 021000-8220,
 Positive part



133672

Replacing 021580-3830, -4080, -4480
Servicing 100210-3381, 100211-8010,
 -8020, -8030, -8060, -8070, -8090, -8130,
 -8300, -8380, -8392, -8420, -8430, -8490
 O.D. 103 mm, 8 diodes
 B+ terminal M6



132651

Replacing 021590-0530
Servicing 021000-3021, -7040, -7000,
 -7450
 30.5 mm between bolts
 Negative part

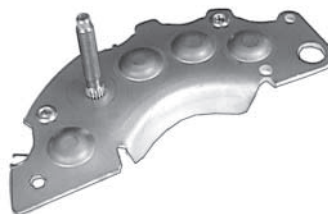

132654

Replacing 021590-1720
Servicing 021000-8220,
 Negative part



134306

Replacing 021580-3080, -3110
Servicing 100211-1601, -1610, -1620,
 -1630, -1640, -1650, -1661, -1662, -1680,
 -4400, -4410, -4440, -4450, -4460, -4482,
 -4490, -4500, -4530, -4540, -4550, -4560
 O.D. 83 mm, 8 diodes
 B+ terminal M6

Replacing NIPPONDENSO



135043

Replacing 021580-2950
Servicing 100211-2400, -2820, -2830, -2840, -2850, -2860, -6030, -6031
 O.D. 107 mm, 8 diodes
 B+ terminal M8 x 43 mm



135415

Replacing 021580-4120, -4490
Servicing 100211-8230, -8330, -8340, -8460, -8470, -8590, -8680, -8810, -8820
 O.D. 103 mm, 8 diodes
 B+ terminal M6

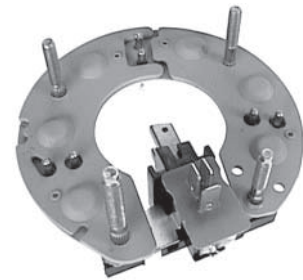

135884

Replacing 021600-1340, -1830
Servicing 021000-8400, -8410, -9040, -9050, -9051, -9091, -9100, -9910
 O.D. 100 mm, 6 diodes



135250

Replacing 021580-2511, -2512, -2521
Servicing 100211-3020, -3380, -7012, -7910, -7950, -7951, -7952, -7990, 101211-0100, -0160
 O.D. 100 mm, 8 diodes
 B+ terminal M6



135416

Replacing 021580-4820
Servicing 101211-7960, 121000-2430, -4000, -4010, -4030, -4040, -4050, -4060, -4070, -4080, -4090, -4130
 O.D. 110 mm, 8 diodes
 B+ terminal M6



136312

Replacing 021600-1381
Servicing 100211-0290, -0291, -0292, John Deere
 O.D. 114 mm, 6 diodes



135258

Replacing 021580-2340, -2341, -2342
Servicing 100211, -1224, -1251, -1330, -2221, -2231, -2290, -2391, -3640, -3650
 O.D. 90 mm, 8 diodes
 B+ terminal M6



135417

Replacing 021580-3640, -4660, -4840
Servicing 100211-8230, -8320, -8330, -8340, -8370, -8460, -8470, -8530, -8590, -8680, -8810, -8820, -8870, 101211-5220, -5460, -5550, 121000-3000
 O.D. 103 mm, 8 diodes
 B+ terminal M6



136741

Servicing 100211-8620, -8630
 Volvo
 O.D. 103 mm, 8 diodes
 B+ terminal M8

Replacing NIPPONDENSO



137375

Replacing 021600-1420, -1610
Servicing 021000-6611, -8230, -8231, 121000-1010, -1011, -1012
 O.D. 113 mm, 8 diodes
 B+ terminal M6



137874

Replacing 021580-4100, -4610, -5040
Servicing 100211-6090, -6110, -6120, -6130, -6140, -6150, -6180, -6190, -6330, -6350, -6410, -6440, -6460
 O.D. 113 mm, 8 diodes
 B+ terminal M8



138182

Replacing 021600-1840
Servicing 021000-8270, -8310, -8311, -8340
 O.D. 113 mm, 6 diodes
 B+ terminal M6



137671

Replacing 021580-3850, -4210
Servicing 100211-6200, -6210, -6221, -6230
 O.D. 113 mm, 8 diodes
 B+ terminal M6



137875

Replacing 021600-1540, -1581
Servicing 021000-8090, -9260, 100211-0040, -0400, -0430, -0720, 121000-0490
 O.D. 113 mm, 6 diodes



138772

Replacing 021997-1123
Servicing 021000-0814, -2840, -3061, -4550, -4570, -5450, -5600, -6840, -7250, -8120, -8130, -8140, -8610, -8620, -8640
 O.D. 106 mm, 6 diodes
 Brush box: Cargo 230165



137873

Replacing 021580-3450
Servicing 100211-1670, -4640, -4650, -4740, -4770
 O.D. 83 mm, 8 diodes
 B+ terminal M6



138168

Replacing 021600-1891
Servicing 021000-0441, 121000-0430, -0431, -0441
 O.D. 106 mm, 6 diodes
 B+ terminal M6

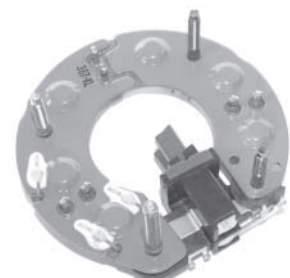

138773

Replacing 021600-1570
Servicing 100211-0421, -0422, -0440
 O.D. 106 mm, 6 diodes
 w/ Diode trio

Replacing NIPPONDENSO



230000

Replacing 021590-1990
Servicing 100213-0750, -0760, -0770, -0790, -0950, -0960, -1000, -1180, -1510
 O.D. 113 mm, 8 diodes
 B+ terminal M6
Brush box: Cargo 135226



232473

Replacing 021580-4810
Servicing 100211-6310, -6450

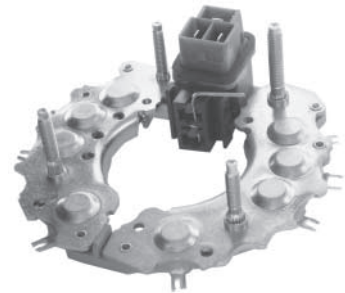

233249

Replacing 021600-1990
Servicing 021000-6150, -8200, 121000-0320



230671

Replacing 021580-5000
Servicing 100211-7050, -7051, -7052, 100213-2471, 101211-0050, -0051, -0052, -0060, -0061, -0062, -0070, -0071, -0072
 O.D. 100 mm
 B+ terminal M6



233246

Replacing 021580-4250, -4590, -5050
Servicing 100211-6160, -6170, -6430
 O.D. 113 mm
 B+ terminal M8



233888

Servicing 101211-0840, -4220



231236

Replacing 021580-5300
Servicing 102211-5090, -5160
 O.D. 100 mm
 B+ terminal M6

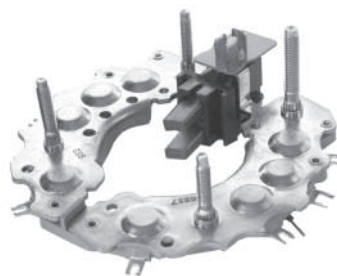

233248

Replacing 021600-1330
Servicing 021000-9120, -9130, -9140, -9820
 6 diodes, 30 Amp./200 V.

Replacing NIPPONDENSO

Rectifier Parts



136303 Std pkg 10
Servicing 021600-1491, Cargo 132086
 Insulator for diode trio

Slip Rings



131819 Std pkg 5 **A**
Servicing Honda, Toyota
 W/ internal fan,
 O.D. 14.9 mm, Shaft 9 mm, L. 24 mm



138438 Std pkg 5
 O.D. 33 mm, Shaft 17.3 mm, L. 25 mm



135173 Std pkg 10 **A**
 Same as 131819 but with 2 leaders
 O.D. 14.9 mm, Shaft 9 mm, L. 24 mm
Quick repair: Cargo 135610, 234489
 Must be wrenched off



234489 Std pkg 100
 13/15 x 9.4 mm
 Copper ring
Quick repair for slip ring: Cargo 131819, 135173, 135179, 230090



133408 Std pkg 5 **A**
 O.D. 33 mm, Shaft 18 mm, L. 25 mm
 Stainless steel



135315 Std pkg 10 **A**
 O.D. 33 mm, Shaft 17.5 mm, L. 31.1 mm
 Steel

Replacing NIPPONDENSO

Brush Boxes

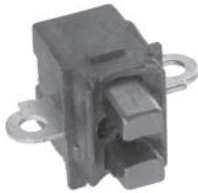

132084 A

Replacing 021620-2010, -2180, -2190
Servicing 100211-1000, -1001, -1320, -1321, -2050
 12 V. Complete w/ brushes



133673 A

Replacing 021620-2530, -2720
Servicing 27040-64030
 12 V. Complete w/ brushes



230165

Replacing 021620-0271, -0531, -0920
Servicing 021000-6850, -6851, -7370, -8140, -8610, -8620, -9561, -9590, 121000-0551, -0552, -0561, -0590, -0600
 12 V. Complete w/ brushes

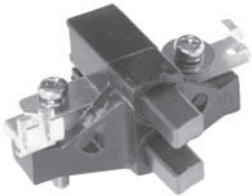

132555

Replacing 021620-0730, 27370-60080
Servicing 021000-7450
 12 V. Complete w/ brushes

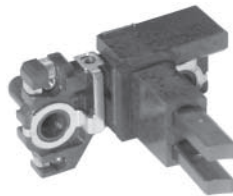

135226

Replacing 021630-0601, -0602
Servicing 100213-0750, -0760, -0770, -0780, -0790, -0800, -0950, -0960, -0990,
 12 V. Complete w/brushes



230166

Replacing 021630-0550, -0551, -0650
Servicing 021000-9881, 100213-0151, -0171, -0180, -0520, -0540, -0560, -0670, -0720, -1070, -1800, -1840, -1850, -1860
 12 V. w/ diode and resistor
 Complete w/ brushes



132556 A

Replacing 021620-1240, -1831, -2250
Servicing 100210-1573, -2302, -2660
 12 V. Complete w/ brushes



135419

Replacing 021630-0560
Servicing 121000-3000, -3100, -3300, -3310, -3330, -3360, -3370, -3380, -3390
 12 V. Complete w/ brushes



230683

Servicing 021000-3630, -3641, -5020, -5040, -5046 -5080, -5111, -5130, -5141, -5150, -5160, -5170, -5240, -5900, -5910, -5950, -5960, -6110, -6510, -6610, -6611
 12 V. Complete w/ brushes

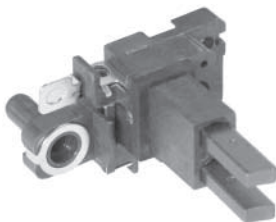

132558 A

Replacing 021630-0220, -0530
Servicing 100210-3381, 100213-1011, -1050, -1060, -1130, 100211-6000, -6010
 12 V. Complete w/ brushes

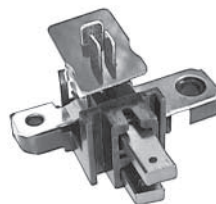

135640

Servicing 021000-8400, -8410, -9040, -9050, -9051, -9091, -9100
 12 V. Complete w/ brushes

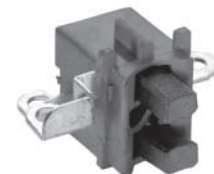

232456

Replacing 021620-2350
Servicing 121000-2430, -2660, -2680
 12 V.
 Complete w/ brushes

Replacing NIPPONDENSO

Brush Sets



140365 A

Replacing 021660-0130
5 x 8 x 17.6 mm
12 V.



140369 A

Replacing 021660-0311, -0530
5 x 8 x 25.8 mm
12 V.



140373

Replacing 021660-0080
5 x 10 x 18.5 mm
12 V.



140366

Replacing 021660-0060
5 x 10 x 18.5 mm
12 V.



140370 A

Replacing 021660-0370
5 x 8 x 19.5 mm
12 V.



140367 Std pkg 10 A

Replacing 021660-0320
4 x 5 x 17 mm
12 V.



140371 A

Replacing 021660-0390, -0510
5 x 7 x 14.3 mm
12 V.



140368 Std pkg 10 A

Replacing 021660-0330
5 x 8 x 20.3 mm
12 V.



140372

Replacing 021660-0040
5 x 10 x 18.5 mm
12 V.

Also see Bearing Chapter
page 821

Replacing NIPPONDENSO

Special Bearings



140236 A
Replacing 949100-2140
Servicing John Deere
 12/35 x 18 mm
 S.R.E.



140443 Std pkg 10 A
Replacing 949100-3190, 90099-10152
 15/43 x 13 mm



140960 Std pkg 10
Replacing 949100-4840
 8/28 x 9 mm



140237 Std pkg 8 A
Replacing 949100-2790, -3980
 15/35 x 13 mm
 S.R.E.



140460 Std pkg 8 A
Replacing 949100-3330, -4370
 17/52 x 16 mm



141018
Replacing 949100-3440
 15/43 x 24 mm



140239 Std pkg 10 A
Replacing 949100-3360, -3450, -4620
 15/46 x 14 mm
 D.E.



140461 Std pkg 12 A
Replacing 949100-3480
 15/38 x 19 mm



140441 Std pkg 10 A
Replacing 949100-3170, 90099-10154
 15/32 x 11 mm



140462 Std pkg 8 A
Replacing 949100-3820, -3821
 15/52 x 16 mm

Replacing NIPPONDENSO

Also see Pulley Survey page 809

Fan & Pulleys



139163

Replacing 021051-0430, -0490
Servicing 021000-7090, -7160
 O.D. 135 mm, Bore 20 mm
 Fan



231784

Replacing 021051-0360, -0550
Servicing 021000-2422, -2522, -2532, -2542, -4580, -4630, -5310, -5380, -7000, -7040, -7310, -7320, -7441, -7450, -7530,
 O.D. 141.5 mm, Bore 33 mm
 Fan



132836

Replacing 021041-3140
Servicing 021000-9770
 O.D. 71 mm, Bore 17 mm, W. 19.2 mm,
 3 grooves



231509

Replacing 021051-0880
Servicing 100210-2760, 100213-0260, -0300, -0610, -0750, -0760, -0850, -0860, -0950, -0960, -1120, -1210, -1450, -1500
 O.D. 139.5 mm, Bore 20 mm
 Fan



131204

Replacing 021041-2000, -2011
Servicing 021000-8140, 100211, -1410, -1540, -1550, -2201, -4060, -4070, -4150, -4710, -4780, -6830, 121000-0580, -1340
 O.D. 72.7 mm, Bore 15 mm, W. 20.6 mm,
 Single



133344

Replacing 021041-3380, -3960, -5160
Servicing 100211-1260, -1270, -1310, -1370, -2210, -3590, -4350, -6720
 O.D. 57.1 mm, Bore 15 mm, W. 21.4 mm,
 3 grooves



231551

Replacing 021051-0320
Servicing 021000-6940, -7700, -8140, -8610, -8620, -9510, 100211-0170, 121000-0551, -0552, -0580, -0600, -0980
 O.D. 118 mm, Bore 15 mm
 Fan



132834

Replacing 021041-3820, -4410, -5410
Servicing 100211-1030, -1031, -1090, -1091, -1150, -2060, -2061, -2080, -2160
 O.D. 60 mm, Bore 15 mm, W. 35.4 mm,
 7 grooves



133517

Replacing 021041-4260, -4300, -4540
Servicing 100211-1440
 O.D. 49 mm, Bore 15 mm, W. 22.7 mm,
 4 grooves



231664

Replacing 021051-0280, -0290, -0510
Servicing 021000-4510, -6610, -6611, -6612, -8420, -8870, -8910, -9020, 100211-0230, -0421, -0440, 121000-7010
 O.D. 135 mm, Bore 17 mm
 Fan



132835

Replacing 021041-3830, -3900, -4420
Servicing 100211-1000, -1001, -1060, -1061, -1140, -1141, -1230, -1231, -2020
 O.D. 53.4 mm, Bore 15 mm, W. 28.7 mm,
 5 grooves



133685

Replacing 021041-4670, 31141-PH1-004
Servicing 100211-2140, -2150, -3300, -3310, -7250
 O.D. 64.3 mm, Bore 15 mm, W. 29.5 mm,
 5 grooves

Also see Pulley Survey
page 909

Replacing NIPPONDENSO



133688

Replacing 021041-3410, 27411-54170
Servicing 100210-2600, -2700, -2750, -3040, -3080, -3250, -3270, 100213-0231
O.D. 67.1 mm, Bore 20 mm, W. 37.5 mm, Double



135458

Replacing 021041-3650
Servicing 121000-0430, -0441, -2970, -7050, -7500
O.D. 62.7 mm, Bore 17 mm, W. 23.8 mm, 4 grooves



135740

Replacing 021041-3641
Servicing 100210-2620
O.D. 59.2 mm, Bore 20 mm, W. 37.5 mm, 5 grooves



134325

Replacing 021041-2520
Servicing 021000-6190, -6520, -6560, -6750, 100211-0040, -0050, -0090, -0100
O.D. 71.9 mm, Bore 17 mm, W. 35.7 mm, Double



135510

Replacing 021041-4360, 028371-2600
O.D. 57 mm, Bore 17 mm, W. 24.1 mm, 3 grooves



135741

Replacing 021041-3350
Servicing 021000-8670, 121000-0561, -1590
O.D. 62.1 mm, Bore 15 mm, W. 26.3 mm, Single



134712

Replacing 021041-0821, -1740
Servicing 100211-0322, 121000-2030, -2110
O.D. 67.8 mm, Bore 15 mm, Single



135627

Replacing 021041-5230
Servicing 100211-4001, -4002, -4003
O.D. 76 mm, Bore 15 mm, W. 36.5 mm, Single, C-type belt



135850

Replacing 021041-3970, -4100, -4430
Servicing 100211-1010, -1011, -1020, -1021, -1100, -1101, -1130, -1131, -1160, -1161, -1170, -1171, -1250, -1251, -2020
O.D. 54.7 mm, Bore 15 mm, W. 19.7 mm, 4 grooves



135425

Servicing 021000-8260, -8261, -8262, -8290
O.D. 55.2 mm, Bore 17 mm, W. 20.4 mm, 3 grooves



135628

Replacing 021041-5890, -7370
Servicing 100210-3350, -3360, -3400, 100213-0990, -1180
O.D. 76.9 mm, Bore 20 mm, W. 45.5 mm, Double



136078

Replacing 021041-3260
Servicing 100210-2343, 100213-0201
O.D. 76.4 mm, Bore 20 mm, W. 35.9 mm, Single, B-type belt

Replacing NIPPONDENSO

Also see Pulley Survey page 809



136081

Replacing 021041-4741
Servicing 100211-1520, -1620, -4160, -4320, -4410
 O.D. 50.2 mm, Bore 15 mm, W. 25.7 mm, 5 grooves



136102

Replacing 021041-3791, -4980
Servicing 100210-2760, 100213-0260, -0300, -0600, -0750, -0850, -0950
 O.D. 74.5 mm, Bore 20 mm, W. 21.1 mm, Single, B-type belt



136453

Servicing 121000-3100, -3330, -3360, -3370, -3410, -4030, -4040, -4100
 O.D. 72.1 mm, Bore 17 mm, W. 34.1 mm, Double



136095

Replacing 021041-2780
Servicing 100210-1573
 O.D. 82 mm, Bore 19/25 mm, W. 23.4 mm, Single, B-type belt



136152

Replacing 081021-0060, -0070
Servicing 100210-3070, -3190, 100213-0421
 O.D. 74.4 mm, Bore 15 mm, W. 20.1 mm, Single, B-type belt



136454

Servicing 121000-3300, -3380, -3430, -4000, -4050
 O.D. 62.9 mm, Bore 17 mm, W. 23.9 mm, 4 grooves



136096

Replacing 021041-4960, -5700
Servicing 100211-1570, -1571
 O.D. 55 mm, Bore 15 mm, W. 23.4 mm, 4 grooves



136291

Replacing 021041-6501, -6830
Servicing 100213-1210, -1450, -1560
 O.D. 96.9 mm, Bore 20 mm, W. 18.1 mm, Single



136608

Replacing 021041-4790
Servicing 100211-2830, -2840
 O.D. 60.1 mm, Bore 17 mm, W. 28.6 mm, 5 grooves



136098

Replacing 081021-0100, -0131
Servicing 100210-3470, -3480, 100213-1260, -1270
 O.D. 86.1 mm, Bore 15 mm, W. 33 mm, Double



136452

Servicing 121000-3000, -3310, -3390, -4010, -4060
 O.D. 63.1 mm, Bore 17 mm, W. 28.4 mm, 5 grooves



137393

Replacing 021041-5950
Servicing 100211-7170, -7370, -7380
 O.D. 87.1 mm, Bore 15 mm, W. 24.4 mm, Single, C-type belt

Also see Pulley Survey
page 909

Replacing NIPPONDENSO



137650

Replacing 021041-7360
Servicing 101211-5130
O.D. 96.3 mm, Bore 17 mm, W. 21.3 mm,
Single



137666

Replacing 021041-3180
Servicing 100210-2840, -3720
O.D. 81.9 mm, Bore 20 mm, W. 25.4 mm,
Single, C-type belt



137689

Replacing 021041-4490
Servicing 100211-3160
O.D. 67 mm, Bore 15 mm, W. 19 mm,
Single



137655

Replacing 021041-5770
Servicing 100211-8120
O.D. 54.4 mm, Bore 17 mm, W. 27.7 mm,
5 grooves



137672

Replacing 021041-5970
Servicing 100211-6200
O.D. 96.7 mm, Bore 17 mm, W. 25.5 mm,
Single, C-type belt



137699

Replacing 081021-0090
Servicing 100211-5021, -5031, -5050,
-5070, -5080, -5090, 100213-0941, -1011
O.D. 74.6 mm, Bore 15 mm, W. 38.5 mm,
Double, B-type belt



137658

Replacing 021041-5190
Servicing 100211-4140, -4141
O.D. 68.9 mm, Bore 15 mm, W. 21.9 mm,
Single, B-type belt



137679

Replacing 021041-5400
Servicing 100211-3321, -7460
O.D. 54.7 mm, Bore 15 mm, W. 32.4 mm,
6 grooves



137959

Servicing 100211-8960
Volvo
O.D. 57.1 mm, Bore 17 mm, W. 46 mm,
6 grooves



137662

Replacing 021041-6230
Servicing 101211-0070
O.D. 52.4 mm, Bore 15 mm, W. 27.9 mm,
5 grooves



137682

Replacing 021041-5710
Servicing 100211-6730
O.D. 62 mm, Bore 15 mm, W. 29.4 mm,
Single



137961

Replacing 021041-2560
Servicing 021000-7310, -7320,
100210-0442, -1390, -1391, -1400, -1401
O.D. 82.4 mm, Bore 15/19.5 mm, W. 45.4
mm
Single, C-type belt

Replacing NIPPONDENSO

Also see Pulley Survey page 809



137967

Replacing 021041-3430
Servicing 100210-2302, -2980, -3420
 O.D. 81.7 mm, Bore 20 mm, W. 43.3 mm,
 Single, C-type belt



139345

Replacing 021041-3682, -4140
Servicing 100211-1400, -1401, -1610,
 -1630, -1650, -1670, -2330, -4080, -4120
 O.D. 62.9 mm, Bore 15 mm, W. 20.2 mm,
 Single



230525

Replacing 021040-0960, F-250051
Servicing Jaguar
 O.D. 58.7 mm, Bore 17 mm, W. 41.6 mm,
 6 grooves, w/ Free wheel
Pulley tool: Cargo 210843



137968

Replacing 021041-5170
Servicing 100211-1662, -1690, -4540
 O.D. 74 mm, Bore 15 mm, W. 22.9 mm
 Single, B-type belt



230314

Replacing 021040-0970, F-231108
Servicing Volvo
 O.D. 55.7 mm, Bore 17 mm, W. 41.1 mm,
 6 grooves, w/ Free wheel
Pulley tool: Cargo 210843



230530

Replacing 021041-6420
Servicing 100211-5870, 101211-6030,
 -6031, -6050, -6051
 O.D. 80.1 mm, Bore 17 mm, W. 44.5 mm,
 Double, B-type belt



137969

Replacing 021041-5240
Servicing 100211-4210, -6970
 O.D. 68.9 mm, Bore 15 mm, W. 30.5 mm,
 Single, B-type belt



230506

Replacing 021041-6640
Servicing 100211-7840, -7850, -7880,
 101211-0260, -0261, -0262, -0270, -0271,
 -0272, -0320, -0321, -0322
 O.D. 71.2 mm, Bore 15 mm, W. 32.3 mm,
 Double



230952

Replacing 021041-3010
Servicing 021000-9850, -9851, -9930,
 -9931, -9960, -9980, 100210-2211, -2251,
 -2280, -2290, -2860, -2861, -2950, -2960
 O.D. 92 mm, Bore 20 mm, W. 40.4 mm,
 Single, C-type belt



138973

Replacing 021041-5470
Servicing 101211-0430
 O.D. 59.9 mm, Bore 15 mm, W. 24.6 mm,
 4 grooves



230507

Replacing 021041-7580
Servicing 101211-0480, -0481, -0570,
 -0571, -0970, -0972
 O.D. 71.2 mm, Bore 15 mm, W. 36.8 mm,
 Double



230954

Replacing 021041-6780
Servicing 121000-3440, -3450, -3480,
 -3510
 O.D. 55.2 mm, Bore 17 mm, W. 30.4 mm,
 6 grooves

Also see Pulley Survey
page 909

Replacing NIPPONDENSO



230959

Servicing 102211-5160
O.D. 55 mm, Bore 15 mm, W. 23.6 mm,
4 grooves



230960

Replacing 021041-1310
Servicing 021000-3950
O.D. 71.9 mm, Bore 17 mm, W. 18.9 mm,
Single



231109

Replacing 021041-6680
Servicing 100211-6120, -6230, -6240,
-8410, 101211-5260, -5261, -7010, -7011
O.D. 76.6 mm, Bore 17 mm, W. 33.1 mm,
Double



231283

Servicing 100213-2320
O.D. 50 mm, Bore 15 mm, W. 31.5 mm,
6 grooves



231375

Replacing 021041-1831
Servicing 021000-6570, -7860, -8220,
-8231, 100211-0110, -0111, -0530, -0610,
-0630, -0720, 121000-0411
O.D. 74.5 mm, Bore 17 mm, W. 20.9 mm,
Single



231376

Replacing 021041-2240
Servicing 021000-8620, 121000-0980
O.D. 72 mm, Bore 15 mm, W. 23.2 mm,
Single, B-type belt



232163

Replacing 021041-6240, -6440, -7540
Servicing 100211-6060, -6330, -6350,
-6400, -6410, -6440, -6480, -8300,
101211-5620, -7140, -7170, -7180, -7200
O.D. 62.9 mm, Bore 17 mm, W. 32.1 mm,
6 grooves



232164

Servicing 121000-4080, -4090
O.D. 63.1 mm, Bore 17 mm, W. 37.7 mm,
8 grooves



232165

Replacing 021041-3100, -6950
Servicing 100211-8830, -8840,
100213-0720, 101211-5450, -5560, -5610,
-7760, -7800, -9150, -9160, -9350, -9410
O.D. 58.2 mm, Bore 17 mm, W. 31.9 mm,
6 grooves



232166

Replacing 021041-7110
Servicing 121000-3460, -3470, -4130
O.D. 64.4 mm, Bore 17 mm, W. 34.3 mm,
7 grooves



232338

Replacing 021041-4800
Servicing 100213-0520
O.D. 87 mm, Bore 25/18.5 mm, W. 36.3 mm,
27 splines,
Single, C-type belt



232343

Replacing 021041-7060
Servicing 101211-5110, 27060-62090
O.D. 59.4 mm, Bore 17 mm, W. 35.6 mm,
6 grooves

Replacing NIPPONDENSO

Also see Pulley Survey page 809



232347

Servicing 100211-8270, -8700
O.D. 69.6 mm, Bore 17 mm, W. 28.1 mm,
5 grooves



234025

Replacing 021041-8380
Servicing 101211-9520
O.D. 88.5 mm, Bore 17 mm, W. 21.2 mm,
Single

236763

Replacing 27415-30020 
Servicing 102211-2810
O.D. 58 mm, Bore 17 mm, W. 41.4 mm,
7 grooves, w/ Free wheel
Pulley tool: Cargo 210843



233944

Replacing 021041-5270
Servicing 102211-5020
O.D. 54.5 mm, Bore 15 mm, W. 24.9 mm,
4 grooves



234123

Servicing 100213-2530
O.D. 54.9 mm, Bore 15 mm, W. 35.5 mm,
7 grooves

236971

Servicing 102211-8220 
O.D. 53.7 mm, Bore 17 mm, W. 24.6 mm,
4 grooves



234019

Replacing 021041-5600
Servicing 100211-6110, -6360, -8380,
-8440, -8870, 101211-7060, 102211-1680
O.D. 54.1 mm, Bore 17 mm, W. 24.3 mm,
4 grooves



234220

Replacing 021041-6270
Servicing 100211-3980
O.D. 52.3 mm, Bore 15 mm, W. 26.3 mm,
4 grooves

237500

Replacing F-233106.1 
Servicing 100213-2950
O.D. 60 mm, Bore M14 mm, W. 38.5 mm,
6 grooves, w/ Free wheel
Pulley tool: Cargo 210843



234020

Servicing 102211-1461, -1650
O.D. 48 mm, Bore 17 mm, W. 29.2 mm,
5 grooves



234913

Replacing 021041-4630 
Servicing 100211-2231, -2290, -3020,
101211-4280
O.D. 68.8 mm, Bore 15 mm, W. 20.4 mm
Single

Replacing NIPPONDENSO



210843

Tool to be used for mounting and dismounting of free wheel pulleys
Shaft L. 74 mm.

210948

As Cargo 210843, but
Shaft L. 114 mm.

Fan & Pulley Parts



134273 Std pkg 10 A

O.D. 21.6 mm, Bore 15.5 mm, Th. 5.9 mm
Spacer



231602

Replacing 021045-0300
O.D. 28.9 mm, Bore 20 mm, Th. 7.2 mm
Spacer



136238 Std pkg 5

O.D. 22 mm, Bore 17 mm, Th. 9 mm
Spacer



233341 Std pkg 5

O.D. 47 mm, Bore 15 mm, Th. 14 mm
Spacer
Used w/ pulley: Cargo 132835, 133345



230995 Std pkg 5

Replacing 021045-0700
O.D. 28 mm, Bore 14 mm, Th. 8 mm
Spacer



234200 Std pkg 10

Servicing 021000-2991, -3040, -5490, -5600, -9561
O.D. 21.4 mm, I.D. 15.1 mm, Th. 9.5 mm
Spacer



231506 Std pkg 5

Replacing 021045-0011
O.D. 23-32.7 mm, Bore 17 mm, Th. 12 mm
Spacer

Replacing NIPPONDENSO

Vacuum Pumps



231402

Replacing 081000-1700
Servicing 100213-1040, -1050, -1230, -1240, -1250, -1730, -1740, -1920
 16 Splines



235064

Replacing 081000-1910
Servicing 100210-3670, -3680, -3810, 121000-1980, -1990, -8160
 10 Splines



Vacuum Pump Parts

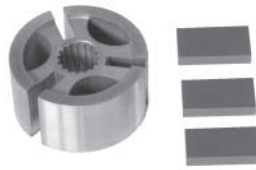

134395 A

Replacing 081200-0170
Servicing 081000-1321, -1480, -1611
 O.D. 44.2 mm, W. 23 mm, 16 splines,
 Rotor V.P.

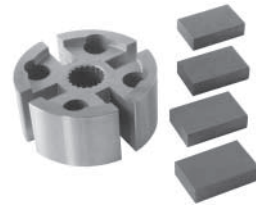

134396 A

Replacing 081200-0130
Servicing 081000-1491
 O.D. 50.3 mm, W. 23 mm, 18 splines,
 Rotor V.P.



139230

Replacing 081200-0220
Servicing 081000-1780, -1880, -1900,
 O.D. 50.4 mm, W. 23 mm, 10 splines
 Rotor V.P.
Vane set: Cargo 133282



230287

Replacing 081201-0090, -0091
Servicing 081000-0360, -0920
 O.D. 52 mm, W. 35 mm, 10 splines
 Rotor V.P.
Vane set: Cargo 133813



231231

Replacing 081200-0240
Servicing 100213-2320
 O.D. 44.2 mm, W. 23 mm, 16 splines
 Rotor V.P.
Vane set: Cargo 230321



231843

Replacing 081200-0210
Servicing 081000-1770, -1830, -1960, -2130, -2140
 O.D. 51.3 mm, W. 40 mm, 10 splines
 Rotor V.P.
Vane set: Cargo 135286



231859

Replacing 081200-0150
Servicing 081000-1360, -1500, -1510, -1520
 O.D. 51.3 mm, W. 40 mm, 18 splines
 Rotor V.P.
Vane set: Cargo 135286



133281 A

Replacing 081204-0070
 7.05 x 17.6 x 62 mm
 Rotor vane set

Also see Oil Seal Survey
page 856

Replacing NIPPONDENSO



133282 A

Replacing 081204-0110
6.1 x 14.8 x 23.1 mm
Rotor vane set



230321

Replacing 081204-0290
Servicing 081000-2272, -2430, -2440
5.06 x 12.70 x 23.00 mm
Rotor vane set



135136 A

Replacing 081220-0060
Servicing 081000-0821, 100210-1555, -1573
M14-1.5, L. 52.7, Spanner size 19 mm
Valve



133283 A

Replacing 081204-0240, -0250
4.1 x 12.7 x 23 mm
Rotor vane set



134293 A

Replacing 081221-0070
Servicing 081000-0360, -0920
M14-1.5, L. 42.2, Spanner size 27 mm
Valve



135366

Replacing 081220-0250
Servicing 081000-1480, -1610, -1611, -1630, -1660, -1700, -1740, -1760, -1970
M18-1.5, L. 37.6, Spanner size 24 mm
Valve



133813 A

Replacing 081204-0080
7.1 x 13.5 x 35.2 mm
Rotor vane set



134294 A

Replacing 081221-0110
Servicing 081000-0360, -0920
M14-1.5, L. 42.2, Spanner size 19 mm
Valve



137803 A

Replacing 081099-0090
Servicing 100210-2211, -2231, -2290, -2302, -2321, -2343, -2560, -2570, -2600
Oil seal 14 x 30 x 7 mm
Oil seal set



135286

Replacing 081204-0210, -0220
Servicing 081000-1260, -1360, -1500
6.08 x 15.1 x 40.0 mm
Rotor vane set



135135 A

Replacing 081220-0210
Servicing 081000-1030, -1041, -1050, -1070, -1080, -1151, -1170, -1260, -1360
M18-1.5, L. 41.7, Spanner size 24 mm
Valve



132549 Std pkg 10 A

Replacing 949150-0921
Servicing Toyota
15.5 x 30.1 x 7 mm
Oil seal

Replacing NIPPONDENSO

Also see Oil Seal Survey
page 856



133513 Std pkg 5 **A**
14 x 30 x 7 mm
Oil seal



135295 Std pkg 5
Replacing 081225-0030
Servicing 081000-0360, -1450, -1491
1/8"-36
Plug



230626
Replacing 081202-0120, -0150
Servicing 081000-1321, -1480, -1611, -1660, -1700, -1701, -1740, -1760, -1970, -2100, -2430, -2440
L. 116.3 mm, 16 splines
Shaft for vacuum pump



133523 Std pkg 5 **A**
Replacing 081103-0060
19 x 32 x 6 mm
Oil seal



080001 Std pkg 10 **A**
Replacing 949180-0490
M10-1.25
Hollow screws



230694 Std pkg 5
Replacing 081299-0020
Servicing 081000-1321, -1480, -1611, -1660, -1700, -1701, -1740, -1760, -1970, -2100, -2430, -2440
Washer for vacuum pump



133524 Std pkg 5 **A**
Replacing 081103-0080
17 x 30/37 x 8 mm
Oil seal



080255 Std pkg 10 **A**
M14-1.5
Hollow screw



134290 Std pkg 10 **A**
M12-1.5
Screw plug



230625
Replacing 081105-0040
Servicing 081000-1321, -1480, -1611, -1660, -1700, -1701, -1740, -1760, -1970, -2100, -2430, -2440
Cover for vacuum pump bearing

Replacing NIPPONDENSO

Sundry Parts



132065 Std pkg 5 **A**
Replacing 021626-0131
Servicing I.C. alternators w/ internal fan
 Seal for slip ring and brush box



233247
Replacing 021595-0010
Servicing 021000-6570, -6580, -7750, -7810, -7830, -7860, -7870, -7871, -7900, -7901, -8470, -8530, -8540, -8550, -8560
 Cover



134998
 3P - 3P Coupler, green



133679 Std pkg 5 **A**
Replacing 021626-0190, 27445-11010
Servicing 100210-3380, 100211-6000, -6010, -6020, -6090, -6100, -6200, -6210
 Seal



233330
Servicing 021620-2430, -2530, -2720, 021630-0560, Cargo 133673, 135419
 Cover for brush holder



135001 **A**
 3P - socket



133680 **A**
Replacing 021626-0250, 27388-42010
Servicing 100210-3381, 100211-6000, -6010, -6020, -6090, -6100, -6200, -6210
 Seal



233751
Replacing 021020-0340, 021021-0460
Servicing 100210-2343, -3871
 Cover



137802
Replacing 021700-2520
Servicing 100213-1560
 Connector



232629 Std pkg 5
 Seal
 Used w/ brush holder: Cargo 135419



133677 **A**
Replacing 021700-2300, 27379-64190
Servicing 100210-3381, -3410
 Wires



134367
Replacing 021650-0250, 27364-13110
Servicing 021000-8250, -8330
 Plug

Replacing NIPPONDENSO



134409 A

Replacing 021650-0190, 27364-13090
Servicing 021000-9260, 121000-0490
 Plug



234064

Servicing 021000-2840, -4550, -5670, -6370, -6840
 Insulator



234727

Servicing 421000-0011, -0012, -0013, -0021, -0022, -0023, -0024, -0030, -4590
 For ECU/PCM regulated units
 Terminal block



134720 A

Servicing alternators w/ internal fan
 3 pin
 Repair plug



231453

Servicing 121000-2430, -2680, -3000, -3100, -3300, -3310, -3330, -3360, -3370, -3380, -3390, -3400, -3430, -3450, -4000, -4010, -4030, -4040, -4050, -4060, -4070
 0.47 mf.
 Terminal block



132066 Std pkg 10 A

Replacing 021605-1360
Servicing I.C. alternators w/ internal fan
 L. 20 mm, W. 13 mm
 Insulator for stator lead



134721 A

Servicing alternators w/ internal fan
 4 pin
 Repair plug



231893

Servicing 121000-3480, -3490, -3510, -3520, -3570, -3580, -4160, -4210, -4260, -4330
 Terminal block



133676 Std pkg 5 A

Replacing 021605-1970, 27389-42010
Servicing 100210-3381, 100211-6000, -6010, -6020, -6090, -6100, -6200, -6210
 L. 20 mm, W. 13 mm
 Insulator for stator lead



134374 Std pkg 10 A

Servicing 121000-0451, -1010, -1011, -1012
 Insulator for plug

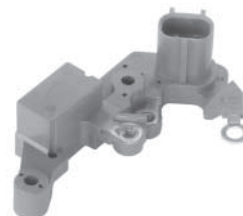

234501

Replacing 026220-0150
Servicing 121000-3620, -3630, -3670, -3671, -4231, -4232, -4233, -4250, -4251, -4290, -4400, -4450, -4451
 Terminal block



231639 Std pkg 10

L. 20 mm, W. 15 mm
 Insulator for stator lead

Replacing NIPPONDENSO



132067 Std pkg 5
Replacing 021605-1150, -1410, -1760
Servicing I.C. alternators w/ internal fan
 Bore 6 mm, L. 25 mm
 B+ Insulator



133525 Std pkg 5 **A**
Replacing 021605-1650, -1920
 Bore 6 mm, L. 28 mm
 B+ Insulator



134669 Std pkg 10 **A**
 Bore 8.3 mm
 Insulator



132783 Std pkg 10 **A**
Replacing 021605-0710
Servicing 021000-7971, -7990, -8011, -8021, -8231, -8311, -8330, 100211-0142, -0322, -0581, -0630, -0731, -0761, -0870
 Bore 5 mm, L. 13.5 mm
 Insulator



133915 Std pkg 10 **A**
Replacing 021605-2070, 27387-42020
 Bore 6/8, L. 24 mm
 B+ Insulator



135268 Std pkg 5
Replacing 021605-1320
Servicing 100211-1470, -2221, -2231
 Bore 6 mm, L. 19 mm
 B+ Insulator



132784 Std pkg 10 **A**
Replacing 021605-0301
 Bore 6 mm, L. 14.7 mm
 Insulator



134664 Std pkg 10 **A**
Replacing 021605-0510, 27387-45090
Servicing 100210-
 B+ Insulator



135273 Std pkg 5
Replacing 021605-1890, -1891, -1960
Servicing 100211-2390, -2391, -3120, -3121, -3230, -3231, -3250, -3251, -3490, -3650, -7390, -7640, -7780, -7910
 Bore 6 mm, L. 20.4 mm
 B+ Insulator



132785 Std pkg 5 **A**
Replacing 021605-1850, 27387-70170
 Bore 7 mm, L. 30.6 mm
 B+ Insulator



134668 Std pkg 10 **A**
Replacing 021605-0280, 27378-45020
 Bore 5 mm, L. 16.5 mm
 Insulator



135367 Std pkg 5
Replacing 021605-1670
Servicing 100211-2400, -2820, -2830
 Bore 8 mm, L. 35 mm
 B+ Insulator

Replacing NIPPONDENSO



137211

Replacing 021605-2350
Servicing 100211-6170
 Bore 8 mm
 B+ Insulator



231605 Std pkg 5

Replacing 021625-0220
 O.D. 22 mm, I.D. 8.8 mm, W. 2 mm
 Insulator



231768

Replacing 021605-1720
Servicing 100211-1540, -1670, -4020, -4050, -4060, -4091, -4520, -4528, -4610, -4640, -4650, -4770, -6621, -,6760, -6770
 L. 15 mm, I.D. 6.5 mm
 B+ insulator



139534 Std pkg 5

Replacing 021605-0661
 Insulator



231606 Std pkg 5

Replacing 021605-0291
 O.D. 7.3-16.4 mm, I.D. 5.1-13 mm,
 L. 15.3 mm
 B+ insulator



231786

Replacing 021605-2930
Servicing 102211-1680
 B+ insulator



230049

Replacing 021605-2020
Servicing 100210-3400, -3460, -3680, -3760, -3770, -3810, -3820, -3840, 100213-1180, -1510, -1560, -1720, 121000-5100, -5310, -5330, -5480, -7940
 B+ Insulator



231607

Replacing 021605-1700
 19 x 10.6-15.4 x 6 mm
 B+ insulator



232779 Std pkg 5

Servicing 121000-2430, -2660, -2680, -3000, -3100, -3300, -3310, -3330, -3340, -3360, -3370, -3380, -3390, -3400, -3410, -3430, -3460, -3470, -3530, -4000, -4010
 I.D. 6 mm
 B+ insulator



230860

Replacing 021605-2480
Servicing 100211-8230, -8330, -8340, -8460, -8470, -8500, -8590, -8810
 20.2 x 13-22.5 x 7 mm
 B+ Insulator



231640 Std pkg 5

L. 28 mm, I.D. 6 mm
 B+ insulator



232780 Std pkg 5

Replacing 021605-2420
Servicing 100211-8840, 121000-3480, -3490, -3520, -4160, -4330
 I.D. 6 mm
 B+ insulator

Also see O-ring Survey
page 854

Replacing NIPPONDENSO



232782

Replacing 021605-2150

Servicing 100211-5070, -5110, -5270, -6020, -6060, -6080, -6090, -6100, -6110, -6120, -6130, -6140, -6180, -6300, -6330, -6340, -6350, -6410, -6440, -6460, -6470
B+ insulator



232783

Replacing 021605-2360

Servicing 100211-7950, -7951, -7952, 101211-0160
I.D. 6 mm
B+ insulator



232784

Replacing 021605-2190

Servicing 100211-8230, -8320, -8330, -8340, -8810, -8820, -8870, 101211-5090, -5220, 121000-3510, -3570, -3580, -4210
I.D. 6 mm
B+ insulator



234234 Std pkg 5

Servicing 121000-3440, -3450, -4120
I.D. 6 mm
B+ insulator



234640

Servicing 104210-3170, -3240
Bore 14.6 mm, L. 35.7 mm
B+ insulator



230668

Replacing 021550-0390, 021551-1590
Servicing 100210-3381, -3470, -3480, -3780, 100211-5280, -5290, 100213-2220, -2230, 101211-9200, 121000-5081, -5380, -5490
Heat shield



232631 Std pkg 5

Replacing 021602-5230
Connector, rectifier to S.R.E. Cover



133040 Std pkg 10 A

Replacing 949140-3540
Servicing alternators w/ vacuum pump
56 x 2 mm, S.R.E.
O-ring



133597 Std pkg 5 A

64 x 2.5 mm
O-ring



133514 Std pkg 5 A

27 x 40 x 2 mm
Felt

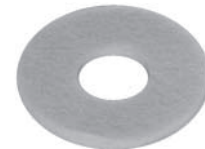

133527 Std pkg 5 A

15 x 36 x 2 mm
Felt



134760 Std pkg 10 A

35 x 50 x 5 mm
Felt

Replacing NIPPONDENSO



134767 Std pkg 10 **A**
15 x 45 x 5.0 mm
Felt



231516 Std pkg 5
Replacing 021405-0010
Servicing 021000-1603, -6940, -7370, -7700, -8140, -8610, -8620, -9510, -9561
ID. 21.4 / 27.5 mm, O.D. 28.8 / 34.8 mm, W. 0.5 / 1.4 mm
Washer



135493 Std pkg 5
M5-0.8 x 25 mm
KNURL O.D. 5.6 mm
Retainer stud



134766 Std pkg 10 **A**
15 x 41 x 1 mm
Rubber Gasket



133678 **A**
Replacing 021543-0020, 27351-64150
Servicing 100210-3070, -3190, -3210
M5 x 21 mm
Stud



232630 Std pkg 5
M5-0.8 x 36 mm
Stud for S.R.E. Cover



134768 Std pkg 10 **A**
12 x 22 x 2 mm
Fiber washer



139228
Replacing 021543-0140, -0170
Servicing 100211-5190, -8392, -8490
M5 x 22.25 mm
Stud



191528 Std pkg 100
Replacing 949007-1241
M5 x 95 mm, 30 mm thread
Thru bolt



230902 Std pkg 10
Replacing 949021-2100
Servicing 021000-7570, 100210-1550, -1552, -1553, -1572, -2210, -2250, -2340, -3400, -3460, -3680, -3760, -3770, -3810
51 x 22 x 1 mm
Gasket



139239
Replacing 021543-0030
M5 x 16.9 mm
Stud



136357 Std pkg 4
Replacing 949043-2000
M5 / M7 x 67 mm
Thru bolt

Replacing NIPPONDENSO



230997 Std pkg 2
Replacing 949043-2120
M5 / M6 x 65.9 mm
Thru bolt



231372 Std pkg 10
Replacing 949007-2040
M5 x 15 mm
Screw



231373 Std pkg 3
Replacing 949042-2330
M5 x 75/90 mm
Thru bolt



231629 Std pkg 3
Replacing 948042-0910, -2340
Servicing 021000-1603, -6940, -7370,
-7700, -7750, -8140, -8420, -8460, -8470,
-8610, -8620, -9510, -9561, -9590
M5 x 55/70 mm
Thru bolt



230861 Std pkg 10
Replacing 949006-5590
M5 x 18 mm
Screw for bearing plate D.E.

Replacing POONG SUNG

Rotor Parts



234546

Servicing 02131-9040, -9070
L. 209.6 mm, Shaft 17 mm, 16 Splines
Rotor shaft

236693

Servicing 02121-8025, -8027, -8070, -8071, -8073, -8074
L. 203.8 mm, Shaft 17 mm, 16 Splines
Rotor Shaft

Bracket Parts



238071

Servicing 02121-8025, -8027, -8070, -8071, -8073, -8074
Gasket S.R.E.
33 x 16.5 x 2 mm

Regulators

Volt setting 14.7 V.



139469

Servicing 02121-8025, -8027, -8070, -8071, -8073, -8074, -9012
12 V.



235035

Servicing 02131-9040, -9070
12 V.
Terminals L-F

Also see Bearing Chapter
page 821

Replacing POONG SUNG

Rectifiers

236466

Servicing 02121-8025, -8027, -8070,
-8071, -8073, -8074



Brush Boxes



235198

Servicing 02131-9110, -9111, -9112
12 V. Complete w/ brushes



236468

Servicing 02121-8025, -8027, -8070,
-8071, -8073, -8074
12 V. Complete w/ brushes



Special Bearings



141199

Servicing 02131-9040
17/52 x 15 mm
6304 DR bearing

Replacing POONG SUNG

Also see Pulley Survey
page 809

Fan & Pulleys



233990

Replacing F-233970.3
Servicing 02131-9110, 37300-27010
 O.D. 59.8 mm, Bore 17 mm, W. 35 mm,
 6 grooves, w/ Free wheel
Pulley tool: Cargo 210843



234673

Servicing 02131-9040, -9070
 O.D. 60 mm, Bore 17 mm, W. 25.5 mm,
 5 grooves

Vacuum Pump Parts



233915

Servicing 02131-9040
 16.01 x 18.54 x 15.03 mm
 Bushing for vacuum pump

235154

Servicing 021131-9110, -9111, -9112
 6 x 18.5 mm
 Rotor vane set

Sundry Parts



237688

Servicing 02121-8025, -8027, -8070,
 -8071, -8073, -8074
 15.8 x 30 x 7 mm
 Oil seal

Replacing PRESTOLITE

Rotors



132384

Replacing 10-311, -293, -309, ANB 1006B
Servicing ANB series
 24 V. 22 Amp.
 L. 216.3 mm, O.D. 88.1 mm, Shaft 22/25 mm

Stators



131872 Reman.

Replacing 13-187
Servicing ANB series
 24 V. 22 Amp.
 O.D. 126.7 mm, I.D. 88.8 mm, W. 34.4 mm

Brackets D.E.

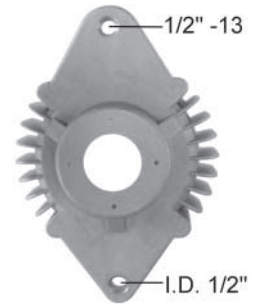

232396

Replacing 14-258, -270, ANB 1003
Servicing ANB series
Bearing: Cargo 140279



232397

Replacing 14-235, -263, -268
Servicing ALK 5001S, -5005A, -5101S, -5101S-1, -5101ST, -5201S, -6207, -6207S, -6210, -6210S, -6223, -6223S
Bearing: Cargo 140087

Replacing PRESTOLITE

Brackets S.R.E.



232398

Replacing 12-283, -306, ANB-2, -2BS
Servicing ANB series
Bearing: Cargo 140230

Regulators

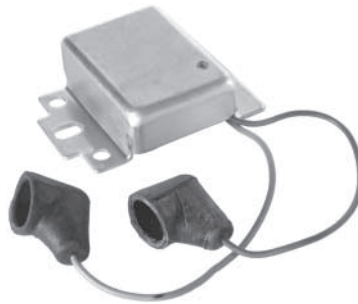

131687

Replacing VSH 6401C
Servicing ANB series
 24 V. green field, orange aux.

Rectifiers



131894

Replacing ANB 1024RS, 35-731
Servicing ANB series
 Negative



131688

Replacing VSH 6201B
Servicing ALE, ALK, ANC, ANK series
 12 V. green field, orange ignition
 Adjustable voltage



131895

Replacing ANB 1024SS, 35-732
Servicing ANB series
 Positive



131913

Replacing 8-352, VSH-620IN
Servicing ALE, ALK series
 12 V. green field, stud ignition



231224

Replacing 35-763, ALE 1054A
Servicing ALE, ALH, ALK, ALT, ALU, ALX, ALY, ALZ, ANC, ANE, ANG, ANK series
 Positive

Replacing PRESTOLITE

Slip Rings



133919 Std pkg 10
Servicing ANB series
 O.D. 35.5 mm, Shaft 17.5 mm, L. 21 mm

Brush Boxes



131921
Replacing 35-728, ANB-1015-1
Servicing ANB series
 24 V. Complete w/ brushes

Brush Sets



141179
Replacing 11-70, AMA-1012S
Servicing ANB series
 12 V.
 6 x 8 x 19 mm, LL. 26 mm

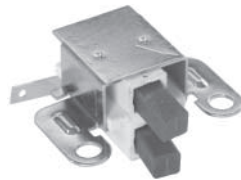

131922
Replacing 35-755, ALK 1020RS
Servicing ALE, ALK, ANE, ANC series
 12 V. Complete w/ brushes



141180
Replacing 11-73, ALE-1013C
Servicing ALE-, ALH-, ALK-, ANA-, ANC-, ANE-, ANK series
 12 V.
 6 x 6 x 12.5 mm, LL. 20 mm



EX91 2 Std pkg 10
Replacing ALA-1012CS
 6.3 x 6.3 x 12.7 mm
 12 V.

Replacing PRESTOLITE

Also see Bearing Chapter
and Pulley Survey

Roller Bearings



140230

Replacing 90-2058
Servicing ANB series
Outer race 19.05/31.75 x 19.05 mm
Inner race 12.7/19.05 x 25.4 mm

Fan & Pulleys



232117

Replacing 9S6129
Servicing ANB series, Caterpillar
O.D. 93.6 mm, Bore 22.23 mm (7/8"),
W. 93.3 mm,
Double, 22 mm belt



232118

Replacing 5S7609
Servicing ANB series, Caterpillar
O.D. 95 mm, Bore 22.23 mm (7/8"),
W. 82.9 mm,
Double, C-type belt



232167

Replacing 34-388, PU-598G
Servicing ALH-5307, -6306, -6322, -7606,
-7321, -7322
O.D. 78.3 mm, Bore 17 mm, W. 25.6 mm,
Single, C-type belt



232168

Replacing 34-399, PU-697
Servicing ANB-7003
O.D. 91 mm, Bore 22.23 mm (7/8"),
W. 46.2 mm,
Double, C-type belt

Repair Kits



231227

Replacing 90-2391
Servicing ANB series
Terminal kit for rectifier

Replacing PRESTOLITE

Sundry Parts



231225

Replacing 90-2164
Servicing ANB series
Retainer & seal kit for D.E. Bearing



231226

Replacing 90-2059
Servicing ANB series
Retainer & seal kit for S.R.E. Bearing



231228

Servicing ANB series
7 x 10 x 12.5 mm
Insulator

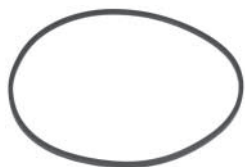

231229

Replacing 35-730A, ANB 61S
Servicing ANB series
Gasket for D.E. Bracket

Replacing ROMANIA

Rotors



132912

Servicing 1130, 1131, 1132
 12 V. 36 Amp.
 W/ S.R.E. bearing
 L. 153 mm, O.D. 89 mm, Shaft 20 mm

Regulators



130017

Replacing 1342
 12 V.
 Electronic, single phase

Brush Boxes



132911

Servicing 1130, 1132, 1158, 1159
 W/o brushes
 Brushes: Cargo 140447

Stators



132910

Servicing 1130, 1131, 1132
 12 V. 36 Amp.
 O.D. 127.7 mm, I.D. 88.5 mm, W. 22.4 mm

Rectifiers

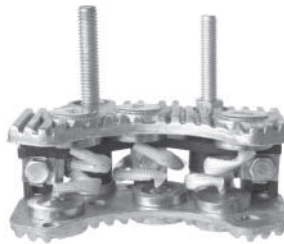

132129

Servicing 1130, 1132, 1158, 1159

Brush Sets



140447

Servicing 1130, 1131, 1132, 1158, 1159
 5.5 x 6.5 x 13.5 mm
 12 V.

Replacing SAWAFUJI

Rotors



136492

Replacing 1221-033-00X0
Servicing 0211 601 0113, -0135, -0136, -0163, 27020 1051, -1052, -1080, -1100
 24 V. 25 Amp.
 L. 183 mm, O.D. 110 mm, Shaft 25 mm



136497

Replacing 1221-004-00X0
Servicing 0211 401 0210, -0291, -2010, -2210, 27020 1010, -1380, -1820
 24 V. 15 Amp.
 L. 178.3 mm, O.D. 93 mm, Shaft 20 mm

Rotor Parts



136500

Replacing 1251-006-00X0
Servicing 0214 102 1412, -1422, -1512, -1522, -1612, -1712, 0214 152 0310, -0320, -0330, -0340, -0350, -0360, -0370
 24 V. 35/50 Amp.
 Rotor Coil

Stators



136487

Replacing 1211-011-00X0
Servicing 0211 601 0113, -0135, -0136, -0163, 27020 1051, -1052, -1080, -1100
 24 V. 25 Amp.
 O.D. 150.1 mm, I.D. 110 mm, W. 26.2 mm



136493

Replacing 1211-002-00X0
Servicing 0211 401 0210, -0291, -0510, -2010, -2210, 27020 1010, -1380, -1500, -1820
 24 V. 15 Amp.
 O.D. 131.8 mm, I.D. 93 mm, W. 21.2 mm



136498

Replacing 1211-206-10X0
Servicing 0214 102 1612, 27040 1141
 24 V. 35 Amp.
 O.D. 150.7 mm, I.D. 109.9 mm, W. 24 mm

Replacing SAWAFUJI



230900

Replacing 1211-328-00X0
Servicing 0214-501-0014, -0114, -0213, -0313, -0314, -0513
 24 V. 20 Amp.
 O.D. 131.1 mm, I.D. 93.1 mm, W. 21.2 mm

Regulators



133516

Replacing 1291-004-00X0
Servicing 0201-102-4015, 0201-152-0053, -0070, 0202-152-0210, -0220, -0310, 0214-102-1010, -1011, -1013, -1015, -1115
 24 V.
 Terminals R-L-F-C-E



138411

Replacing 1510-029-10X0
Servicing 0214-152-0210, -0230, -0260, -0271, -0281, -0290, -0411, -0420, -0430, -0440, -0610, -1010, Komatsu
 24 V.
 Terminal R-L-F-C-E

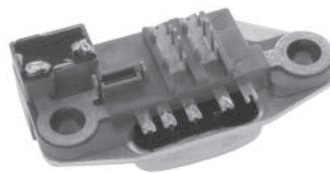

136167

Replacing 1291-007-00X0
Servicing 0201-102-1710, -2020, -2610, 0202-102-1211, -1310, -1411, -1510
 24 V.
 Terminals L-F-C-E

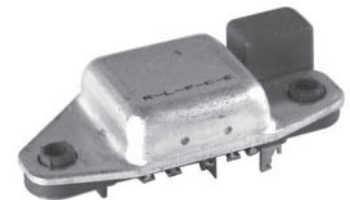

231727

Replacing 1291-006-00X0
Servicing 0201-102-1010, -1011, -1110, -1111, -1810, -1910
 24 V.
 Terminals: R-L-F-C-E

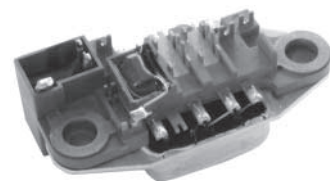

136168

Replacing 1291-008-00X0
Servicing 0201-102-2710, -2810, -2910, -2921, -2940, -3014, -3024, -3033, -3115, -3214, 0201-172-0016, -0115, -0124, -0210
 24 V.
 Terminals R-L-F-E-LA-N



233493

Replacing 1291-010-00X0
Servicing 0201-152-0114, -0214, -0310, -0410, -0420, -0713, -0811
 24 V.
 Terminals N-L-LA-T

Replacing SAWAFUJI

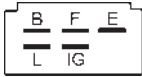

233735

Replacing 0514-030-0610
24 V.

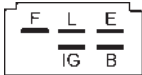

233736

Replacing 0514-050-0411
24 V.



234275

Replacing 1291-006-10X0
Servicing 0201-102-2310, -2410
24 V.
Terminals L-F-C-E

Rectifiers



136488

Replacing 1235-002-00X0
Servicing 0211 102 0012, -0022, -0232,
-3210, -4210, -4310, -4320,
0211 601 0113, -0135, -0136, -0163,
0214 102 0011, -0021, -0511
Positive



136495

Replacing 1235-001-00X0
Servicing 0211 401 0210, -0291, -0510,
-2010, -2210, 0211 601 0015, -0025,
-1510, 23100 96102, -96302, -97003,
27020 1010, -1380, -1500, -1820
Negative



136489

Replacing 1235-003-00X0
Servicing 0211 102 0012, -0022, -0232,
-3210, -4210, -4310, -4320,
0211 601 0113, -0135, -0136, -0163,
0214 102 0011, -0021, -0511
Negative

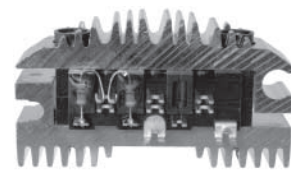

136499

Replacing 1235-055-10X0
Servicing 0214 102 1612, -1712,
27040 1141, -1151



136494

Replacing 1235-000-00X0
Servicing 0211 401 0210, -0291, -0510,
-2010, -2210, 0211 601 0015, -0025,
-1510, 23100 96102, -96302, -97003,
27020 1010, -1380, -1500, -1820
Positive

Replacing SAWAFUJI

Brush Boxes



136490

Replacing 1231-000-20X0
Servicing 0211 102 0012, -0022, -0232, -4310, -4320, 0211 401 0210, -0291, -0510, -2010, 0211 601 0113, -0135, -0136,
 24 V. Complete w/ brushes

Brush Sets



140819

Replacing 2660-001-10X0
 6 x 6 x 19 mm
 24 V.



140820

Replacing 2660-001-20X0
 6 x 6 x 19/18 mm
 24 V.



140821

Replacing 2660-014-01X0
 6 x 22 x 22.5/20 mm
 24 V.

Replacing SEV

Rotors



130901

Replacing 711 51203
Servicing 712 12602, -12702, -51203,
-71302, 713 12002
12 V. 55 Amp.
L. 144.5 mm, O.D. 89 mm, Shaft 17 mm



131076

Replacing 711 51903
Servicing 715 43102
24 V. 45 Amp.
L. 157 mm, O.D. 88 mm, Shaft 17 mm

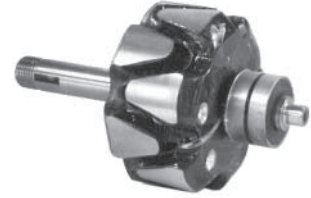

131970

Replacing 711 54303
Servicing 716 51902
12 V. 50 Amp.
L. 156 mm, O.D. 88 mm, Shaft 17 mm

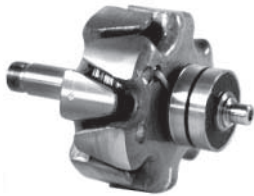

130921

Replacing 711 51603
Servicing 712 70002, -70202
12 V. 30-40 Amp.
L. 134 mm, O.D. 88 mm, Shaft 17 mm



131645

Replacing 711 53403
Servicing 716 55002, -55102
12 V. 55 Amp.
L. 136 mm, O.D. 89 mm, Shaft 17 mm



131041

Replacing 711 52003
Servicing 713 40102, -40202
24 V. 35 Amp.
L. 147 mm, O.D. 88.5 mm, Shaft 17 mm



131967

Replacing 711 53803
Servicing 717 70002, -70102, -70202
12 V. 80 Amp.
L. 144.5 mm, O.D. 100 mm, Shaft 17 mm

Replacing SEV

Rotor Parts



131822 Std pkg 10 **A**
Rotor shaft nut, fine threaded



132080 Std pkg 10 **A**
M17-1.5
Rotor shaft nut set



132324 Std pkg 10 **A**
4 x 6.5 x 16 mm
Key



234710
Servicing 71655002
6.75 x 15.3 x 1.45 mm
Washer



Stators



130133
Replacing 711 10603
Servicing 712 10502, -29202, -70002, -70202
12 V. 40 Amp.
O.D. 127.3 mm, I.D. 88.9 mm, W. 18.8 mm



130273
Replacing 711 10503
Servicing 712 12602, -71302, 713 12002
12 V. 55 Amp.
O.D. 127.7 mm, I.D. 88.4 mm, W. 25.5 mm



130274
Replacing 711 10903
Servicing 712 40002, 713 40102, 714 93502
24 V. 35 Amp.
O.D. 127.1 mm, I.D. 89 mm, W. 18.7 mm



131061
Replacing 711 11103
Servicing 713 36002, -36101, 715 43102
24 V. 45 Amp.
O.D. 127.3 mm, I.D. 89 mm, W. 26.2 mm



131129
Replacing 711 11003
Servicing 712 43002, -49002, -93402, -93452, -93502, 713 40002, -90502, -90602, -90702, -90802, -93402
24 V. 27 Amp.
O.D. 127.5 mm, I.D. 88.5 mm, W. 19 mm



131982
Replacing 711 11703
Servicing 717 70002, -70102, -70202
12 V. 80 Amp.
O.D. 135.8 mm, I.D. 99.5 mm, W. 27.9 mm

Replacing SEV

Bracket Parts



139583

Replacing 719 98003
Servicing 716 36202, -302, -802, -902
 Mounting bracket



131608 A

Servicing 702 20002, -20502,
 712 27102, -27902, -30202
 Bracket mounting bushing kit



131827 Std pkg 5 **A**

Replacing 719 97103
Servicing 6200
 I.D. 30 mm, O.D. 31.7 mm, W. 13.4 mm
 Bearing cap S.R.E.

Covers



131624

Replacing 719 97003
Servicing 716 35202, -50402

Regulators



130015

Replacing 722 29002, 726 20502
 24 V.
 4 terminals



130679

Replacing 727 10202
 12 V.
 Electronic



130926

Replacing 725 90302
Servicing 716 55202
 12 V.

Replacing SEV



130964

Replacing 725 63702
Servicing 702 29002, -29602, -29702, -30002, -30102, -30202
 12 V.

Rectifiers



130839

Replacing 712 12403
Servicing 712 06002, -10002, -10402
 Positive



133253

Replacing 702 50003, -50403
Servicing 702 20402, -25002, -25102, -29002, -29102, -29402, -29502, -29602, -29702, -29802, -30002, -30102, -30202, -30303, -30402, -30502
 "FRED" brushless alternators



133379

Replacing 725 90602
Servicing 716 51802, -51902, -52402, -52607, 717 70202
 12 V.



130840

Replacing 712 13503
Servicing 712 06002, -10002, -10402
 Negative

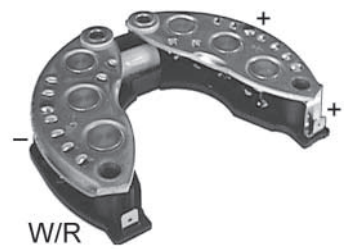

133689

Replacing 712 15303, 300082
Servicing 716 35102, -35602, -35902, -36102, -50002, -50402, -50802, -51802, -51902, -52402, -52602, 717 70102, -70202
 105 Amp.
 W/ capacitor

Adjustable voltage



138990

Same as Cargo130964 but adjustable
 12 V.

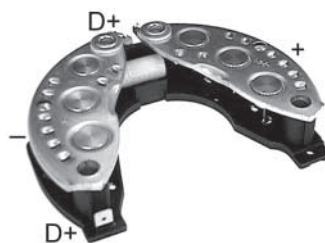

131569

Replacing 712 15103, -15403, -16903
Servicing 716 35202, -35502, -35802, -36002, -36202, -45002, -50202, -51202
 105 Amp.
 W/ diode trio, capacitor, resistor 82 Ohm (D+/-)

Replacing SEV

Diode Trios



130682 Std pkg 5 **A**
Replacing 712 09803, -13003
Servicing 712 10002, -10302, -10402, -10602, -10702, -10902, -11302, -11402

Slip Rings



130718 **A**
Replacing 719 51903
 O.D. 39 mm, Shaft 19.50 mm, L. 24.6 mm



131037 **A**
Replacing 719 51703
 O.D. 39 mm, Shaft 17 mm, L. 24 mm



133351 Std pkg 5 **A**
Servicing Rotor 711 53403, 131645
 O.D. 34 mm, Shaft 17 mm, L. 23 mm
 6 splines



137531 Std pkg 10
 40 x 37 x 7.8 mm
 Copper ring
*Quick repair for slip ring:
 Cargo 130718, 131037*

Brush Boxes

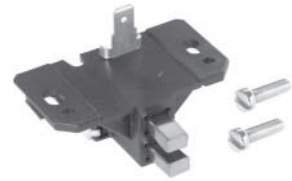

130713 **A**
Replacing 719 31093
Servicing 712 10302, -10402, -10602, -10702, -10902, -12702, -20102, -20402
 Complete w/ brushes

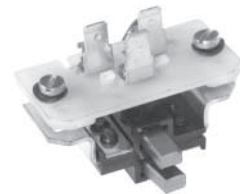

130714 **A**
Replacing 719 31403
Servicing 712 12302, -12402, -12602, 713 12002
 Complete w/ brushes

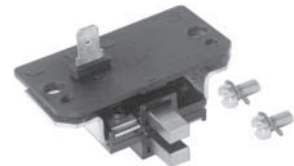

131704 **A**
Replacing 719 31003
Servicing 712 00002, -00102, -03002, 722 93202
 Complete w/ brushes



132396
Replacing 719 01903
 Complete w/ brushes and wire harness

Replacing SEV

Also see Pulley Survey
page 809

Fan & Pulleys



131203

Servicing 713 12002, 716 55002,
717 70002
O.D. 76.2 mm, Bore 17 mm, W. 37.8 mm,
Double

Brush Sets



SVX5 2 Std pkg 10 **A**

4.5 x 6.3 x 13.5 mm
12 V.



SVX7 2 Std pkg 10 **A**

Replacing 300 821
4.5 x 6.3 x 14 mm
12 V.



SVX9 2 Std pkg 10 **A**

4.6 x 6.4 x 15 mm
12 V.

Sundry Parts



132320 Std pkg 5 **A**

Replacing 717 81003
Servicing 712 30302
Terminal cover



133199 **A**

Replacing 1234926-2
Servicing Volvo
3-pin terminal



133650 Std pkg 10

Wire clip

Replacing TECUMSEH

Regulators

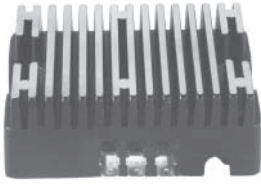

138895

Replacing 610749

14.5 V. For permanent magnet system,
20 Amp. max.

Terminals: STA- B+ -STA
Regulator/rectifier

Replacing VALEO KOREA

Rotors

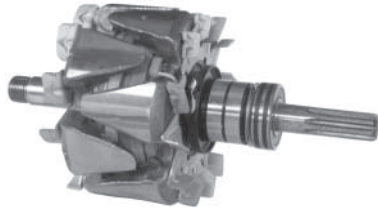

234619

Replacing TA200C08102
Servicing TA000A57301
 12 V. 110 Amp.
 L. 211 mm, O.D. 105 mm, Shaft 17 mm,
 8 splines

234652

Replacing TA200C10901
Servicing AB170094, TA001A33001
 12 V. 80 Amp.
 L. 140 mm, O.D. 99.4 mm, Shaft 17 mm

Stators



136612

Replacing TA100B10601
Servicing TA000A57401
 12 V. 75 Amp.
 O.D. 133 mm, I.D. 106 mm, W. 20 mm



234618

Replacing TA100B09701
Servicing TA000A57301
 12 V. 110 Amp.
 O.D. 133 mm, I.D. 106 mm, W. 26.5 mm



234651

Replacing TA100C07501
Servicing AB180128, TA001A33001
 12 V. 80 Amp.
 O.D. 125.5 mm, I.D. 100 mm, W. 20.4 mm



234695

Replacing TA100C03701
Servicing AC165610, -616, -617, -618
 12 V. 55 Amp.
 O.D. 120 mm, I.D. 95 mm, W. 28 mm



234824

Servicing TA000A28801 
 12 V. 70 Amp.
 O.D. 126 mm, I.D. 100 mm, W. 20.1 mm

Replacing VALEO KOREA

Brackets D.E.

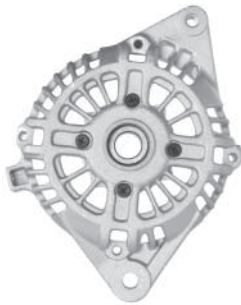

234491
Replacing TA300B15901, TA301B16001
Servicing TA000A57401
 W/ bearing



234493
Replacing TA300B16101, TA301B15901
Servicing TA000A57301
 Bearing: Cargo 140278



234495
Replacing TA300B13601
Servicing AB180128, TA001A33001
 Bearing: Cargo 140093

Brackets S.R.E.

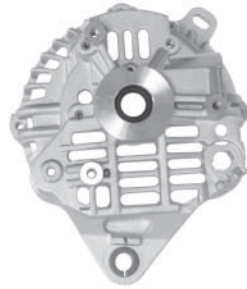

234492
Replacing TA431A15801
Servicing TA000A57401
 W/ oil seal



234494
Replacing TA431A15701
Servicing TA000A57301
 W/ oil seal



234496
Replacing TA400B18101
Servicing AB180128, TA001A33001
 Bearing: Cargo 140084

Regulators



234620
Replacing TA500C11601
Servicing TA000A57301, -57401
 12 V.



234654
Replacing TA500C09001
Servicing AB180128, TA000A33001
 12 V.

Replacing VALEO KOREA

Also see Pulley Survey
page 809

Rectifiers



⊕ _____ 90 mm _____ ⊕

234653

Replacing TA600C13301
Servicing AB180128, TA001A33001
8 diodes
W/ diodetrio
B+ terminal M8 x 25 mm

Fan & Pulleys



237674

Replacing F-232774.03, -04 **N**
Servicing AF111393, 37300-4A110
O.D. 68 mm, Bore 17 mm, W. 41 mm,
7 grooves, w/ Free wheel
Pulley tool: Cargo 210843

238200

Servicing TA000A61201 **N**
18.5 x 33 x 5.97 mm
Rotor vane set



210843

Tool to be used for mounting and
dismounting of free wheel pulleys
Shaft L. 74 mm.

210948

As Cargo 210843, but
Shaft L. 114 mm.

Replacing VALEO / PARIS RHONE

Rotors

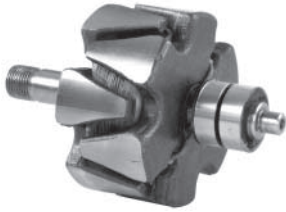

130248

Replacing 078887

Servicing A12M1, -2, -3, -4, -5, -6, -7, -8
12 V. 35 Amp.

L. 144 mm, O.D. 89 mm, Shaft 17 mm



130901

Replacing 300684

Servicing A13R248
12 V. 55 Amp.

L. 144.5 mm, O.D. 89 mm, Shaft 17 mm

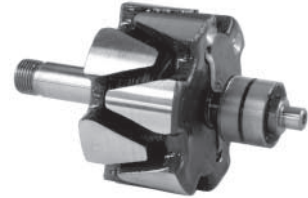

131118

Replacing 078712, 092905

Servicing A12R1, -3, -4, -6, -8, -9, -10, -11, -12, -13, -22, -25, -26, -27, -30, -31, -32, -34, -36, -38, -43, -44, -45, -46, -53
12 V. 40 Amp.

L. 142 mm, O.D. 82 mm, Shaft 17 mm



130262

Replacing 094945

Servicing A13M8, -11, -16, A13R63, -95, -96, -115, -117, -123, -124, -125, -126, -127, -129, -143, -166, -167, -177, -212, -215, -225
12 V. 36 Amp.

L. 144 mm, O.D. 89.5 mm, Shaft 17 mm



131049

Replacing 092868, 300702

Servicing A13R214
24 V. 35 Amp.

L. 141 mm, O.D. 89 mm, Shaft 17 mm



131245

Replacing 092985

Servicing A13N12, -18, -20, -64
12 V. 50 Amp.

L. 161 mm, O.D. 89 mm, Shaft 17 mm



130265

Replacing 095315

Servicing A13M2, -3, -4, -5, -6, -7, -9, -12, -14, -16, -17, A13R105, -194, -195, -224
12 V. 45 Amp.

L. 144 mm, O.D. 89 mm, Shaft 17 mm

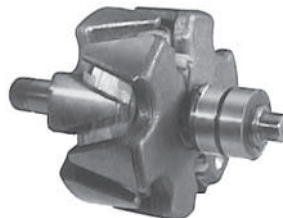

131067

Replacing 092855

Servicing A13R189, -203, -218, -221, -222, -228, -230, -260, -269, -270
12 V. 48 Amp.

L. 141 mm, O.D. 89 mm, Shaft 17 mm



131455

Replacing 300890, 690639

Servicing A13N15, -62, -90, -95, -146T, -167, -181, -182, -203, -261
12 V. 50 Amp.

L. 136 mm, O.D. 89 mm, Shaft 17 mm

Replacing VALEO / PARIS RHONE



131644

Replacing 300718
Servicing A14R3, -11, -17, -22, -27
 12 V. 80 Amp.
 L. 156 mm, O.D. 99 mm, Shaft 17 mm



131967

Replacing 092932
Servicing A14N1, -2, -13, -19, -22, -37, -50, -53, -69
 12 V. 80 Amp.
 L. 144.5 mm, O.D. 100 mm, Shaft 17 mm



131970

Replacing 300734
Servicing A13R267, -268
 12 V. 50 Amp.
 L. 156 mm, O.D. 88 mm, Shaft 17 mm



131645

Replacing 300660
Servicing A13R259, -266
 12 V. 55 Amp.
 L. 136 mm, O.D. 89 mm, Shaft 17 mm



131968

Replacing 092968, 300886
Servicing A13N6, -13, -14, -25, -26, -27, -29, -30, -38, -39, -40, -42, -43, -44, -53, -65, -69, -76, -81, -82, -83, -84, -92, -93, -94, -99
 12 V. 50 Amp.
 L. 145 mm, O.D. 89.5 mm, Shaft 17 mm



131971

Replacing 300846
Servicing A13N17, -19, -46, -49, -50, -91, -123
 12 V. 50 Amp.
 L. 149 mm, O.D. 89 mm, Shaft 17 mm



131812

Replacing 300696
Servicing A14R25, -26, -28, -35, -37, -42, -43, -45, -46
 12 V. 80 Amp.
 L. 156 mm, O.D. 99 mm, Shaft 17 mm



131969

Replacing 300853
Servicing A13N31, -32, -41, -118
 12 V. 50 Amp.
 L. 157 mm, O.D. 89 mm, Shaft 17 mm



133003

Replacing 590625
Servicing A13N158, -159, -161, -162, -164, -171, -177, -183, -184
 12 V. 70 Amp.
 L. 140 mm, O.D. 89 mm, Shaft 17 mm

Replacing VALEO / PARIS RHONE



133115

Replacing 182055
Servicing A14N104, -138
 24 V. 75 Amp.
 L. 168 mm, O.D. 99 mm, Shaft 17 mm



136258

Replacing 590578
Servicing A13N156, -176, -185, -216
 12 V. 70 Amp.
 L. 152 mm, O.D. 89 mm, Shaft 17 mm



137538

Replacing 590634, 592724
Servicing A13N172, -173, -178, -179, -180, -188, -200, -201, -202, -233
 12 V. 75 Amp.
 L. 149 mm, O.D. 90 mm, Shaft 17 mm



133587

Replacing 182174, 300774
Servicing A14N30M, -43M, -44M, -47M, -81M, -100M, -112M, -115M, -116M, -118M
 24 V. 55 Amp.
 L. 165 mm, O.D. 100 mm, Shaft 17 mm

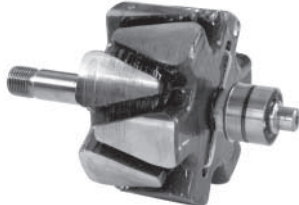

137068

Replacing 182006
Servicing A14N73, -75, -76, -95, -124, -140, -165, -180
 12 V. 110 Amp.
 L. 163 mm, O.D. 99.5 mm, Shaft 17 mm

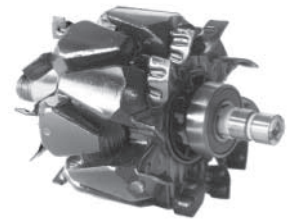

137580

Replacing 593147
Servicing A13VI 71, -73, -88, -94, -101, -118, -140, -141, -142, -151, -180, -191, -200, -201, -204, -231, -233, -242, -243
 12 V. 95/120 Amp.
 L. 152 mm, O.D. 98.5 mm, Shaft 17 mm



133969

Replacing 300738
Servicing A14N39, -133, -135
 24 V. 60 Amp.
 L. 160 mm, O.D. 99 mm, Shaft 17 mm

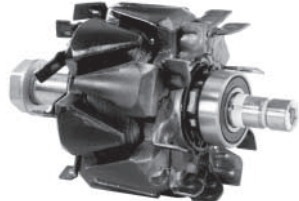

137523

Replacing 592821, 592912, -14, 593146
Servicing A11VI 11, -17, -18, -21, -22, -23, -25, -26, -28, -29, -30, -31, -32, -35, -36, -40, -43, -44, -45, -46, -48, -49, -51
 12 V. 70 Amp.
 L. 149 mm, O.D. 89 mm, Shaft 17 mm

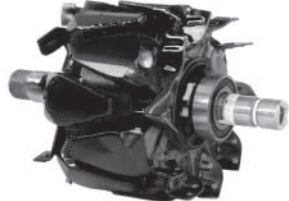

137731

Replacing 592818, 592820, 593143
Servicing A13VI 10, -11, -13, -14, -16, -18, -20, -23, -24, -25, -28, -30, -31, -34, -40, -41, -44, -45, -46, -48, -49, -51, -52
 12 V. 90 Amp.
 L. 152.5 mm, O.D. 95 mm, Shaft 17 mm

Replacing VALEO / PARIS RHONE



138116

Replacing 593145, 593149, 593153
Servicing A13VI 32, -57, -68, -80, -81, -84, -85, -86, -87, -88, -95, -96, -104, -105, -106, -107
 12 V. 80 Amp.
 L. 152 mm, O.D. 95 mm, Shaft 17 mm



139694

Replacing 300681
Servicing A14N3T, -12T, -28T, -32T, -114T
 24 V. 60 Amp.
 L. 156 mm, O.D. 99.40 mm, Shaft 17 mm

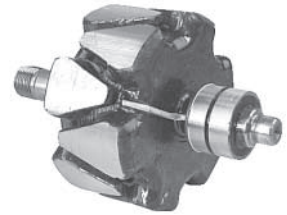

230334

Replacing 092961
Servicing A13N4T, -5T, -22T, -61T, -140T, -229T
 24 V. 40 Amp.
 L. 145 mm, O.D. 90 mm, Shaft 17 mm



138855

Replacing 593274
Servicing A14VI 10, -11, -13, -14, -18, -22, -24, -28, -30, -31
 12 V. 120 Amp.
 L. 150 mm, O.D. 110.4 mm, Shaft 17 mm

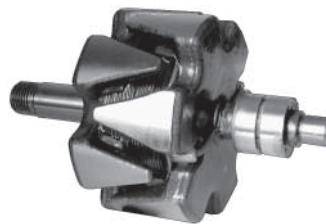

230255

Replacing 592808, 592809
Servicing A13V02, -05, -07
 12 V. 70 Amp.
 L. 148.5 mm, O.D. 90 mm, Shaft 17 mm

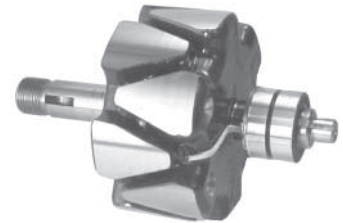

230486

Replacing 092979
Servicing A13N10, -86, -87, -88, -89, -106, -112, -116, -120, -124, -136, -160, -163, -187, -214
 12 V. 70 Amp.
 L. 145.2 mm, O.D. 90 mm, Shaft 17 mm



139447

Replacing 593285
Servicing A14VI 15, -16, -17, -25, -27, -29, -35
 12 V. 150 Amp.
 L. 150 mm, O.D. 110 mm, Shaft 17 mm

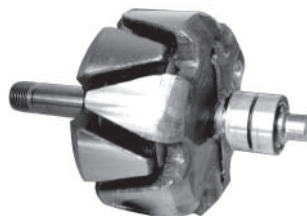

230256

Replacing 593264
Servicing A14N182, -185, -190
 24 V. 55 Amp.
 L. 159.5 mm, O.D. 99 mm, Shaft 17 mm



231207

Replacing 092893, 300720
Servicing A13R220, -231, -243, -247, -256, -263
 12 V. 50 Amp.
 L. 159 mm, O.D. 89.5 mm, Shaft 17 mm

Replacing VALEO / PARIS RHONE

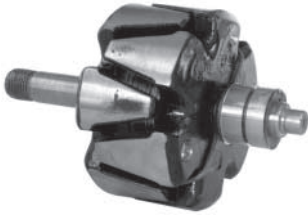

231293

Replacing 300694
Servicing A14N4, -23, -36, -44, -71, -78, -80, -144, -163, -176, -199
 12 V. 80 Amp.
 L. 167.5 mm, O.D. 99.4 mm, Shaft 17 mm



231296

Replacing 592782
Servicing A14V01, -02, -03, -04, -07, -09, -10, -12, -13
 12 V. 105 Amp.
 L. 172 mm, O.D. 98 mm, Shaft 17 mm

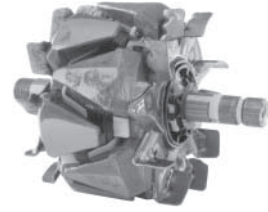

232766

Servicing SG12B012
 12 V. 120 Amp.
 L. 148.4 mm, O.D. 105.2 mm, Shaft 17 mm

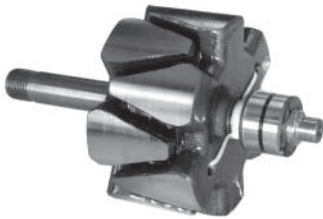

231294

Replacing 300737
Servicing A14N51, -56, -77, -103, -121, -130
 12 V. 90 Amp.
 L. 172 mm, O.D. 99.4 mm, Shaft 17 mm

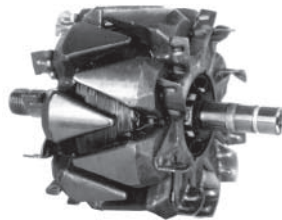

231873

Replacing 593432
Servicing 2542233, -493, HD90S013, -015
 24 V. 90 Amp.
 L. 155.5 mm, O.D. 110.3 mm, Shaft 17 mm

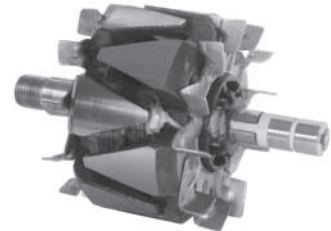

234130

Replacing 593571
Servicing SG7S014, -015, -016
 12 V. 90 Amp.
 L. 144.5 mm, O.D. 91 mm, Shaft 17 mm

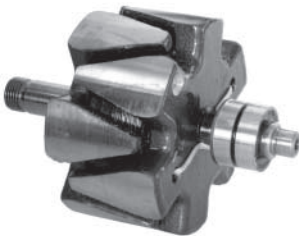

231295

Replacing 300807
Servicing A14N18, -54, -63, -65, -106, -107, -113, -117, -131, -151, -156, -158
 12 V. 90 Amp.
 L. 147.5 mm, O.D. 99.4 mm, Shaft 17 mm



231883

Replacing 092964
Servicing A13N1M, -147M, -148M, -149M, -186M, -2M, -259, -259M, -35M
 12 V. 40 Amp.
 L. 156 mm, O.D. 89.5 mm, Shaft 17 mm

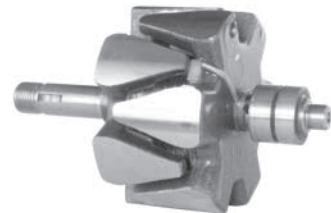

234603

Replacing 300904
Servicing A14N67
 12 V. 90 Amp.
 L. 167.5 mm, O.D. 99.4 mm, Shaft 17 mm

Replacing VALEO / PARIS RHONE



234623

Replacing SG12B020, -045
24 V. 80 Amp.
 L. 148 mm, O.D. 105.4 mm, Shaft 17 mm



234981

Replacing 593574
Replacing A13Vi203, -276, -278,
 SG8B017, -020, -021, SG9B063, -066
12 V. 80 Amp.
 L. 143 mm, O.D. 95.3 mm, Shaft 17 mm



235366

Replacing 593569
Replacing SG14B010, -11, -12, -13, -16
12 V. 140 Amp.
 L. 148 mm, O.D. 105 mm, Shaft 17 mm



Rotor Parts



234709

Replacing A11Vi91, -99, -106, -175, -197,
 -204, -220, -242, -276, -277, SG7S010,
 SG8B020, -021, SG9B063, SG10B021,
 -022
O.D. 33/24.7 mm, I.D. 17.2 mm, W. 8.25 mm
 Spacer



235153

Replacing A12R34, -45, A13N147, -144,
 -163, -104, 147M, -10, -51, -56, -148M,
 -129, -175, -215, -149M, -49, -267, -110, -1M
O.D. 27.86 mm, I.D. 17/21.70 mm,
Th. 6.12 mm
 Spacer



234710

Replacing A13N1M, -2M, -4T, -5T, -22T,
 -35M, -38, -43, -56M, -147M, -148M,
 -149M, -229T, -259, -259M, -275, -283,
 -283M, -293, A13R267, A14N62, -114
6.75 x 15.3 x 1.45 mm
 Washer



Stators



130253

Replacing 093003
Replacing A13R166, -212, -215, -224
12 V. 50 Amp.
O.D. 126.2 mm, I.D. 89.8 mm, W. 25.8 mm



130962

Replacing 078711, 094519
Replacing A12R38
12 V. 40 Amp.
O.D. 118 mm, I.D. 82.3 mm, W. 20 mm



131052

Replacing 102589, 101518
Replacing A14N39, A14R33, A14N3T,
 -28T, -30M, -32T, -110M, -112M, -114T,
 -115M, -116M, -119M, -137, -141M, -183
24 V. 55 Amp.
O.D. 135.9 mm, I.D. 99.2 mm, W. 29.1 mm

Replacing VALEO / PARIS RHONE



131456

Replacing 100930
Servicing A13N12, -13, -14, -15, -17, -18, -19, -20, -26, -27
 12 V. 50 Amp.
 O.D. 126.9 mm, I.D. 89.4 mm, W. 26.6 mm



132375

Replacing 102604, 101899
Servicing A13N11, -3M, -6M, -45T, -143M
 24 V. 35 Amp.
 O.D. 126.9 mm, I.D. 89.4 mm, W. 26 mm



132378

Replacing 102778
Servicing A13N85, -86, -87, -88, -89, -97, -106, -107, -110, -113, -116, -117, -120, -121, -124, -136
 12 V. 65 Amp.
 O.D. 126.8 mm, I.D. 89.3 mm, W. 25.8 mm



131649

Replacing 098887D
Servicing A12M9, -11, -15, -16, -17
 12 V. 32 Amp.
 O.D. 118.2 mm, I.D. 89.7 mm, W. 22.6 mm



132376

Replacing 099156
Servicing A13R192, -203, -218, -220, -221, -222, -228, -230, -231, -242, -243, -244, -245, -247, -256, -260, -262, -263
 12 V. 55 Amp.
 O.D. 126.8 mm, I.D. 89.3 mm, W. 24 mm



133002

Replacing 592826
Servicing A13V2, -5, -7
 12 V. 75 Amp.
 O.D. 126.9 mm, I.D. 89.2 mm, W. 29.3 mm



131982

Replacing 100273, 101025, 101868
Servicing A14N1, -2, -4, -9, -10, -12, -13, -14, -16, -18, -19, -22, -23, -29M, -31T, -35, -36, -37, -38, -50, -51, -53, -54, -55
 12 V. 80 Amp.
 O.D. 135.8 mm, I.D. 99.5 mm, W. 27.9 mm



132377

Replacing 098041
Servicing A14R3, -11, -17, -22, -27, -43
 12 V. 80 Amp.
 O.D. 136 mm, I.D. 99.4 mm, W. 28.5 mm



133144

Replacing 518689
Servicing A14N104, -138
 24 V. 75 Amp.
 O.D. 142.5 mm, I.D. 99.3 mm, W. 25.3 mm

Replacing VALEO / PARIS RHONE



135533

Replacing 592832
Servicing A13VI 11, -13, -17, -18, -21, -22, -25, -28, -30, -32, -34, -35, -40, -41, -44, -45, -47, -52, -55, -57, -62, -63, -67
 12 V. 90/100 Amp.
 O.D. 127 mm, I.D. 95.9 mm, W. 30.7 mm



135788

Replacing 592834, 593279
Servicing A11VI 11, -17, -18, -21, -22, -23, -25, -28, -31, -62, -64, -66, -67, -76, -77, -79, -81, -82, -85, -86, -87, -88, -92
 12 V. 60/70 Amp.
 O.D. 116.1 mm, I.D. 89.3 mm, W. 29.4 mm



137581

Replacing 593158
Servicing A13VI 71, -94, -101, -142
 12 V. 95 Amp.
 O.D. 127.8 mm, I.D. 98.1 mm, W. 29.7 mm



135665

Replacing 101339
Servicing A13N4T, -5T, -22T, -33M, -35M, -51, -55M, -56M, -57M, -59M, -61T, -140T, -190, -229T
 24 V. 40 Amp.
 O.D. 127.1 mm, I.D. 89.4 mm, W. 25.3 mm



135966

Replacing 2518688
Servicing A14N73, -75, -76, -95, -124, -140, -180
 12 V. 105 Amp.
 O.D. 142.4 mm, I.D. 98.9 mm, W. 25.6 mm



138302

Replacing 593161
Servicing A13VI118, -140
 12 V. 130 Amp.
 O.D. 127.7 mm, I.D. 98.5 mm, W. 29.3 mm



135787

Replacing 592833
Servicing A11VI 10, -16, -24
 12 V. 50 Amp.
 O.D. 115.9 mm, I.D. 89.2 mm, W. 27.2 mm



136226

Replacing 592699, 592823
Servicing A14V01, -02, -03, -04, -05, -13
 12 V. 105 Amp.
 O.D. 142.2 mm, I.D. 104 mm, W. 28.4 mm



138503

Replacing 592828
Servicing A13N198, -258, -273
 12 V. 80 Amp.
 O.D. 127.2 mm, I.D. 89.5 mm, W. 30.3 mm

Replacing VALEO / PARIS RHONE



139448
Replacing 593159
Servicing A14VI 10, -11, -13, -14
 12 V. 120 Amp.
 O.D. 142 mm, I.D. 111 mm, W. 30 mm



231348
Replacing 105550
Servicing A14N67
 12 V. 90 Amp.
 O.D. 142.2 mm, I.D. 99.1 mm, W. 25.2 mm



233794
Replacing 592957
Servicing A14V08, -14, -17
 12 V. 90 Amp.
 O.D. 142.5 mm, I.D. 104.7 mm, W. 28.9 mm



139449
Replacing 593286
Servicing A14VI 15, -16, -17, -25, -27, -29, -35
 12 V. 150 Amp.
 O.D. 142.3 mm, I.D. 110.5 mm, W. 30.3 mm



233699
Replacing 106027, 518630, 592830
 12 V. 70 Amp.
 O.D. 126.5 mm, I.D. 82.3 mm, W. 51.3 mm



233957
Replacing 593358
Servicing A13Vi203, -236, -276
 12 V. 80 Amp.
 O.D. 127.5 mm, I.D. 96 mm, W. 24.2 mm



230272
Replacing 592831
Servicing A13VI 109, -119, -132, -149, -152, -165, -166, -184, -189, -211, -212, -217, -224, -230, -232, -235, -252, -256
 12 V. 80 Amp.
 O.D. 127 mm, I.D. 95.6 mm, W. 30.7 mm



233713
Servicing SG12B012, -049
 12 V. 120 Amp.
 O.D. 138 mm, I.D. 106 mm, W. 30 mm



233962
Replacing 101273, NC130
Servicing A13R85, -85T, -87, -88, -88T, -89, -89T, -98, -160, -163, -163T, -179, -179T, -188T, -191T, -205
 24 V. 30 Amp.
 O.D. 127 mm, I.D. 90 mm, W. 26 mm

Replacing VALEO / PARIS RHONE



234345

Replacing 593583
Servicing SG10B010, -011, -016, -019, -020, -031, -032, -035
 12 V. 120 Amp.
 O.D. 128 mm, I.D. 99 mm, W. 29.5 mm



234674

Replacing 593281 
Servicing A14Vi19, -20 HD90S, HD90S011, -15
 24 V. 90 Amp.
 O.D. 142.5 mm, I.D. 111 mm, W. 30 mm



235224

Replacing 593590 
Servicing SG7S010, -012, -013, -014, -015, -016, -021, -024, -025, TG7S010
 12 V. 75 Amp.
 O.D. 119 mm, I.D. 92.5 mm, W. 30 mm



234618

Replacing TA100B09701
Servicing TA000A57301
 12 V. 110 Amp.
 O.D. 133 mm, I.D. 106 mm, W. 26.5 mm



234978

Replacing 593586 
Servicing SG10B021, -022, -023
 12 V. 90 Amp.
 O.D. 127 mm, I.D. 98.5 mm, W. 29.5 mm



235264

Replacing 101520 
Servicing A14N37, A14N111
 12 V. 80 Amp.
 O.D. 135.75 mm, I.D. 99.45 mm, W. 57.65 mm



234666

Servicing SG12B020, -45 
 24 V. 80 Amp.
 O.D. 136 mm, I.D. 106 mm, W. 30 mm



235089

Replacing 593588 
Servicing SG15S016, -018, -019, -021, -022, -024, -031
 12 V. 150 Amp.
 O.D. 142.5 mm, I.D. 111 mm, W. 30.4 mm



235283

Replacing 593585 
Servicing SG8B010, -011, -013, -015, -018, SG9B015, -018, -024, -055, -078
 12 V. 70 Amp.
 O.D. 127.5 mm, I.D. 96 mm, W. 24.3 mm

Replacing VALEO / PARIS RHONE

Stator Parts

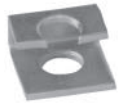

233987 Std pkg 10
Servicing A11Vi44, -45, -56, -59, -61, -76, -77, -79, -86, A13Vi52, -54, -73, -81, -82, -94, -99, -104, -114, -132, -137, -142, -149, -273
 Clamp for stator

Brackets D.E.



136851
Replacing 100269
Servicing A14N1, -2
Bearing: Cargo 140093



138589
Replacing 097489
Servicing A13N7, -29, -30, -65, -81, -86, -87, -88, -89
Bearing: Cargo 140087



138034
Servicing A13E45, 2940311
Bearing: Cargo 140087



138590
Replalcing 097626
Servicing A13N6, -38, -43, -94
Bearing: Cargo 140087



138588
Servicing A13N167, -182, -219
Bearing: Cargo 140087



230213
Replacing 105864
Servicing A14N73, -75, A14N104, -138, -140, -160, -205, 2541178, 2541197, 2541329, 2541849, 5002781
Bearing: Cargo 140093

Replacing VALEO / PARIS RHONE



230947

Servicing A11Vi10, -37, -42, 2541299, 2541677, 2541718
Bearing: Cargo 140093



231836

Servicing A13Vi47, -107
Bearing: Cargo 140093



231942

Servicing A11Vi45
Bearing: Cargo 140093



231539

Replacing 104297
Servicing A14N47M, -81M, -100, -112M, -118M, -119M, -141M
Bearing: Cargo 140401



231943

Servicing A13Vi46
Bearing: Cargo 140093



231542

Servicing A11Vi163, -195, A13Vi62, -66
Bearing: Cargo 140093



231935

Servicing A11Vi43, -44, -55, -56
Bearing: Cargo 140093



232205

Servicing A14N144, A14N4
Bearing: Cargo 140093

Replacing VALEO / PARIS RHONE



232207
Servicing A13N2M
Bearing: Cargo 140093

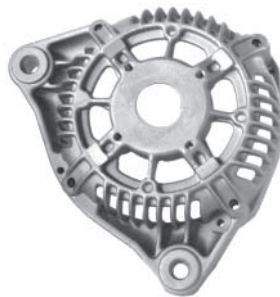

232446
Servicing A13Vi190
Bearing: Cargo 140093



233322
Servicing A13Vi260, -261, -262
Bearing: Cargo 140093



232425
Servicing A13Vi31
Bearing: Cargo 140093



233127
Servicing A14Vi19, -20
Bearing: Cargo 140263

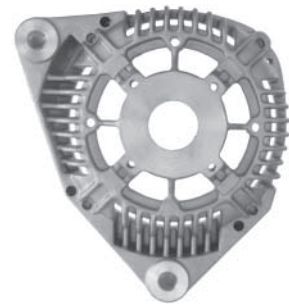

233463
Servicing A13Vi74, -99, -100, -134, -135, -170, -176, -198, 2541680, -775, -776, -839, -911, -920
Bearing: Cargo 140263



232426
Servicing A11Vi66
Bearing: Cargo 140093

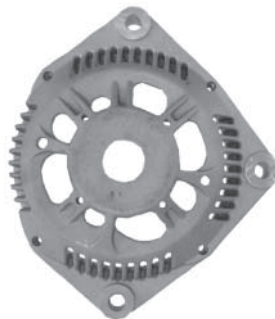

233131
Servicing HD90S013, HD90S014
Bearing: Cargo 140957

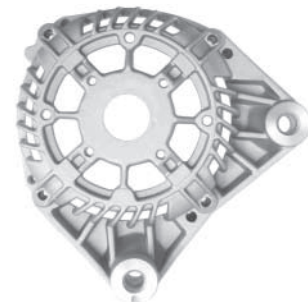

233464
Servicing A13Vi54, -132, -160, 2541494, -835, -912
Bearing: Cargo 140093

Replacing VALEO / PARIS RHONE



233781

Servicing A13N125, -180, -274, -276
Bearing: Cargo 140087



233806

Servicing A14VI27, -35
Bearing: Cargo 140263



233958

Replacing 100675
Servicing A13N4T, -5T, -22T, -56M, -140, -140T, -229T, -283, -283M
Bearing: Cargo 140093



233800

Servicing A13VI11, -13, -14, -20, -28, -30, -35, -52, -57
Bearing: Cargo 140093



233807

Replacing 593652
Servicing SG12B020, -40, -45
Bearing: Cargo 140263



233963

Servicing A13VI84, -142, -273
Bearing: Cargo 140093



233803

Servicing A11VI15, -16, -23, -32, -40, -47, -48, -49, -57
Bearing: Cargo 140093

233909

Servicing A13VI39, -41, -44, -114, -121, -124, -126, -137
Bearing: Cargo 140093



234179

Servicing A13VI141, -146, -183, -246, -256, -279, -288
Bearing: Cargo 140093

Replacing VALEO / PARIS RHONE

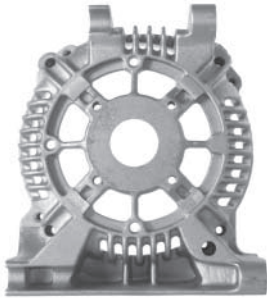

234180

Servicing A13VI178, -202, -237
Bearing: Cargo 140093

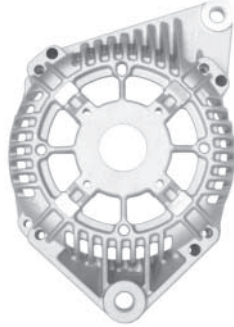

234279

Servicing A13VI52
Bearing: Cargo 140093

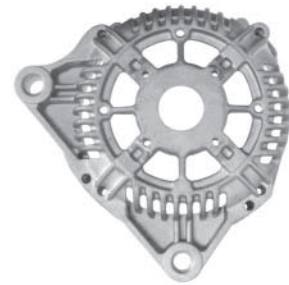

234606

Servicing A13Vi204, -242
Bearing: Cargo 140093



234183

Servicing A14VI22, -28, -29
Bearing: Cargo 140263



234280

Servicing A13VI18, -76, -97, -150
Bearing: Cargo 140093



234894

Replacing 593632
Servicing SG12B017, -30, -38, -50, -52, -55, -71, -72, -81
Bearing: Cargo 140093

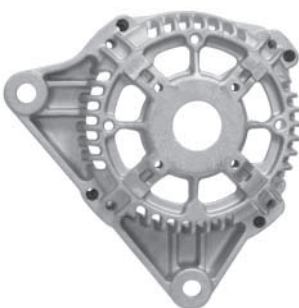

234224

Servicing A11VI91, -99, -106
Bearing: Cargo 140093

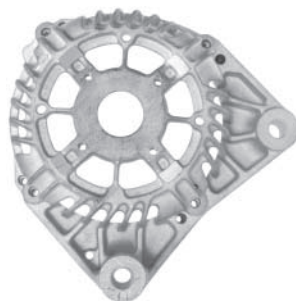

234433

Servicing A13VI119, -140, -160, -234
Bearing: Cargo 140093

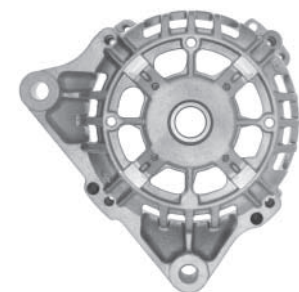

234979

Replacing 593651
Servicing SG10B021, -022, -023
 W/ bearing



Replacing VALEO / PARIS RHONE



234980

Replacing 593650
Servicing SG8B020, -021, -022,
 SG9B063, -064, -066, -067
 W/ bearing



235011

Servicing A13Vi203, -236, -276
 Bearing: Cargo 140093



235132

Servicing A14VI 10, -11, -30, -31, -37
 Bearing: Cargo 140263



234990

Servicing A11Vi81, -88, -92, -97
 Bearing: Cargo 140093



235015

Servicing SG7S010, -14, -15, -16, -24
 Bearing: Cargo 140093



235181

Replacing 593627
Servicing SG12B010, -011, -018, -025,
 -054, SG14B012, -013
 Bearing: Cargo 140093



234995

Replacing 593635
Servicing SG75010, -013
 W/ bearing

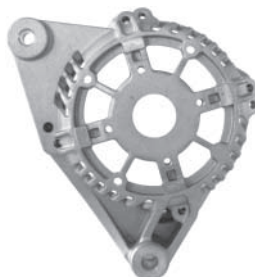

235031

Servicing A11Vi89, -102, -108
 Bearing: Cargo 140093

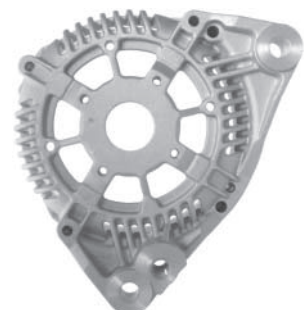

235342

Servicing A13VI78
 Bearing: Cargo 140093



Replacing VALEO / PARIS RHONE

Brackets S.R.E.

236544

Replacing 593827
 Servicing TG11C014, -015, -016
 Bearing: Cargo 140093
 Bearing plate: Cargo 231557



138587

Servicing A13V02, -06
 Bearing: Cargo 140081



230989

Replacing 2590024
 Servicing A14N30M, -43M, -81, -100, -112M, -115M, -116M, -118M, -119M, 137M, -177M, -196M
 Bearing: Cargo 140081



139035

Servicing 2940305, 2940375, A13E07, A13E13
 Bearing: Cargo 140079

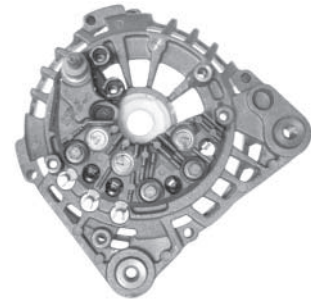

231098

Replacing 593415
 Servicing SG12B015, -042
 120 Amp.
 B+ terminal M8 x 14.2 mm
 W/ rectifier
 Bearing: Cargo 140084



230219

Replacing 2590013
 Servicing A13N1M, -2M, -28M, -33M, -35M, -36M, -55M, -56M, -57M, -58M, -59M, -143M, -147M, -148M, -149M, -283
 Bearing: Cargo 140081

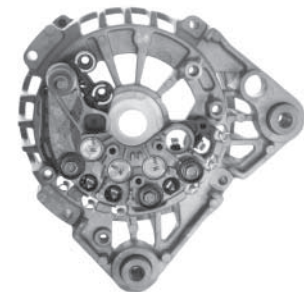

231099

Replacing 593414
 Servicing SG8B011, -013, SG9B013, -015, -049
 70/90 Amp. B+ terminal M8 x 14 mm
 W/ rectifier
 Bearing: Cargo 140084
 Bracket only: Cargo 235360

Replacing VALEO / PARIS RHONE

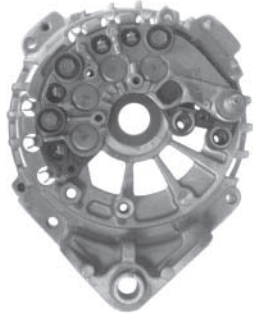

231101

Replacing 593397
Servicing SG10B010, -019
 120 Amp.
 B+ terminal M8 x 14 mm
 W/ rectifier
Bearing: Cargo 140084



231540

Servicing A11Vi21, -22
Bearing: Cargo 140084



231832

Servicing A11Vi47
Bearing: Cargo 140084



231433

Servicing A11Vi30, 2541604
Bushing: Cargo 137497
Bearing: Cargo 140084



231541

Servicing A11Vi25, -51
Bearing: Cargo 140084



231835

Servicing A13Vi70
Bearing: Cargo 140441



231434

Servicing A13Vi62, -64, -66, -153, -167
Bearing: Cargo 140084



231544

Servicing A13Vi107
Bearing: Cargo 140084



231842

Servicing A13Vi132
Bearing cap: Cargo 135171
Bearing: Cargo 140441

Replacing VALEO / PARIS RHONE



231903
 Servicing A13Vi54
 Bearing: Cargo 140441



232422
 Servicing A13Vi44, -125
 Bearing: Cargo 140441



233399
 Servicing A14Vi119, -20
 Bearing: Cargo 140084



231937
 Servicing A13Vi76
 Bearing: Cargo 140084



232447
 Servicing A13Vi102
 Bearing: Cargo 140084

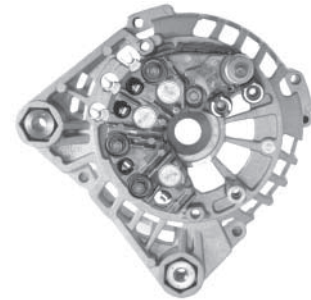

233615 
 Replacing 593385
 Servicing SG12B017, -030, -038, -050,
 -052, -055, -072, -082
 B+ terminal M8 x 14 mm
 W/ rectifier



232206
 Servicing A13Vi84
 Bearing: Cargo 140084



233319
 Servicing A13Vi18, 2541321
 Bearing: Cargo 140441

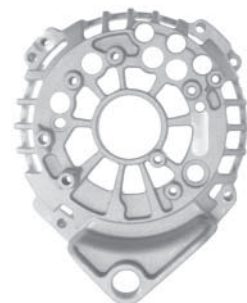

233752
 Servicing SG12B020, -045
 Bearing: Cargo 140084

Replacing VALEO / PARIS RHONE



233799

Servicing A13Vi11, -13, -14, -20, -28, -30, -35, -52, -57
Bearing: Cargo 140441

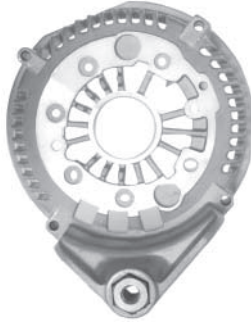

234177

Servicing A14Vi22, -28
Bearing: Cargo 140084
Bearing cap: Cargo 135508

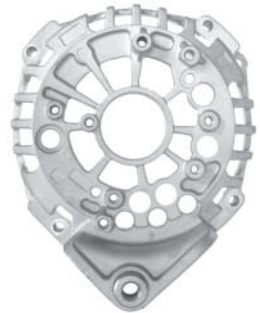

234563

Servicing SG12B040
Bearing: Cargo 140084

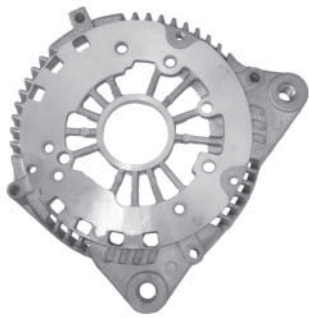

233805

Servicing A14Vi27, -35
Bearing: Cargo 140084

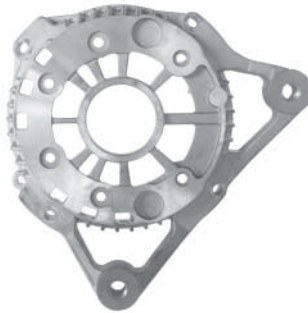

234222

Servicing A11Vi91, -99, -106
Bearing: Cargo 140084

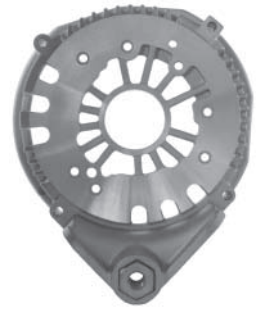

234564

Servicing A14Vi29, -34, -46
Bearing: Cargo 140084



233908

Servicing A14Vi13, -14
Bearing: Cargo 140084

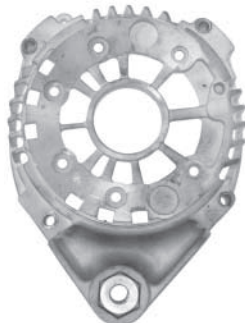

234432

Servicing A13Vi160, -234
Bearing: Cargo 140084

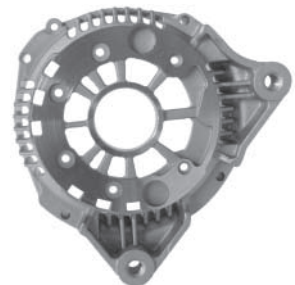

234607

Servicing A13Vi204, -242
Bearing: Cargo 140084



Replacing VALEO / PARIS RHONE

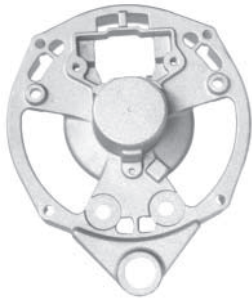

234634

Servicing A14N140, -205
Bearing: Cargo 140081

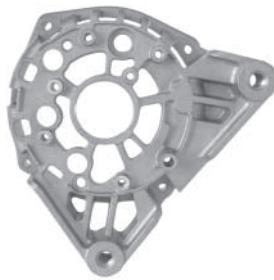

235013

Servicing SG7S014, -015, -024
Bearing: Cargo 140272



235112

Servicing SG12B017, -038, -050, -052, -071, -081, -095
Bearing: Cargo 140084



234703

Servicing A14Vi10, -11, -30, -31
Bearing: Cargo 140084



235030

Servicing A14Vi102, -108
Bearing: Cargo 140084



235126

Replacing 2590042
Servicing A14N73, -75, -160
Bearing: Cargo 140081



235012

Servicing SG10B021, -022, -023
Bearing: Cargo 140084



235075

Replacing 593447
Servicing SG12B040
120 Amp.
8 diodes
W/ rectifiers
Bearing: Cargo 140084



235129

Servicing SG12B012, -15, -42, -49, SG14B011
Bearing: Cargo 140084



Replacing VALEO / PARIS RHONE

Bracket Parts

235131

Servicing SG12B 010, -011, -018, -025, -054, SG14B012, -013
Bearing: Cargo 140084



132330

Replacing 095192
Servicing A13R150
Mounting bracket

139583

Replacing 101719
Servicing A13R268
Mounting bracket



132809

Replacing 101113
Servicing A14N63, -89, -99, -113, -117
Mounting bracket

230906

Replacing 2590574
Servicing A14N3M, -29M, -30M, -43M, -44M, -105M, -110M, -115M, -116M, -137M, -177M
Mounting bracket



235189

Servicing A11VI10, -11



132810

Replacing 101113
Servicing A13N...
Mounting bracket

231824

Replacing 590649
Servicing A14N90, -91
Mounting bracket



235343

Servicing A13VI78



134618

Replacing 102035
Servicing A14R45
Mounting bracket

235070

Replacing 593228
Servicing A14N73, -75, -160
Mounting Bracket



Replacing VALEO / PARIS RHONE



131606 A
Servicing A14R3, -17, -27,
 A14N1, -2, -55, -90, -91
 M10 x 16.6/25 x 12 mm
 Mounting bushing kit



137757
Servicing A11VI...
 M10 - 10.5 x 18.3/22 x 14.9 mm
 Mounting bushing kit, D.E.



137497
Servicing A11VI 79, -159, A13N161,
 -199, -230
 10 x 16/24 x 21 mm
 Mounting bushing, split type



131607
Servicing A12R1, -3, -4, -5, -11, A13N13,
 -29, -49, -65, -81, A13R63, -120, -141,
 -154, -177, -180, -189, -213, -228,
 -231
 10 x 14.5 x 9 mm
 Mounting bushing kit



134676 Std pkg 10
 10.1 x 16.6/24.7 x 16 mm
 Mounting bushing, steel



139705 Std pkg 10
 8.2 x 16.6/24.7 x 16 mm
 Mounting bushing



132573
Servicing A13N 147, -147M, -148, -149,
 -35M, -186, -88, A14N 100, -100M, -112,
 -118, -119, -47, -49, -137, -141, -200, -206
 8 x 10.8/23 x 23 mm
 Mounting bushing kit



134792 Std pkg 10
 10.5 x 18/22 x 16 mm
 Mounting bushing, steel



233658 Std pkg 10
Servicing A13VI119, -123, -132, -140,
 -160, -178, -190, -193, -200,
 A14VI19, -20, -28, -122, -129
 M10-1.5 x 18.7 x 23.5 mm
 Mounting bushing, S.R.E.



137756
Servicing A13VI...
 M10 - 10.4 x 18.5/22 x 12.2 mm
 Mounting bushing kit, S.R.E.



136932
Servicing A13N95
 10.5 x 18/22 x 13 mm,
 Mounting bushing, S.R.E.
 O-ring: Cargo 134776
 Nut: Cargo 191898



234713
Servicing A13Vi71, A14Vi10, -11, -30, -31,
 SD12B040
 10 x 18.6 x 26 mm
 Mounting bushing



Replacing VALEO / PARIS RHONE



234835

Replacing SG15L020, -027, SG18B017, -030, -038, -050, -055, -071, -072, TG11C010, -022
8 x 18.5 x 21 mm
Mounting bushing, S.R.E.



131827 Std pkg 5 **A**

Replacing 104809
Servicing 6200, A13N . .
O.D. 31.7 mm, I.D. 30 mm, L. 13.4 mm
Bearing cap, S.R.E.



135171 Std pkg 10 **A**

Servicing A13VI . . .
O.D. 34.3 mm, I.D. 32 mm, L. 16.2 mm
Bearing cap



230858 Std pkg 5

8 x 10 x 25.4 mm
Mounting bushing, D.E.
Tension pin



131828 Std pkg 5 **A**

Replacing 077973
Servicing 6201, A13R . .
O.D. 35 mm, I.D. 32 mm, L. 15 mm
Bearing cap, S.R.E.



135508 Std pkg 10 **A**

Servicing 6202, A13VI . . .
O.D. 37.3 mm, I.D. 35 mm, L. 19.5 mm
Bearing cap



130903 Std pkg 5 **A**

Replacing 079058
Servicing 6200, A12M1, A12R11
O.D. 33 mm, I.D. 30 mm, L. 13.3 mm
Bearing cap S.R.E.



133648 Std pkg 5 **A**

Servicing 6200, 294
O.D. 32.5 mm, I.D. 30 mm, L. 11.5 mm
Bearing cap



234146

Servicing A11VI91, SG7S015, -016
O.D. 33.8 mm,
Bearing cap



131826 Std pkg 5 **A**

Replacing 105299, 590629
Servicing 6201, A14N . .
O.D. 34 mm, I.D. 32 mm, L. 14 mm
Bearing cap, S.R.E.



135170 Std pkg 10 **A**

Servicing 6201, A11, 13VI
O.D. 32.8 mm, I.D. 32 mm, L. 16.2 mm
Bearing cap

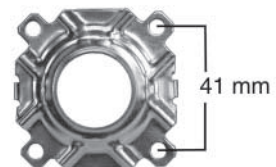

139124 Std pkg 10

Servicing A13VI ...
Bearing retainer plate
Used w/ bearing: Cargo 140093

Replacing VALEO / PARIS RHONE

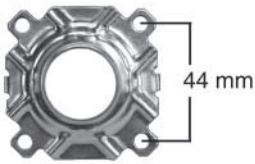

139125 Std pkg 10
Servicing A13VI ...
 Bearing retainer plate
 Used w/ bearing: Cargo 140263

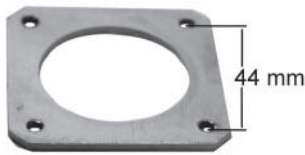

233440
Servicing A14VI...
 O.D. 57 x 57 mm
 I.D. 40.2 mm
 Bearing plate

235234
Servicing A13N23, -236, A14N47, -81M,
 -100, -100M, -112M, -116M, -118M, -119M,
 -137M, -141M, -183M, -200M, -206M
 Bearing plate

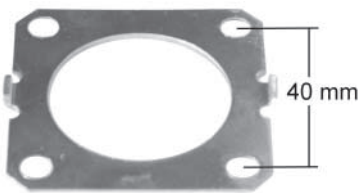

231557
Servicing A13Vi236
 O.D. 52 x 52 mm
 I.D. 37 mm
 Bearing plate

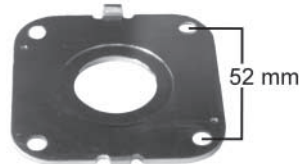

233822
Servicing HD90S...
 O.D. 67 x 67 mm
 I.D. 26 mm
 Bearing plate

231867 Std pkg 10
 M5 x 43 mm
 KNURL O.D. 5.5 mm
 Screw for S.R.E. bracket

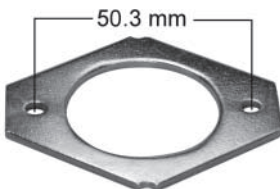

231864
Servicing A13N181
 I.D. 35.5 mm
 Bearing plate

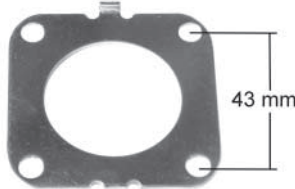

234573
Servicing A14VI48, SG12B020, -040,
 -045, SG15L026, SG15S019, -024
 O.D. 57 x 57 mm
 I.D. 37 mm
 Bearing plate

231868 Std pkg 10
 M5 x 40 mm
 KNURL O.D. 5.5 mm
 Screw for S.R.E. bracket

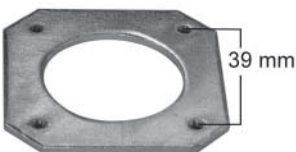

231865
Servicing A13R27, -230, -242, -270
 I.D. 34 mm
 Bearing plate

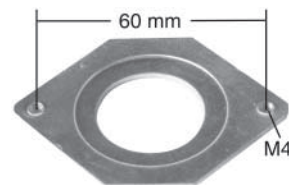

234574
Servicing A13N1M, -2M, -35M, -147M,
 -148M, -149M, -186M, -259M, A14N104,
 -138, -139, -172, -205
 O.D. 72 x 53 mm
 Bearing plate

231869 Std pkg 10
 M5 x 36 mm
 KNURL O.D. 5.5 mm
 Screw for S.R.E. bracket



Replacing VALEO / PARIS RHONE

Covers



131585

Replacing 100845
Servicing A13N..



131624

Replacing 100155
Servicing A13R248, -258, -259, -266, -267, -268, A14N1, -2, A14R33



132902

Servicing A14N117



131621

Replacing 095849
Servicing A13R..



131625

Replacing 100240
Servicing A12R38, -45



132925

Replacing 590566
Servicing A14N73, -75



131623

Replacing 098979
Servicing A13R203, -214, -218, -220, -221, -222, -228, -230, -231, -242, -243, -244, -245, -255, -256, -260, -262, -263, -269, -270, A14R45



131626

Replacing 100995
Servicing A14N4, -9, -10, -13, -14, -19, -22, -23, -35, -36, -37, -39, -40, -42, -50, -51, -53, -54, -55, -56, -59, -63, -65



133491

Replacing 590565
Servicing A13N50, -65, -112, -114, -120, -125, -127, -128, -150, -156, -157, -158, -159, -160, -161, -162, -164, -171, -172, -173

Replacing VALEO / PARIS RHONE



134975

Replacing 592942, 2519621
 Servicing A11Vi11, -23, -24, -25,
 A13Vi46, -49



135208

Replacing 095639
 Cover for Cargo 132395



135430

Replacing 592943
 Servicing A11Vi21, -22



134976

Replacing 592946, 2519836
 Servicing A11Vi15, -16, -17, -18



135243

Replacing 592945
 Servicing A13Vi13, -28, -30, -52



135436

Replacing 592944
 Servicing A13Vi11, -14, -16, -17, -20,
 -21, -23, -25, -32, -34, -35, -45, -47



135207 Std pkg 5

Servicing A13V02, -05, -07
 Mercedes



135428

Replacing 592939
 Servicing A13Vi24



136119

Replacing 590716
 Servicing A13E19, 2518017

Replacing VALEO / PARIS RHONE



136584

Replacing 180733
 Servicing A14N76, -96, -125



136662

Replacing 592941
 Servicing A13Vi18



137762

Replacing 591105, 593291
 Servicing A11Vi67, -79, -85, A13Vi157, -163, -164, -165, -166, -167, -184, -185



136585

Replacing 590695
 Servicing A14V13, 2521682



136769

Replacing 590623
 Servicing 2541139, -154, -300, 2940077, -130, -357, -361, -377, -384



137945

Replacing 593238
 Servicing A13Vi72, -73



136622

Replacing 592947
 Servicing A13Vi54

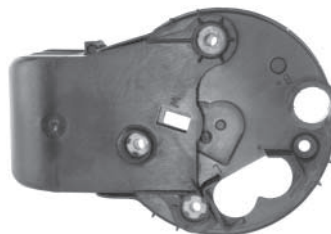

137761

Servicing A13Vi62, -66



137946

Replacing 593235
 Servicing A13Vi74, -75, -99, -100, -134, -170, -175, -176, -197, -198, -220, -222

Replacing VALEO / PARIS RHONE



138051

Replacing 591015, 593247
 Servicing A14Vi10, -13, -14, -30, -31



138501

Replacing 593252
 Servicing A13Vi61



139445

Replacing 593250
 Servicing A14Vi19, -20



138300

Replacing 592940
 Servicing A13Vi10, -63, -67, -69, -77, -126, -137, -138



138502

Replacing 593249
 Servicing A13Vi118



139453

Replacing 593289
 Servicing A14Vi15, -16, -27, -35



138500

Replacing 590607
 Servicing A13N166M



139444

Replacing 593244
 Servicing A13Vi97



139462

Replacing 593315
 Servicing A11Vi92, -93, -96, -97, -104, -105, A13Vi207, -208, -209, -210, -211, -212, -213, -216, -217, -218, -224, -227, -254, -255, -264, -265, -266, -267

Replacing VALEO / PARIS RHONE



139474

Replacing 593317
 Servicing A11Vi87, A13Vi 188, -235



230676

Replacing 593335
 Servicing A11Vi 88, -94, -98, -111, A13Vi 195



231095

Replacing 593352
 Servicing A13Vi234, A14Vi28



139480

Replacing 593322
 Servicing A13Vi178, -202, -237, -257



230943

Replacing 593354
 Servicing A13Vi190, -200



231096

Replacing 593416
 Servicing SG8B011, -013, -015, -016, -017, -018, SG9B013, -015, -018, -019, -023, -024, -049



139484

Replacing 593294
 Servicing A14Vi18, -24



231094

Replacing 593376
 Servicing A11Vi99, -101, -102, A13Vi236, -242, -246, -256



231097

Replacing 593417
 Servicing SG12B015, -042, -047, SG14B010

Replacing VALEO / PARIS RHONE



231100

Replacing 593398
 Servicing SG9B033, -035, -037,
 SG10B010, -011, -016, -019, -020



231933

Replacing 593370
 Servicing 2542234, SG12B012



233540

Servicing A14V07, -08, -14, -15, -16, -19



231187

Replacing 593234
 Servicing A13Vi78



232850

Servicing A14V17, -18



233594

Replacing 593341
 Servicing A13Vi193



231851

Replacing 593433
 Servicing 1440768, 2542433, 571527,
 HD90S013



232852

Servicing A14Vi11



233652

Servicing SG12B020

Replacing VALEO / PARIS RHONE



233654

Replacing 593448
 Servicing SG12B040



234111

Replacing 593510
 Servicing SG8B020, SG10B021, -023,
 SG12B055



234328

Servicing SG8B010, SG9B010, -011,
 -017, -042



233655

Replacing 593386
 Servicing SG12B017, -050



234148

Replacing 593479
 Servicing SG7S014, -024



234699

Replacing 593545
 Servicing SG7S015, -016



233772

Replacing 593242
 Servicing A11V110, -11, -23, -24, -25,
 -32, -33, -37, -40, -42, -43, -44, -45, -49,
 -51, -52, -53, -54, -55, -56, -57, -58, -76,
 -77, -86, A13V117, -22, -39, -48, -149



234232

Replacing 593336
 Servicing A13V1201



234750

Servicing 2518028, A13E50



Replacing VALEO / PARIS RHONE



234752

Servicing A13Vi140



234756

Servicing A13Vi130, -150



234762

Replacing 593513
Servicing SG15L012, -026



234754

Servicing A13Vi59



234758

Replacing 593436
Servicing SG12S019



234764

Replacing 593296
Servicing A14Vi17, -25



234755

Servicing A13Vi160, A14Vi22



234761

Replacing 593394, 593553
Servicing SG12B021, -023, -024, -027



234766

Replacing 593346
Servicing A14Vi23



Replacing VALEO / PARIS RHONE



234821

Replacing 593677
Servicing SG15S019



234983

Replacing 593531
Servicing SG8B021, -022, SG9B063, -064, -066, -067, SG10B022, -023



235168

Replacing 593504
Servicing SG8B023, -026, SG9B048, -55, -57



234822

Replacing 593528
Servicing SG15S016, -018, -021, -022



235069

Replacing 593407
Servicing A14Vi34, -46



235176

Replacing 593365
Servicing A11Vi95, A13Vi223



234966

Replacing 593361
Servicing A14Vi29, -52



235163

Replacing 593774
Servicing SG15S024, -031, TG15C020, -022, -023, -028



235197

Replacing 593442
Servicing SG9B037, -038, -039



Replacing VALEO / PARIS RHONE

235374

Replacing SG10B013, -14



236307

Replacing 593669
Servicing SG15L020, -027



236738

Replacing 593405
Servicing A14Vi37



235378

Replacing 593476
Servicing SG7S010, -012, -013, -028



236393

Replacing 593823
Servicing TG8C011



237798

Replacing 593507
Servicing SG7S020, -21



236103

Replacing 593810
Servicing TG9C013



236546

Replacing 593826
Servicing TG11C015, -014



238322

Replacing 593972
Servicing TG15C034, -056, -057, -B.C



Replacing VALEO / PARIS RHONE



238337

Replacing 593951
Servicing SG9B068, -079, TG11C021, -035



Regulators



130017

Replacing AYB 219
 12 V.
 Electronic, single phase



130657

Replacing 182046, 300868, YL 122, -129
Servicing A13N6, -12, -13, -14, -15, -17, -18, -19, -20, -27, -29, -30, -31, -49, -50, -53, -64, -65, -85, -86, -87, -89, -91, -97, -104, -106, -110, -113, -116, -120, -121
 12 V. For 6 diode alternators.



130632

Replacing AYC 2127, YL 413
 12 V.
 Electronic



130659

Replacing YL 120, -121, -127
Servicing A12R30, -31, -32, -37, A13R192, A14N26, -28
 12 V.



130655

Replacing 092867, 300669, YL 143
Servicing A12M9, -11, -16, -17
 12 V.
 For single phase, 2 diode alternators



130661

Replacing 182120, YH 1925, YL 133
Servicing A12R22, -24, -25, -33, -34, -44, -52, -53, A13N25, -32, -38, -39, -40, -41, -46, -47, -83, -94, -95, -109, -111, -118, -123, A13R203, -220, -248, -259, -262, -263, -266, -267, -268, A14N16, -18, -23
 12 V. For 9 diode alternators.

Replacing VALEO / PARIS RHONE



130663

Replacing YL 142
Servicing A12R36, -37, -38, -42, -46, A14N1, -2
 12 V.
 Alloy case

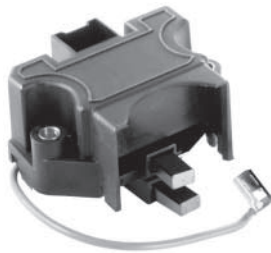

131120

Replacing 092962Y, ZL 128
Servicing A13N4T, -5T, -11, -22T, -174, -190, A14N39, -104, -133, -135, -138, A14R33
 24 V.



131226

Replacing 092966, 300741, YL 147
Servicing A13N1M, -2M, -28M, -35M, -55M, -57M, -58M, -66M, A14N29M
 12 V.

Adjustable voltage



130679

Replacing AYB 218
 12 V.
 Electronic, Triple Phase



131224

Replacing 592806, 2940318
Servicing A13E02, -03, -04, -05, -06, -07, -08, -09, -10, -11, -12, -13, -19, -2, -21, -22, -23, -24, -25, -26, -3, -4, -47, -48, -49, -5, -6, -7
 12 V.



131300

Replacing ZL 129, 300744
Servicing A13N33M, -36M, -59M, A14N30M, -47M, -81M, -122M, -137, -141M
 24 V.

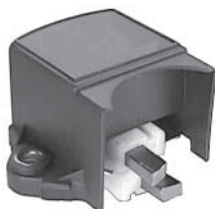

131077

Replacing 092857Z, ZL 120
Servicing A13R214, A14R10T, -14T
 24 V.



131146

Replacing 092990F, YL 139, YH 1639
Servicing A13N10, -43, -69, -76, -92, A14N9, -10, -22, -35, -36, -37, -55, -59, -73, -75, -76, -83, -84, -95
 12 V. For 6 diode alternators.



131477

Replacing 092991, 182007, 300663
Servicing A13N21T, -26, -52, -165, A14N11, -38
 12 V.

Replacing VALEO / PARIS RHONE



131553

Replacing 098288
Servicing A13R3L, -35L
 24 V.



133322

Replacing 092955, ZL 127
Servicing A12R35T, A14R34T, -54T,
 -341T, -541T, -542T, -543T
 24 V.



133783

Replacing 2541141
Servicing 2516046, 2518044,
 A13V02, -05, -07
 12 V.



132030

Replacing 097474, ZL114
Servicing A13R113T, -182TE
 24 V.



133379

Replacing 2541137, YH 1655
Servicing A12R36, -43, -45, A13R218,
 -221, -222, -228, -230, -231, -242, -243,
 -247, -255, -256, -258, -260, A14R25T,
 -45
 12 V.



133989

Replacing 182008, YV3932
Servicing A13N51
 24 V.



133028

12 V.
 Same as Cargo 130661, but
 w/ diagnostic terminals
 For UK marked

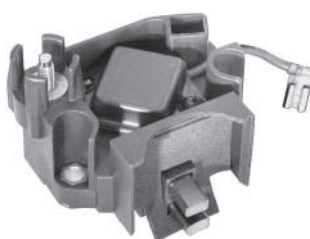

133492

Replacing 590688, YV1926T
Servicing A13N184, A14N139
 12 V.



134015

Replacing 300871, YH2700
Servicing A13N82, A14N11, -38, -67, -71
 12 V.

Replacing VALEO / PARIS RHONE

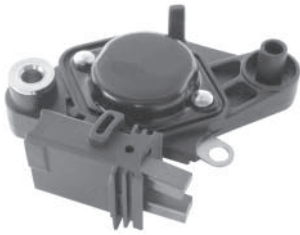

134475

Replacing 592791, YV1965T
Servicing A11Vi10, -11, -16, -17, -18, -23, -24, -25, A13Vi48, -49
 12 V.

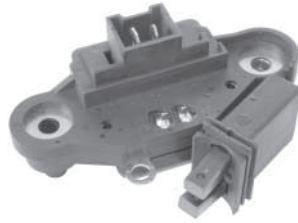

135513

Replacing 592802, YV1668H
Servicing A13Vi13, -28, -30, -52
 12 V.

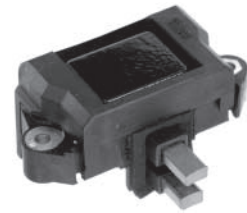

136942

Replacing 592963, YV49
Servicing A14V16, -19
 12 V.

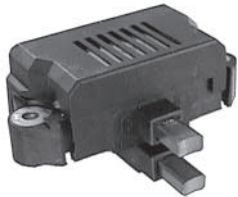

135393

Replacing 592781, YV9911
Servicing A14V01, -02, -03, -04, -05, -13
 12 V.



136546

Replacing YM 6951, 593138
Servicing A13Vi72, -73
 12 V.



136965

Replacing 592952, YV99
Servicing A14V07, -08, -09, -10, -11, -12, -14, -15, -17, -18
 12 V.



135434

Replacing 592793, YV1667H
Servicing A13Vi11, -14, -16, -17, -20, -21, -23, -25, -32, -34, -35, -45, -47, A11Vi28, -31
 12 V.

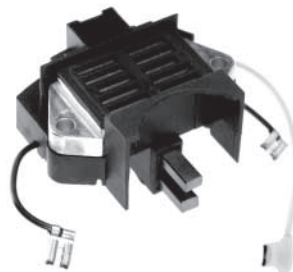

136910

Replacing 593135, YV7736
Servicing A13N234, -259, -285,
 Volvo Penta
 12 V.



137047

Replacing 098958, ZL412
 24 V.

Replacing VALEO / PARIS RHONE

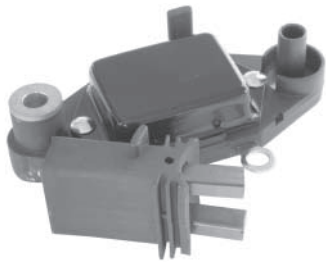

137489

Replacing 593260, ZV3960H
Servicing A14Vi19
 24 V.



139440

Replacing 593316, -338, YM1424P1
Servicing A11Vi87, -88, -94, -98,
 A13Vi 188, -195, -235, -238, -249, -251,
 -252, -253
 12 V.



139482

Replacing 593319
Servicing A13Vi178, -202, -237, -257
 12 V.

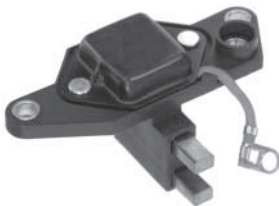

137694

Replacing 592602, YV5914H
Servicing A13E01, -17, -50
 12 V.



139456

Replacing 593290, 593310, 593349
Servicing A11Vi79, -81, -85, -92, -93, -96, -
 97, -104, -105, A13Vi157, -163, -164, -165, -
 166, -167, -179, -184, -185, -201, -207,
 -208, -209, -210, -211, -212, -213, -216
 12 V.

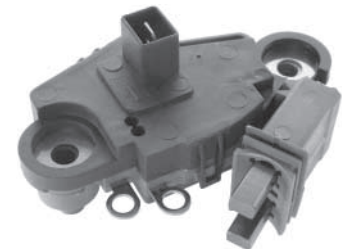

139486

Replacing 593305, YV1060P
Servicing A13Vi152
 Volvo
 12 V.



138301

Replacing 593141, YM1601T
Servicing A11Vi54, -76, -77, A13Vi117,
 -118, -122, -139, -148, -149
 12 V.



139475

Replacing 593132, YV10673H
Servicing A13Vi97
 12 V.

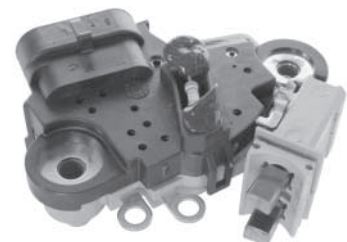

230686

Replacing 593339, YM 2612P2
Servicing A13Vi192, -193
 12 V.

Replacing VALEO / PARIS RHONE

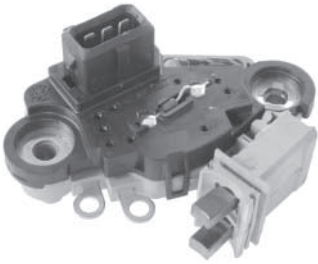

230944

Replacing 593353, YM 10616PIC
Servicing A13Vi150, -160, -190, -200
 12 V.

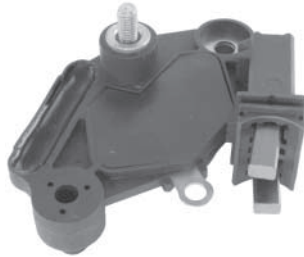

232042

Replacing 593375, YM6956
Servicing A11Vi99, -101, -102,
 A13Vi236, -242, -246, -256
 12 V.

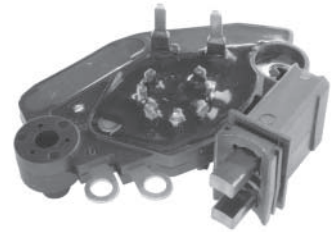

233633

Replacing 593419
Servicing A11Vi106, -108, A13Vi276,
 -278, -288
 12 V.

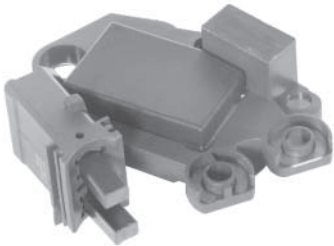

231103

Replacing 593455, YM 1672 VFP1
Servicing SG8B010, -011, -013, -015,
 -016, -017, -018, SG9B010, -011, -013,
 -015, -018, -019, -023, -024, -029, -042,
 SG12B010, -011, -015, -018, -042, -047
 12 V.



232043

Replacing 593430, ZV3963T
Servicing HD90S013, -014, -015
 24 V.

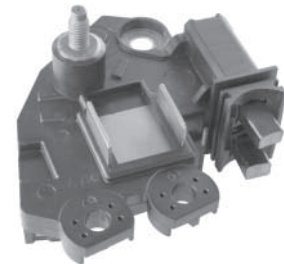

234115

Replacing 593534, 593477, YR66P
Servicing SG7S014, -024, SG8B020,
 SG10B021
 12 V.

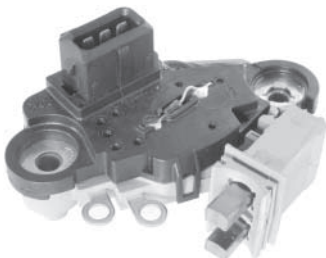

231663

Replacing 593347, YM2618P1
Servicing A14Vi22, -28, -29
 12 V.



232962

Replacing 593384, 593396, YM 1636P1
Servicing SG9B033, -047, SG10B010,
 -011, -016, -019, -020, -031, -032,
 SG12B017, -030
 12 V.
Insulator plug: Cargo 238201

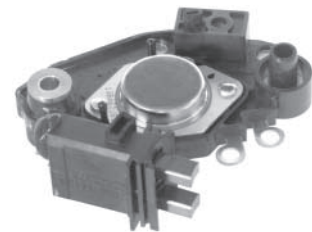

234533

Replacing 593362, YM 1610F
Servicing A11Vi95, A13Vi223, -241
 12 V.

Replacing VALEO / PARIS RHONE



234818

Replacing 593689, YR1615PF
Servicing SG12B052, -071, -081,
 TG11C010, -011, -022
 12 V.

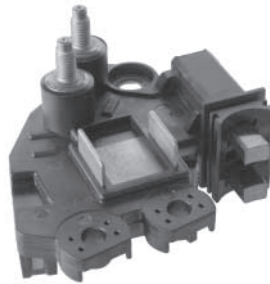

234982

Replacing 593529, YR6620PF
Servicing SG7S016, SG8B021, -022,
 SG9B063, -064, -066, -067, SG10B022
 12 V.



235229

Replacing 593779, YM6670VF
Servicing A13Vi278, SG15L012, -26
 12 V.

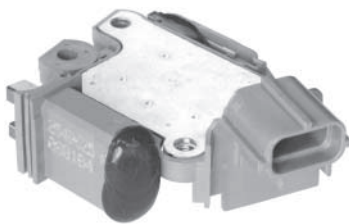

234820

Replacing 593675, YH0601
Servicing SG15S019, TG9C013,
 TG12C013
 12 V.

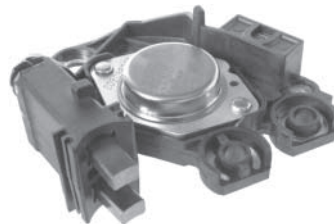

235079

Replacing 593434, 593446, YM1658
Servicing SG9B054, SG12B040, -54
 SG12S019
 12 V.



235369

Replacing 593406, YM3634VFP2
Servicing A14Vi34, -45, -46, -47, -134
 12 V.

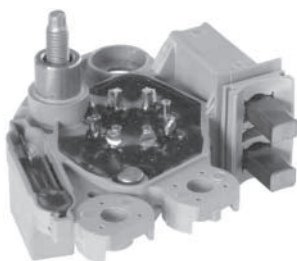

234961

Replacing 593454, YM1666FP5
Servicing SG9B037, -038
 12 V.

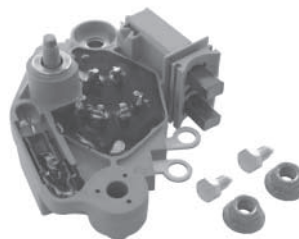

235082

Replacing 593284, YM6603
Servicing A14Vi15, -16, -27, -41, -42,
 2542500
 12 V.



236306

Replacing 593666, YM1689PF
Servicing SG15L020, -027
 12 V.
 DF terminal



Replacing VALEO / PARIS RHONE

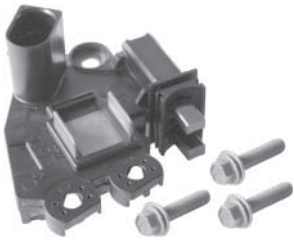

236597

Replacing 593780, YR0636D15
Servicing SG12B062, TG15C018
 12 V.
 Brush set: Cargo PX60 2



Regulator Parts



134144 A

For regulator Cargo 131120
 Connection



238201

Servicing 593384, 593396, 593458,
 593546, Cargo 232962
 Insulator plug



236601

Replacing 593793, YR3632VFP2
Servicing TG15C012
 12 V.



Rectifiers



131164 HD

Replacing 104971, 592595, 592779
Servicing A13N39, -46, -47, -109, -123,
 -129, -133, -138, -178, -179, NP203
 105 Amp.
 W/ diode trio and capacitor
 Aluminium heat sink



131228

Replacing 180593
Servicing A13N6, -7, -12, -13, -14, -15,
 -17, -27, -29, -30, -49, -50, -53, -64, -65
 105 Amp.
 W/ capacitor
 Aluminium heat sink

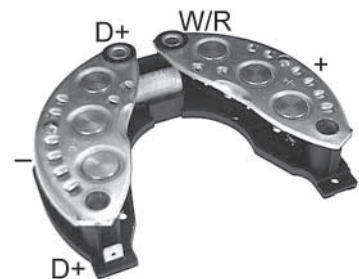

131568

Replacing 101701, 104269
Servicing A13N11, -44T, -45T, -174,
 A14N39, -133, -135
 150 Amp.
 W/ diode trio, capacitor, W terminal
 Aluminium heat sink

Replacing VALEO / PARIS RHONE

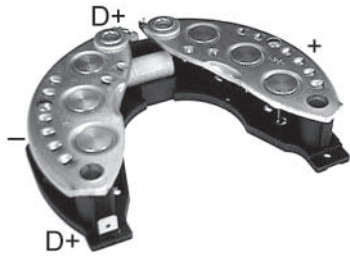

131569

Replacing 102339, 103546
Servicing A13N26, -32, -38, -40, -41, -42, -83, -93, -94, -99, -100, -101
 105 Amp.
 W/ diode trio, capacitor, resistor 82 Ohm (D+/-)
 Aluminium heat sink



131575

Replacing 079649
Servicing A13R63, -73, -73T, -74, -78T, -80T, -81T, -82T, -83, -83T, -85, -85T, -86, -86T, -87, -88, -88T, -89, -89T, -90, -90T, -97T, -99, -115, -121, -140, -141, -145
 75 Amp.



131578

Replacing 092086
Servicing A11R1, -2, -3, -4, A12R1, -2, -3, -4, -6, -8, -9, -10, -11, -12, -13, -14, -16, -17, -19, -20, -21, -22, -23, -24, -25, -26,
 75 Amp.
 6 diodes

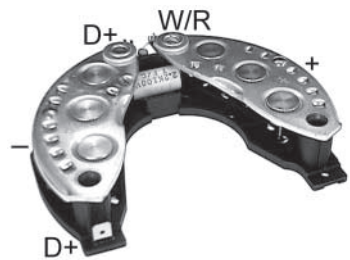

131570

Replacing 101342
Servicing A13N4T, -5T, -22T, -61T
 150 Amp.
 W/ diode trio, capacitor, resistor 330 Ohm (D+/-), W terminal
 Aluminium heat sink



131576

Replacing 092733, 103630
Servicing A13R192, -203, -214, -218, -220, -221, -222, -228, -230, -231, -242, -243, -244, -245, -247, -255, -256, -260, -262, -263, -269, -270, A14R3, -7, -8T, -9T
 75 Amp.

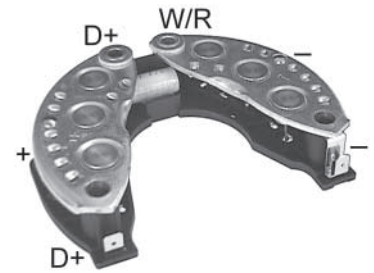

131701 HD

Replacing 103551, 181155, 593199
Servicing A13N1M, -2M, -28M, -33M, -34, -35M, -36M, -51, -52, -55M, -57M, -66M
 150 Amp.
 W/ diode trio and capacitor
 Aluminium heat sink

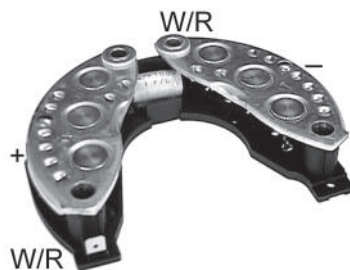

131573

Replacing 106016
Servicing A13N81, -90, -107, -108, -112, -117, -119, -164, -185, A14N4, -53, -54
 105 Amp.
 W/ capacitor
 Aluminium heat sink



131577

Replacing 092734
Servicing A11M10, -14, A12M1, -2, -3, -6, -7, -10, -18
 75 Amp.
 4 diodes

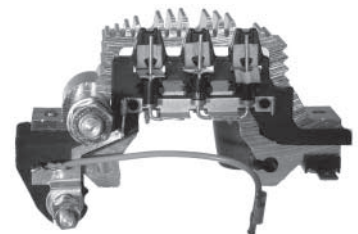

132938

Replacing 2523321
Servicing A13E02, -03, -04, -05, -06, -07, -08, -09, -10, -11, -12, -13, -21, -22, -26, -43, -47, -48, -49, -54, -58
 W/ diode trio

Replacing VALEO / PARIS RHONE

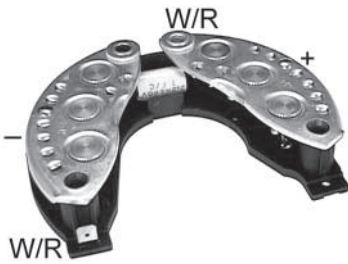

132985 HD
Replacing 105690
Servicing A13N88, -171, A14N62
 105 Amp.
 W/ capacitor
 Aluminium heat sink

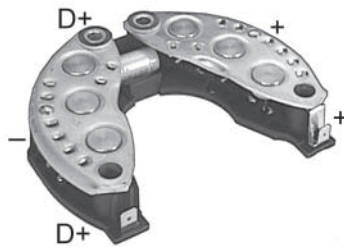

133687
Replacing 101713
Servicing A14N11, -38, -71
 105 Amp.
 W/ diode trio capacitor and
 Aluminium heat sink

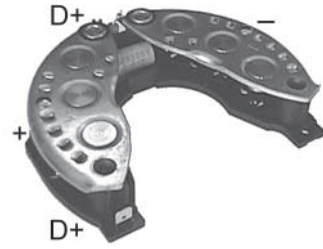

133741 HD
Replacing 103813, 105814, 592741
Servicing A13N16, -80, -95, -167
 105 Amp.
 W/ diode trio, capacitor, resistor 82 Ohm (D+/-)
 Aluminium heat sink

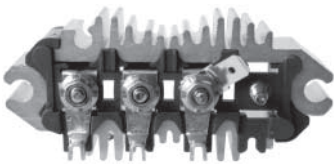

133432
Replacing 300903
Servicing A14N67, -73, -75, -76, -95,
 -104, -124, -140
 6 diodes



133689
Replacing 105135, 105629
Servicing A13N10, -18, -19, -20, -31, -43,
 -82, -84, -87, -91, -92, -103, -106, -113
 105 Amp.
 W/ capacitor
 Aluminium heat sink

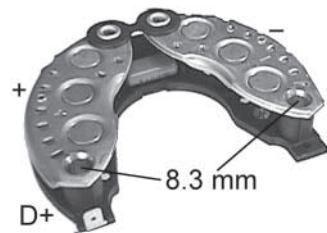

133882
Replacing 592753, 592878
Servicing A13N217, -184, A14N139, -172
 105 Amp.
 W/ diode trio and capacitor

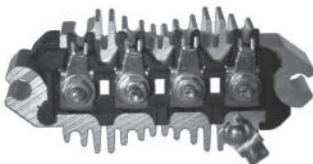

133433
Replacing 300903
Servicing A14N67, -73, -75, -76, -95,
 -104, -124, -140
 8 diodes

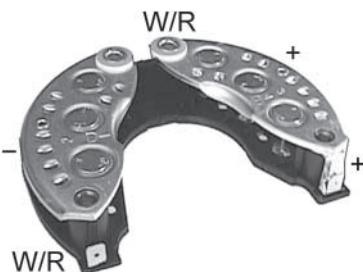

133691
Replacing 102817
Servicing A13N62, -69, -76, A14N19, -37
 105 Amp.
 Aluminium heat sink

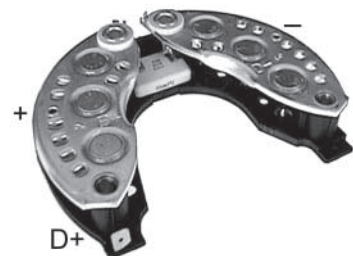

134098
Replacing 592747, 592749
Servicing A13N151, -177, -181, -182,
 -183, -218, -220
 105 Amp.
 W/ diode trio and capacitor
 Aluminium heat sink

Replacing VALEO / PARIS RHONE



135278

Replacing 592848
Servicing A11Vi15, -16, -17, -18, -47, -48, -91, -99, -101, -102, A13Vi31, -39, -48, -85, -86, -87, -94, -95, -101, -102, -203
 6 diodes, w/ diode trio
 B+ terminal M8 x 20 mm



135427

Replacing 592844, 592917
Servicing A13Vi24, -67, -69, -70
 6 diodes, w/ diode trio
 B+ terminal M8 x 25 mm

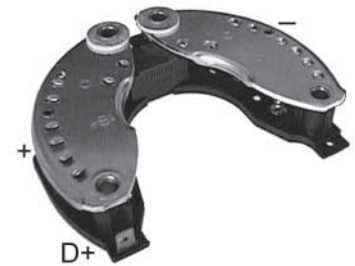

136343

Replacing 592840
Servicing A13N214, -243

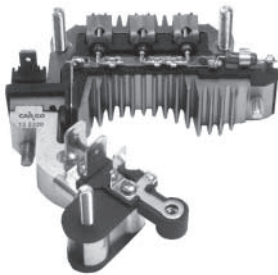

135320

Replacing 592838
Servicing A13V02, -05, -07
 Mercedes
 6 diodes, w/ diode trio



135494

Replacing 592845
Servicing A11Vi89, A13Vi46, -49, -51, -68, -71, -80, -81, -83, -84, -88, -96, -108, -109
 6 diodes, w/ diode trio
 B+ terminal M8 x 25 mm

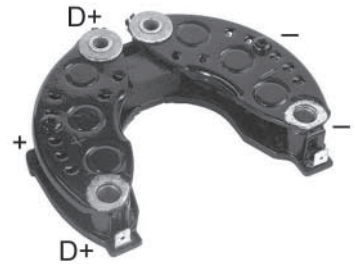

136883

Replacing 592882
Servicing A14N183

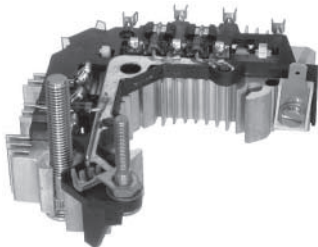

135394

Replacing 592700
Servicing A14V01, -02, -03, -05
 12 diodes, w/ diode trio
 B+ terminal M8 x 35 mm



135518

Replacing 592846, -47
Servicing A11Vi28, -31, A13Vi14, -16, -17, -20, -23
 8 diodes,
 B+ terminal M6/8 x 33 mm

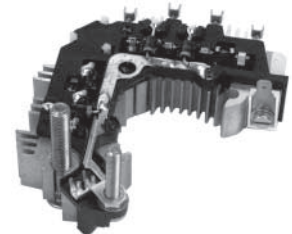

136939

Replacing 592835
Servicing A14V13
 12 diodes, w/ diode trio
 B+ terminal M8 x 54 mm

Replacing VALEO / PARIS RHONE

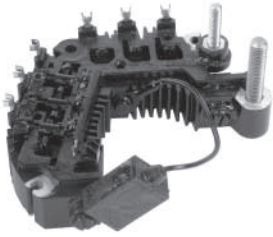

136943

Replacing 592959
Servicing A14V09, -12, -16, -19
 B+ terminal M8 x 35 mm
 D+ terminal M6 x 23 mm



137524

Replacing 593175
Servicing A11Vi54, -76, -77, -79, -92, -93, -97, -104, A13Vi149, -165, -166, -184, -207, -208, -211, -212, -213, -217
 6 diodes
 B+ terminal M6 x 27 mm



138596

Replacing 592842
Servicing A13Vi126
 6 diodes, w/ diode trio
 W/ terminal W
 B+ terminal M8 x 28 mm

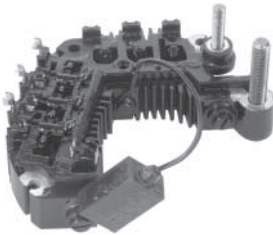

136966

Replacing 592956
Servicing A14V07, -08, -10, -11, -14, -15, -17, -18

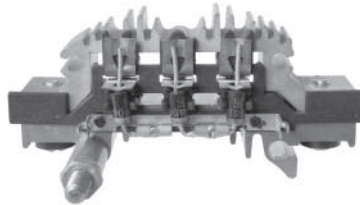

138115

Replacing 592893
Servicing 2541235, A13E 25, -50

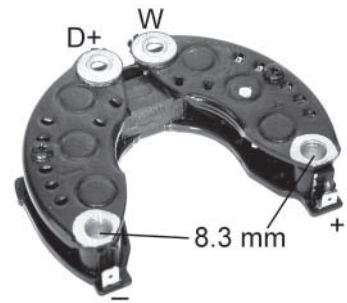

139443

Replacing 593181
Servicing A14N182, -185, -190
 6 diodes
 W/ diode trio and capacitor

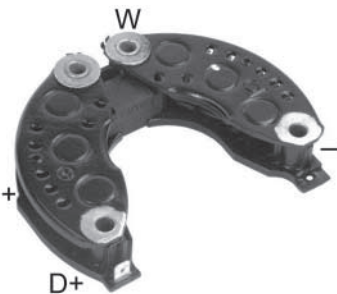

137164

Replacing 592951
Servicing A13N207



138303

Replacing 593174
Servicing A13Vi118
 8 diodes
 B+ terminal M8 x 26 mm



139472

Replacing 593202
Servicing A14Vi10, -11, -13, -14, -130, -131
 8 diodes, w/ diode trio
 B+ terminal M8 x 25 mm

Replacing VALEO / PARIS RHONE



139481

Replacing 593320
Servicing A13Vi178, -202, -237, -257
 6 diodes,
 B+ terminal M8 x 25 mm



231166

Replacing 593167
Servicing A13Vi72, -73
 B+ terminal M8 x 33.5 mm



232044

Replacing 594431
Servicing HD90S013, -014, -015
 B+ terminal M8 x 31 mm
 W terminal M5 x 12 mm



139483

Replacing 593205
Servicing A14Vi19, -20
 B+ terminal M8 x 26 mm
 D+ terminal M5 x 12 mm



231396

Replacing 593172
Servicing A13Vi117, -122, -139, -148, -164, -167, -209, -210, -216, -264, -265
 8 diodes
 B+ terminal M6 x 27 mm



232199

Replacing 593287
Servicing A14Vi15, -16, -27, -35, -41, -42
 B+ terminal M8 x 13 mm



230031

Replacing 593327
Servicing A13Vi188, -192, -193, -195
 8 diodes
 B+ terminal M8 x 31 mm



231736

Replacing 592915
Servicing A11Vi21, -22, -35, -36, -62, -66, A13Vi18, -40, -41, -44, -54, -60, -61, -114, -121, -123, -124, -125, -132, -140
 6 diodes, w/ diode trios
 B+ terminal M8 x 23 mm

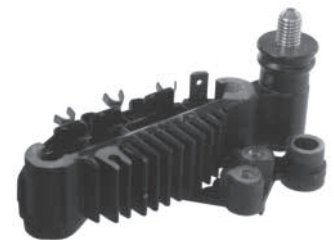

233614

Replacing 593345
Servicing A14Vi23, -29
 150 Amp.
 B+ terminal M8 x 12 mm

Replacing VALEO / PARIS RHONE



235258

Replacing 593165
 Servicing A13Vi82
 B+ terminal M8 x 34



235386

Replacing 593393
 Servicing SG12B021, -023, -024, -027,
 -047, -060, -062, -071, -075, -096



Rectifier Parts



233593

Servicing 592845, Cargo 135494
 Insulator



235270

Replacing 593293, 593337
 Servicing A13Vi201, A14Vi18, A14Vi24
 B+ terminal M8



133739 Std pkg 10 **A**

Servicing A13N...
 M5 x 50 mm
 B+ terminal



133740 Std pkg 10 **A**

Servicing A13N...
 M6 x 60 mm
 B+ terminal



235354

Replacing 593206
 Servicing A13Vi113
 O.D 107 mm. 8 diodes w/diode trio
 W/ w-6.3 terminal
 B+ terminal M6 / 8 x 34



134793 Std pkg 10

Servicing A13N...
 M6 x 50 mm
 B+ terminal

Replacing VALEO / PARIS RHONE



137578

Servicing A13N137, -178
M5 x 46 mm
B- terminal



234008 Std pkg 5

Servicing A14Vi23, -27, -29, -35, -41, -42
M5 x 35 mm, head 10.3 x 13 mm
D+, W terminal, insulated head



234013 Std pkg 5

M6 x 49 mm, head 12.3 x 12.3 mm,
KNURL O.D. 6.5 mm
B+ terminal, insulated head



235230

Servicing A14N73, -75, -124, -140, -160
M6 x 42.6 mm
B+ terminal



234009 Std pkg 5

Servicing A13N...
M5 x 45 mm, head 10.3 x 13 mm
B+ terminal, insulated head

235152

Servicing A13N 10, -28, -38, -40, -41, -42, -43, -46, -52, -84, -95, -129, -144, -147, -151, -167, -175, -177, -182, -215, -216, -218, -219, -220, -239, -247, -259, -261,
M6
Nut



236205

Servicing A14N104, -138, -160
M4
W terminal



234010 Std pkg 5

Servicing A13N...
M6 x 49 mm, head 12.3 x 12.3 mm
B+ terminal, insulated head

236699

Servicing A14N160
L. 25.07 mm
O.D. M8, I.D. M6
Connector



236206

Servicing A14N104, -138, -160
M5
D+ terminal



234012 Std pkg 5

M5 x 36 mm, head 10.2 x 13 mm,
KNURL O.D. 5.5 mm
B+ terminal, insulated head

238001

Servicing A14Vi15, -16, -25, -27, -35, -41, -48
23.25 x 10 mm
Connector



Replacing VALEO / PARIS RHONE



235215

Servicing A13N2M, -20, -35M, -56M, -95, -147, -147M, -148M, -149M, -234, -259, -259M, -283, -283M, A13R203, -221, -222, -231, -243, A14N30M, -47M, 73M, -75M, M5, W. 10 mm
Nut



235216

Servicing A13N1M, -2M, -4T, -5T, -22T, -28, -52, -56M, -147, -147M, -148M, -149M, 229T, -259, -259M, -281, -283, -283M, A14N4, -30M, -47M, -100, -100M, -112M M4/M5, W. 17.24 mm
Nut



235217

Servicing A13N..., A14N...
M5, 7 mm
Nut



235379

Servicing A14N67, -73, -75, -104, -124, -138, -140, -160
100 V.
4.7 UF
Capasitor

Diode Trios



131580

Replacing 095106
Servicing A13R83, -84, -85, -86, -87, -88, -89, -90, -97, -98, -117, -121, -124, -127, -129, -131, -133, -134, -140, -143, -169, -170, -173, -175, -176, -179, -183, -184, -187, -219, -223, -261, -265



132579

Replacing 099520
Servicing A14R35, -41



132675

Replacing 096424
Servicing A13R83T, -85T, -86T, -88T, -89T, -90T, -162T, -163T, -172T, -179T, -188T, -191T, -194, -195, -196, -202, -215, -224, -225

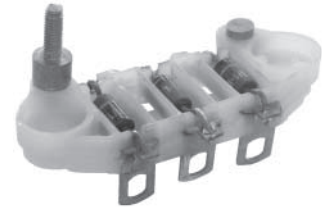

132676

Replacing 097207
Servicing A11R3, -56



132998 Std pkg 5

Replacing 092425
Servicing A11R4, A12R9, -12, -16, -17, -23, -27, -28, -48, -59



132999

Replacing 100125
Servicing A12R30, -31, -32, -37

Also see Diode Chapter
page 780

Replacing VALEO / PARIS RHONE



133000

Replacing 100721
Servicing A12R25, -33, -34, -44, -52, -53

Diodes



234350 Std pkg 10
50 Amp. Avalanche
12.8 mm press fit
32-40 V.
Negative



234351 Std pkg 10
50 Amp. Avalanche
12.8 mm press fit
32-40 V.
Positive

Slip Rings



130841 Std pkg 10
Replacing 34100328
Servicing A13M11
O.D. 36 mm, Shaft 17 mm, L 22.5 mm



130842 Std pkg 10 **A**
Replacing 49100327
Servicing A11R1, A11M6
O.D. 30 mm, Shaft 15 mm, L 21.4 mm



131814 Std pkg 5 **A**
Servicing A13N . . , A14N . .
O.D. 30 mm, Shaft 17 mm, L. 28 mm



131815 Std pkg 5 **A**
Servicing A13N . . , A14N . .
O.D. 30 mm, Shaft 15 mm, L. 27 mm

Replacing VALEO / PARIS RHONE



132295 Std pkg 10 **A**
Servicing A13N . . , A14N . .
 O.D. 30 mm, Shaft 17 mm, L. 28 mm



135179 Std pkg 5
Servicing A11Vi . . , A13Vi . .
 Alternators w/ internal fan
 O.D. 14.9 mm, Shaft 6.8/8.85, L. 27.8 mm
 O.E. Style: Cargo 230090



233498
Servicing 092956
 O.D. 29.6 mm, Shaft 17 mm, L. 31 mm



133351 Std pkg 5 **A**
 O.D. 34 mm, Shaft 17 mm, L. 23 mm
 6 splines



137574
Replacing 2523992
Servicing A13N1M, -35M, -147M, -148M,
 -149M
 O.D. 29.5 mm, Shaft 17 mm, L. 37.5 mm



132848 Std pkg 10 **A**
Servicing Cargo 131814, 131815, 132295
 Insulator for slip ring



134492 Std pkg 5
Servicing A13N . .
 O.D. 30 mm, Shaft 17 mm, L. 29 mm



138421 Std pkg 10
Servicing A11Vi . . , A13Vi . .
 O.D. 14.3 mm, Shaft 6.6/8.4, L. 27.8 mm



230432 Std kg 10
Servicing Cargo 131814, 131815, 132295
 Same as Cargo 132848, but 0.5 mm thick
 Insulator for slip ring



135173 Std pkg 10 **A**
Servicing A11Vi . . , A13Vi . .
 O.D. 14.9 mm, Shaft 7.9/8.75 mm, L. 24 mm
 Quick repair: Cargo 234489



230090 Std pkg 5
Servicing A11Vi . . , A13Vi . .
 O.D. 14.9 mm, Shaft 6.6/8.85 mm,
 L. 48.3 mm
 O.E. Style



133365 Std pkg 10 **A**
 27/30 x 8.4 mm
 Copper ring
 Quick repair for slip ring: Cargo 131814,
 131815

Replacing VALEO / PARIS RHONE



133366 Std pkg 10 **A**
 27/30 x 10 mm
 Copper ring
 Quick repair for slip ring: Cargo 131814, 131815



234489 Std pkg 100
 13/15 x 9.4 mm
 Copper ring
 Quick repair for slip ring: Cargo 131819, 135173, 135179, 230090

Brush Boxes



130708
 Replacing 096334
 Servicing A13M2, -5, -7, -8, -11, -14, -15, -16, -17, A13R63, -73, -74, -78, -80, -81, -82
 Complete w/ brushes



130710
 Replacing 078118
 Servicing A11M7, -10, -11, -12, -13, -14, A11R1, -2, -3, A13R83, -85
 Complete w/ brushes



130711
 Replacing 095788
 Servicing A13M3, -6, -9, -12, -134
 Complete w/ brushes



130966
 Replacing 098627
 Servicing A12R30, -31, -32, -37, A13R192, A14R10T, -26, -28, -41
 Complete w/ brushes



131555
 Replacing 096322
 Servicing A12M5
 Complete w/ brushes



131557
 Replacing 092859
 Servicing A12M..., A12R..., A13N..., A13R..., A14N..., A14R...
 Complete w/ brushes



131850
 Replacing 300665
 Servicing A13N4T, -5T, -11, -21T, -22T, -61T, A14N32T, -39, -104, A14R33, -39T
 Complete w/ brushes



132328
 Replacing 096304
 Servicing A13R121, -133, -134
 Complete w/ brushes

Replacing VALEO / PARIS RHONE



134928
 Replacing 300682
 Servicing A14N28T, -3T



137192
 Replacing 092967
 Servicing A13N1M, -2M, -28M, -33M,
 -35M, -36M, -55M, -56M, -57, -58M, -59M
 Complete w/ brushes

Brush Sets



141006
 Servicing A14Vi 19, -20, 2541873, -916
 24 V.
 4.5 x 6.3 x 13 mm



PX50 2 Std pkg 10
 Replacing 073742R
 5 x 7 x 14 mm
 6/24 V.



PX52-54 2 Std pkg 10 **A**
 Replacing 75411H
 5 x 7 x 19 mm
 12 V.



PX58 2 Std pkg 10 **A**
 Replacing 300665
 Servicing A14R33, -39T
 5 x 10 x 17 mm
 12/24 V.



PX60 2 Std pkg 10 **A**
 Replacing 092950
 4.6 x 6.35 x 15.4 mm
 12 V.

Replacing VALEO / PARIS RHONE

Also see Bearing Chapter
and Pulley Survey

Special Bearings



140263 Std pkg 10 **A**

Replacing 592905, -36, 593674
Servicing A14Vi...
17/52 x 17 mm



140401 Std pkg 5 **A**

Replacing 102130
Servicing A13N33M, -34M, A14N47M
17/62 x 17 mm



140441 Std pkg 16 **A**

Replacing 593690
Servicing A11Vi. . ., A13Vi
15/32 x 11 mm

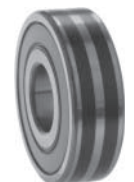

140839 Std pkg 10

Replacing 593691, 6203 LHA
Servicing A13Vi
15/40 x 12 mm

Fan & Pulleys



131486

Replacing 101042
Servicing A12R. ., A13N. ., A13R. .
O.D. 128 mm, Bore 17 mm
Fan



133091

Replacing 079627
Servicing A12R. ., A13M. ., A13N. .
O.D. 135 mm, Bore 17 mm
Fan kit



131842

Servicing A13N30, -89, -120
O.D. 56 mm, Bore 17 mm, W. 23.2 mm,
5 grooves



133624

Replacing 104377
Servicing A13N27, -29, -86, A14N40
O.D. 68 mm, Bore 17 mm, W. 20.5 mm,
4 grooves



133625

Replacing 105500
Servicing A14N76, -96
O.D. 74.5 mm, Bore 17 mm, W. 24.3 mm,
5 grooves



133626

Replacing 181736
Servicing A13N136, -137, -139, -160
A14N124, -125
O.D. 67.3 mm, Bore 17 mm, W. 27.3 mm,
5 grooves



133742

Replacing 181202
Servicing A13N 124, -125, -128, -133,
-161, -172, -178, -180, -199, -201,
A14N101, -102
O.D. 55.2 mm, Bore 17 mm, W. 28.7 mm,
6 grooves



133870

Replacing 105760
Servicing A13N162, -164, -206
O.D. 59.6 mm, Bore 17 mm, W. 29.6 mm,
6 grooves

Also see Pulley Survey
page 809

Replacing VALEO / PARIS RHONE



133936

Replacing 096880

Servicing A12R2, -37, -44, -53, A13N6, -7, -10, -12, -13, -15, -19, -20, -38, -42, -43
O.D. 64.5 mm, Bore 17 mm, W. 16.4 mm, Single



135520

Replacing 101978, 592756

Servicing A13N95, -218, -220
O.D. 56.1 mm, Bore 17 mm, W. 23.1 mm, 4 grooves



135745

Replacing 593733

Servicing A11Vi15, -16, -17, -40, -42, -47, -51
O.D. 62.4 mm, Bore 17 mm, W. 28 mm, 6 grooves



134919

Replacing 183125

Servicing A13N179, -233
O.D. 54.9 mm, Bore 17 mm, W. 19 mm, 3 grooves



135530

Replacing 592927

Servicing A13Vi17
O.D. 60.2 mm, Bore 17 mm, W. 42.8 mm, 4 grooves



136150

Replacing 592925

Servicing A13Vi25
O.D. 57.5 mm, Bore 17 mm, W. 53.6 mm, 6 grooves



135512

Replacing 592928

O.D. 58.2 mm, Bore 17 mm, W. 39.7 mm, 3 grooves



135560

Replacing 592921

Servicing A13Vi11, -23, -32
O.D. 58.2 mm, Bore 17 mm, W. 36.3 mm, 6 grooves



136153

Replacing 592922

Servicing A11Vi26, -88, -92, -97, -104
O.D. 55.2 mm, Bore 17 mm, W. 33.5, 6 grooves



135519

Replacing 592930

Servicing A11Vi18, A13Vi48
O.D. 56.2 mm, Bore 17 mm, W. 24.6 mm, 4 grooves



135744

Replacing 101344

Servicing A13N21T, -22T
O.D. 83 mm, Bore 17 mm, W. 30.9 mm, Double



136154

Replacing 592923

Servicing A13Vi20, -21
O.D. 61.7 mm, Bore 17 mm, W. 34 mm, 4 grooves

Replacing VALEO / PARIS RHONE

Also see Pulley Survey
page 809



136198

Replacing 592885
Servicing A14N156
O.D. 63.8 mm, Bore 17 mm, W. 23.8 mm,
3 grooves



136364

Replacing 096879
Servicing A12R8, -9, -21, -23, -32, -33,
-34, -36, -45, -47, -48, -49, -52, A13N32
O.D. 71.4 mm, Bore 17 mm, Single



137701

Replacing 593750
Servicing A13Vi62, -66
O.D. 55 mm, Bore 17 mm, W. 42.7 mm,
6 grooves



136349

Replacing 593742
Servicing A11Vi31, -44, -45, -52
O.D. 56 mm, Bore 17 mm, W. 25.6 mm,
5 grooves



136937

Replacing 593602
Servicing A13Vi54, 2541454
O.D. 50.1 mm, Bore 17 mm, W. 49.3 mm,
6 grooves



138657

Replacing 593747
Servicing A13Vi107, 2541788
O.D. 63.7 mm, Bore 17 mm, W. 28.1 mm,
3 grooves



136350

Replacing 593740
Servicing A13Vi30, -55
O.D. 62 mm, Bore 17 mm, W. 26.1 mm,
4 grooves



136958

Replacing 593702
Servicing A13Vi81
O.D. 56.1 mm, Bore 17 mm, W. 29.8 mm,
6 grooves



139136

Replacing 593711, 593720
Servicing A13Vi138, -156
O.D. 55.9 mm, Bore 17 mm, W. 34.9 mm,
5 grooves



136351

Replacing 593701
Servicing A13Vi72
O.D. 54 mm, Bore 17 mm, W. 39.5 mm,
6 grooves



137031

Replacing 592919
Servicing A13Vi18
O.D. 48.1 mm, Bore 17 mm, W. 29.7 mm,
5 grooves



230288

Replacing 593754
Servicing A11Vi91, 2541969
O.D. 54 mm, Bore 17 mm, W. 25.9 mm,
6 grooves

Also see Pulley Survey
page 808

Replacing VALEO / PARIS RHONE



230293 A

Replacing 593600, F-227628.5, -7
Servicing SG8B013, SG9B015,
SG12B015, TG14C011
O.D. 56.1 mm, Bore 17 mm, W. 41.6 mm,
6 grooves, w/ Free wheel
Pulley tool: Cargo 210843



230297

Replacing 593492, F-226954.3
Servicing A13Vi202
O.D. 49.7 mm, Bore 17 mm, W. 48.9 mm,
5 grooves, w/ Free wheel
Pulley tool: Cargo 210909
Cap: Cargo 231452



230310

Replacing 2547737, F-230759.1
Servicing Mercedes
O.D. 51.9 mm, Bore 17 mm, W. 48 mm,
5 grooves, w/ Free wheel
Pulley tool: Cargo 210909



230309

Replacing F-230147.3
Servicing TG11C011
O.D. 56 mm, Bore 17 mm, W. 36.9 mm,
5 grooves, w/ Free wheel
Pulley tool: Cargo 210843



230522

Replacing 593515, F-228881.2
Servicing SG10B019, -032
O.D. 55.8 mm, Bore 17 mm, W. 40.1 mm,
6 grooves, w/ Free wheel
Pulley tool: Cargo 210909

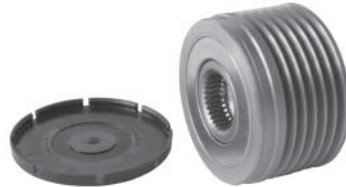

230523

Replacing 593521, F-229603.14
Servicing A14Vi 35
O.D. 54.4 mm, Bore 17 mm, W. 34.8 mm,
6 grooves, w/ Free wheel
Pulley tool: Cargo 210909



230524

Replacing 593514, 2547655, F-229643.4
Servicing SG12Bo17 Renault
O.D. 48.8 mm, Bore 17 mm, W. 37.8 mm,
6 grooves, w/ Free wheel
Pulley tool: Cargo 210909



231584

Replacing 593610
Servicing SG9B033, SG10B016, -020
O.D. 54.25 mm, Bore 17 mm, W. 41.6 mm,
6 grooves



231633

Replacing 593739
Servicing A13Vi47
O.D. 50.9 mm, Bore 17 mm, W. 38.8 mm,
6 grooves



231634

Replacing 593699
Servicing A13Vi78
O.D. 51.5 mm, Bore 17 mm, W. 56.2 mm,
6 grooves



231636

Replacing 593719
Servicing A13Vi70, -155
O.D. 65.2 mm, Bore 17 mm, W. 32.5 mm,
6 grooves



231846

Replacing 593699, 593730
Servicing A13Vi178, -237, 2542291
O.D. 52 mm, Bore 17 mm, W. 42.5 mm,
5 grooves

Replacing VALEO / PARIS RHONE

Also see Pulley Survey
page 809



231857

Replacing 593728
Servicing A14Vi28
O.D. 53.7 mm, Bore 17 mm, W. 32.2 mm,
5 grooves



232345

Replacing 593745
Servicing A13Vi94
O.D. 62.8 mm, Bore 17 mm, W. 30.1 mm,
6 grooves



232353

Replacing 593727
Servicing A13Vi190
O.D. 52.5 mm, Bore 17 mm, W. 30.6 mm,
6 grooves



232333

Replacing 593737
Servicing A13Vi123
O.D. 49.4 mm, Bore 17 mm, W. 41.3 mm,
6 grooves



232346

Replacing 593695
Servicing A13Vi61
O.D. 68.9 mm, Bore 17 mm, W. 53.7 mm,
Single



232355

Replacing 593755
Servicing A13Vi234
O.D. 54 mm, Bore 17 mm, W. 37.3 mm,
5 grooves



232335

Replacing 593708
Servicing A13Vi97
O.D. 53.3 mm, Bore 17 mm, W. 29.9 mm,
5 grooves



232349

Replacing 593519
Servicing A13Vi236
O.D. 57.3 mm, Bore 17 mm, W. 26.5 mm,
6 grooves



232357

Servicing A13N275
O.D. 89 mm, Bore 17 mm, W. 34.4 mm,
Double



232341

Replacing 593751
Servicing A11Vi87
O.D. 63.7 mm, Bore 15 mm, W. 40.8 mm,
3 grooves



232352

Replacing 593762
Servicing A13Vi27, A14Vi27
O.D. 54.5 mm, Bore 17 mm, W. 27.8 mm,
6 grooves



232359

Replacing 592929
Servicing A11Vi108
O.D. 56 mm, Bore 17 mm, W. 30.8 mm,
5 grooves

Also see Pulley Survey page 609

Replacing VALEO / PARIS RHONE



233590
Replacing 593516, F-234637
Servicing SG12B050, 2542523
 O.D. 48.8 mm, Bore 17 mm, W. 36.9 mm,
 5 grooves, w/ Free wheel
Pulley tool: Cargo 210843



234097
Replacing 593760
Servicing A13Vi201
 O.D. 51.4 mm, Bore 17, W. 27.9 mm,
 6 grooves



234569
Replacing F-233593.1
 O.D. 56 mm, Bore 17 mm, W. 37.8 mm,
 6 grooves, w/ Free wheel
Pulley tool: Cargo 210843



233847
Replacing 593618, F-232030.12
Servicing SG15L012, -26
 O.D. 49.8 mm, Bore M16, W. 36.3 mm,
 5 grooves, w/ Free wheel
Pulley tool: Cargo 210909



234149
Replacing 593527, F-229603.7, -12
Servicing A14Vi41, -48, -49, SG15S018,
 -019, -022, -024, -025
 O.D. 54.4 mm, Bore 17 mm, W. 32.4 mm,
 6 grooves, w/ Free wheel
Pulley tool: Cargo 210843



234794
Replacing 593832, F-236591.1, -4
Servicing TG156028
 O.D. 54.2 mm, Bore 17 mm, W. 38 mm,
 6 grooves, w/ Free wheel
Pulley tool: Cargo 210843



233848
Replacing 593593
Servicing SG12B011, -025, -054,
 SG14B012, -013
 O.D. 64.3 mm, Bore 17 mm, W. 31.3 mm,
 6 grooves



234377
Replacing 593608
Servicing SG12B040
 O.D. 60 mm, Bore 17 mm, W. 36.4 mm,
 6 grooves

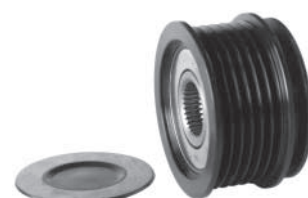

234795
Replacing 593778, F-231142.1
Servicing SG12B075, SG14B016
 O.D. 56 mm, Bore 17 mm, W. 35.3 mm,
 6 grooves, w/ Free wheel
Pulley tool: Cargo 210843



234039
Replacing 593735
Servicing A13Vi260, -261
 O.D. 62.7 mm, Bore 17, W. 30.8 mm,
 6 grooves



234540
Replacing 593619
Servicing A13Vi282, SG8B022,
 SG9B064, -067
 O.D. 48.5 mm, Bore 17 mm, W. 31.5 mm,
 6 grooves



234993
Replacing 593620
Servicing A14Vi42, SG15S016, -021,
 -031
 O.D. 54.3 mm, Bore 17 mm, W. 29.6 mm,
 6 grooves

Replacing VALEO / PARIS RHONE

Also see Pulley Survey page 809



234994

Replacing 593612
Servicing SG9B053, SG12B030, -072
 O.D. 49 mm, Bore 17 mm, W. 33 mm,
 6 grooves



236599

Replacing 593794
Servicing TG15C012
 O.D. 53.5 mm, Bore 17 mm, W. 35.8 mm,
 6 grooves



210843

Tool to be used for mounting and
 dismantling of free wheel pulleys
 Shaft L. 74 mm.

210948

As Cargo 210843, but
 Shaft L. 114 mm.



236995

Replacing 593860, F-237101.2
Servicing TG8S012, -013, TG9S010, -015
 O.D. 54 mm, Bore 17 mm, W. 37.5 mm,
 6 grooves, w/ Free wheel
Pulley tool: Cargo 210843



210909

Tool to be used for mounting and
 dismantling of free-wheel Valeo pulleys

235373

Replacing 593331
Servicing SG7S016, TG7S011
 O.D. 49 mm, Bore 17 mm, W. 29 mm,
 6 grooves



236115

Replacing 593777
Servicing SG9B026, SG9B057
 O.D. 49.4 mm, Bore 17 mm, W. 31.5 mm,
 6 grooves



237320

Replacing F-234739, 593494
Servicing SG12B047, SG14B010
 O.D. 56 mm, Bore 17 mm, W. 43.7 mm,
 6 grooves, w/ Free wheel
Pulley tool: Cargo 210843

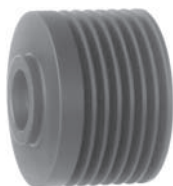

236137

Replacing 593668
Servicing E5435D-05, SG12B052
 O.D. 49.3 mm, Bore 17 mm, W. 35.5 mm,
 7 grooves

237500

Replacing 593539
Servicing SG11B010, SG12B065,
 SG14B017
 O.D. 49 mm, Bore 17 mm, W. 37.3 mm,
 6 grooves, w/ Free wheel
Pulley tool: Cargo 210843



Replacing VALEO / PARIS RHONE

Fan & Pulley Parts



231452

Replacing A13Vi202
O.D. 34 mm
Cover for free wheel pulley



235233

Replacing A12R30, -31, A13R231, -243, A13N85, -109, -173, -283, 56M, -283M, A14N4, -55, -88, -144, -118M, -119M, -141M, 200M, --206M
17.16 x 24 x / 27 x 4.78 mm
Spacer

Repair Kits



230423

Replacing 592854
Servicing A11Vi ..., A13Vi ...



230901

Replacing 593282
Servicing A14Vi ...



232045

Replacing 593283
Servicing A14Vi19, -20, HD90S010, -11, -013, -014, -015

Sundry Parts



131055 Std pkg 10 A

Replacing 072534
Servicing A12M5, -8
Fuse 35 Amp.



131583 Std pkg 10 A

Replacing 098882
Servicing A12M9, -11, -15, -16, -17
Fuse 30 Amp.



135169 Std pkg 10 A

Servicing A11Vi ..., A13Vi ...
Terminal cap
Alternators w/ internal fan



134797 Std pkg 10

Servicing A13N ...
Insulator for B+ bolt Cargo 134793

Replacing VALEO / PARIS RHONE



136586 Std pkg 5
Servicing A14V . . .
 Insulator for B+, D+



231844
Servicing A13N164
 I.D. 6.3 mm
 W Insulator



234884 
Servicing A13N1M, A13N147M,
 A13N148M, A13N149M, A13N259,
 A13N259M, A13N35M, A13N46, A14N67,
 A14N73, A14N75
 Insulator



136764 Std pkg 5
Servicing A14V13
 Insulator for B+, D+



233911
Servicing A14Vi23, -27, -29, -35, -41, -42
 O.D 7.3/16.2 mm, I.D. 5.2 mm, W. 7.4 mm
 Insulator



235293 
Servicing A13N28, -52, -281, A14N47M,
 -30M, -74, 100M, -102, -112M, -115M,
 -118M, -119M, -131, -141M, -151, -164,
 -176, -177M, -196M, -198M, -199, -200M,
 18 x 8.5 x 5.3 mm
 Insulator



139801 Std pkg 10
 6 x 15.1 x 6.1 mm
 B+ Insulator



234954 
Servicing A13E50
 Insulator



135429
Replacing 592850
Servicing A13Vi24, -67, -69, -70, -77
 D+ terminal



139802 Std pkg 10
 5 x 13.25 x 5.6 mm
 D+, W Insulator



235017 
Servicing TG..., SG...
 6 x 7.6-14.4 x 11.9 mm
 Insulator

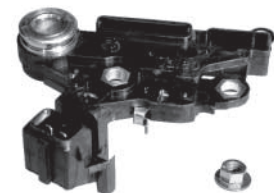

135431 
Replacing 592933
Servicing A11Vi221, -22
 B+, W terminal

Replacing VALEO / PARIS RHONE



135433

Replacing 592852
Servicing A11Vi28, -31, A13Vi11, -13, -14, -16, -17, -21, -23, -25, -28, -30, -32
 D+ terminal



136661

Replacing 592849
Servicing A13Vi10, -18, -76
 D+ terminal



232212

Replacing 593377
Servicing A11Vi99, -101, -102, A13Vi236, -242, -246, -256
 D+ terminal



135495

Replacing 592851
Servicing A11Vi10, -11, -23, -24, -25, A13Vi46, -49
 Terminal



137522

Replacing 593233
Servicing A13Vi74, -75, -99, -100
 D+ Terminal



232213

Replacing 593251
Servicing A14Vi19, -20, HD90S010, -011
 D+ terminal



135514

Replacing 592853, 593360
Servicing A11Vi16, -17, -18, -91
 A13Vi31, -48
 B+, D+ terminal



139451

Replacing 593288
Servicing A14Vi15, -16, -17, -27, -35
 B+, D+ terminal



232215

Replacing 593421
Servicing A13Vi276
 D+ terminal



136644

Replacing 592934
Servicing A13Vi54
 D+ terminal

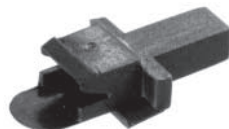

231381

Servicing A13Vi236
 Insulator
Part of Repair kit: Cargo 230423



135469 Std pkg 10

Servicing A11Vi, A13Vi
 18 x 28 x 4 mm
 Rubber seal

Replacing VALEO / PARIS RHONE

Also see O-ring Survey page 854



135470 Std pkg 10
Servicing A11Vi, A13Vi
 18 x 30 x 4 mm
 Rubber seal



234941 
Servicing TG11C010, -11, -15, -16, -22
 O.D. 129 mm
 O-ring



233791 Std pkg 25
Servicing A14Vi23, -27, -29, -35, -41, -42
 M5 x 84 mm
 Screw



234965 
Servicing TG8C011, TG9C013,
 TG11C010, -11, -15, -16, -22, TG14C011,
 TG15C012, -15, -20, -23, -28
 L. 42 mm, W. 5 mm, H. 3.2 mm
 Rubber spacer



232310
Servicing A14Vi19, -20
 Connector Arm D+



234035
Servicing A14Vi23, -27, -29, -35, -41, -42
 M5 x 47.5 mm
 KNURL O.D. 5.5 mm
 Screw



137730 Std pkg 10
 13 x 3 mm
 O-ring



234044
Servicing A14Vi35, -40
 M5 x 34.3 mm,
 Terminal bolt B+



234615 
Servicing A13N1M, -2M, -35M, -56M,
 -147M, -148M, -149M, -259M, -283,
 -283M, A13R203, -221, -222, A14N30M,
 -47M, -81M, -100, -112M, -115M, -118M
 M5 x 57.8 mm, threaded 55.5 mm
 Screw



138193 Std pkg 10
Servicing A9R...
 71 x 3 mm
 O-ring



235165 
Servicing A11Vi...
 M8 x 39 mm
 Terminal bolt B+



234616 
Servicing A13N1M, -2M, -35M, -147M,
 -148M, -149M, -259, -259M, A14N30M,
 -47M, -67, -73, -75, -81M, -100, -112M,
 -115M, -118M, -119M, -141M, -177M
 M6 x 59.9 mm, threaded 52.6 mm
 Screw

Replacing VALEO / PARIS RHONE



234617

Servicing A13N1M, -2M, -56M, -147M, -148M, -149M, -259, -259M, -283, -283M, A14N30M, -47M, -81M, -100, -112M, -115M, -118M, -119M, -141M, -177M
M5 x 57.4 mm, threaded 22.3 mm
Screw



234018 Std pkg 5

Servicing A11Vi..., A13Vi..., A14Vi..., SG8B..., SG10B..., SG12B..., SG15S...
Key



234011 Std pkg 10

Servicing A14N...
M5 x 115 mm,
KNUURL O.D. 5.7 mm
Thru bolt



236104

Servicing TG8C011, -012, TG9C013
121 x 1.54/3.10 mm
Gasket



234014 Std pkg 10

M5 x 96 mm,
KNUURL O.D. 5.5 mm
Thru bolt



236756

Servicing TG14C011, TG15C012, -015, -020, -023, -028
134 x 1.50/2.70 mm
Gasket



234015 Std pkg 10

M5 x 80 mm,
KNUURL O.D. 5.7 mm
Thru bolt

Replacing VALEO / PARIS RHONE

Generator Bushings



140068 Std pkg 10

Replacing 047403
17.05 x 21.05 x 20 mm

Replacing WAPSA

Regulators



131297

Replacing RWA-T-2, 00-408-32
Servicing Ford
12 V.

Slip Rings



130841 Std pkg 10
O.D. 36 mm, Shaft 17 mm, L. 22.5 mm

Replacing TRUCKS / COACHES

Also see Pulley Survey
page 809



Cargo
110541 - 110543 - 110544

Rotors



134471
Servicing VG-986, -921, Ikarus
Cargo 110541, 110543, 110544
24 V.
L. 258.3 mm, O.D. 126 mm, Shaft 30 mm

Stators



134472
Servicing VG-921, Ikarus
Cargo 110544
24 V. 124 Amp



135227
Servicing VG-986, -986-1
Cargo 110541, 110543
24 V. 125 Amp.

Regulators



134079
Replacing KF-900
Servicing VG-986-24V, VG-921-24V,
Ikarus, Cargo 110541, 110543, 110544
24 V.

Rectifiers



134473
Servicing VG-986, -921, Ikarus
Cargo 110541, 110543, 110544

Brush Boxes



134474
Servicing VG-986, -921, Ikarus
Cargo 110541, 110543, 110544
W/ brushes

Brush Sets



140652
Replacing SK56-57/Z
Servicing VG-986, -921, Ikarus
Cargo 110541, 110543, 110544
6 x 10 x 16 mm
24 V.

Fan & Pulleys



133509
Servicing VG-986, -921, Ikarus
Cargo 110541, 110543, 110544
O.D. 210 mm, Bore 30 mm
Fan



133508
Servicing VG-986, -921, Ikarus
Cargo 110541, 110543, 110544
O.D. 105 mm, Bore 30 mm
Double, B-type belt

MISCELLANEOUS

Regulators/Rectifiers

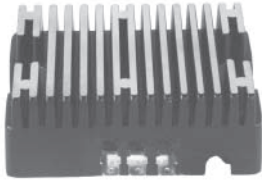

138895

Replacing 4720
Servicing John Deere w/ Kohler eng./small eng.
 14.5 V. For permanent magnet system,
 20 Amp. max.
 Terminals: STA- B+ -STA

Volt setting 14.4 V.



230150

Replacing 237335
Servicing Kohler 10-18 HP Eng.
 W/ 15 Amp. charging systems
 12 V.
 Terminals: B+ - AC - AC

Volt setting 14.2 V.

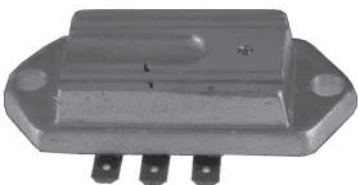

230151

Replacing 25-755-03
Servicing Kohler
 12 V.
 Terminals: AC - B+ - AC



230152

Replacing 191-1748, -2106
Servicing Onan
 16-20 HP Engines
 12 V.

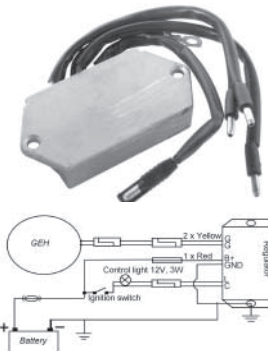

231211

Replacing 343680, 434368001
Servicing Ducati Monster 916,
 Moto Guzzi, Laverda
 12 V. 40 Amp.
 Terminals: G - G - GND - B+ - L - C

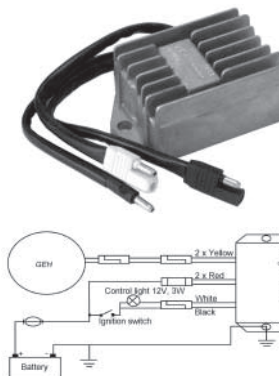

231212

Replacing 343638, 434363800
Servicing Hatz
 12 V. 25 Amp.
 Terminals: G - G - B+ - L - C

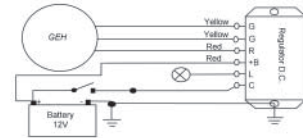
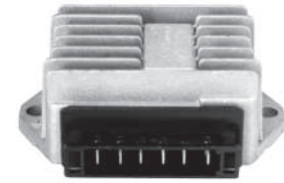

231469

Replacing 343520, 434352000
Servicing Ducati
 12 V. 22 Amp.
 Terminals: G - G - R - B+ - L - C
 Connector: Cargo 231450

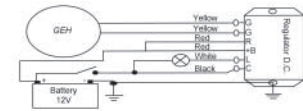

231470

Replacing 343620, 434362000
Servicing Ducati
 12 V. 22 Amp.
 Terminals: G - G - R - B+ - L - C
 Connector: Cargo 231450

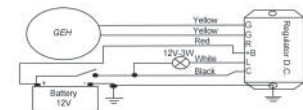

231570

Replacing 343621, 434362100, 434862100
Servicing Ducati, Piaggio
 12 V. 28 Amp.
 Terminals: G - G - B+ - L - C

MISCELLANEOUS



231902

Replacing 343530, 343535, 434353000
Servicing Ducati, Lombardini
 12 V. 22 Amp.
 Terminals: G - G - R - B+ - L - C

Volt setting 14.4 V.



233976

Replacing 883071
Servicing Mercury marine
 12 V. 5-wire
 Terminals: Tach.(grey), AC(yellow), B+(red), B-(black), AC(yellow)

Volt setting 14.4 V.



233977

Replacing 815279T, 830179T, 854515
Servicing Mercury marine
 12 V. 6-wire
 Terminals: Tach.(grey), AC(yellow), Sense (red female), B+ (red male), B- (black), AC(yellow)

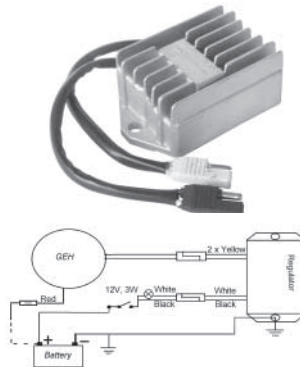

233992

Replacing 343526, 434352600 (Ducati)
Servicing Hatz
 12 V. 25 Amp.
 Terminals: G - G - L - C

Volt setting 14.4 V.



234090

Replacing 74505-97
Servicing Harley Davidson
 Ceramic hybrid construction, chrome
 12 V.

Volt setting 14.4 V.

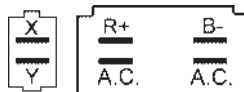

234250

Replacing 21066-2071, SH637-12
Servicing Kawasaki powered commercial mowers w/ rope-start and electric clutch
 12 V. Shunt type
 Capacitor: X: Orange, Y: Black

234251

Replacing M131287, 12-403-01
Servicing Kohler powered commercial mowers w/ rope-start and electric clutch
 12 V.
 Terminals: AC - B+

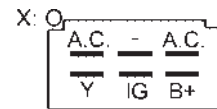
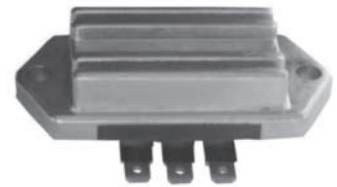

234303

Replacing RS5121
Servicing Compact tractors and industrial equipment w/ permanent magnet alternators
 X: Negative when charging
 Y: Positive when charging

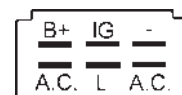

234407

Replacing 21066-2070
Servicing Kawasaki 20, 22 HP water cooled V-twins, John Deere models 425, 445, F911
 12 V.
 20 Amp. charging systems

MISCELLANEOUS



234408

Replacing AM101406
Servicing John Deere models 322, 330, 332, 670, 770, 870, 970, 1070, F915
 12 V.
 Terminals: B+, AC, AC, L, IG



234411

Replacing 15531-64601, RS5101, -5155
Servicing Kubota Grasshopper model 1822D, 718D, 721D, 721G
 12 V.
 Terminals A.C.(Blue), B-(Black), A.C.(Blue), L(Green), IG(Yellow), B+(Red)

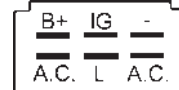

234414

Replacing AM126304
Servicing John Deere
 12 V.
 Terminals
 B+(Red), IG(Red w/blue), - (Black), A.C.(Yellow), L(Brown), A.C.(Yellow)



234409

Replacing 66611-55250, 67211-55230
Servicing Kubota compact tractors w/ permanent magnet alternator w/o „no charge“ indicator light
 12 V.
 Terminals -(Black), B+(Red), AC(Blue), AC(Blue)

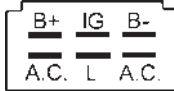

234412

Replacing M97348, RS5160
Servicing John Deere Gator 4x2 + 4x6 2243 diesel golf equipment, 3375 Skid Steer, 595 Garden tractor
 12 V. 20 Amp. charging systems
 Terminals B+(Red), IG(Yellow), B-(Black), A.C.(Orange), L(Brown), A.C.(Orange)

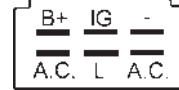

234417

Replacing 316 00 890 951
Servicing Honda Lawn tractor
 12 V.

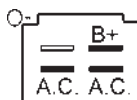
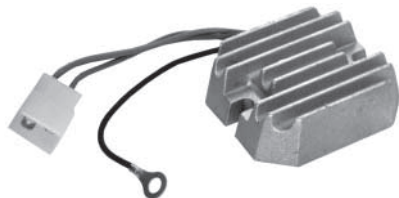

234410

Replacing RS5107
Servicing Massey Ferguson model 205-4
 12 V.

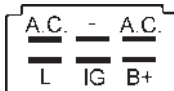

234413

Replacing M802471, RS5102, -5104
Servicing John Deere compact tractor model 650, 750
 12 V.
 Terminals A.C.(Blue), - (Black), A.C.(Blue), L(Green), IG(Yellow), B+(Red)

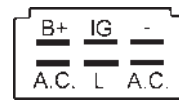

234418

Replacing 21066-2056, M70121
Servicing Kawasaki, John Deere
 12 V.
 13, 15, 17 Amp. charging system

MISCELLANEOUS

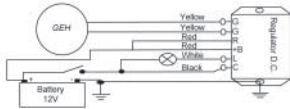

234853

Replacing 343631, 434363100
Servicing Ducati
 12 V. 22 Amp.
 Terminals: G - G - R - B+ - L - C

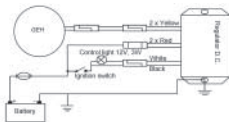

234854

Replacing 343626, 434362600
Servicing Ducati
 12 V. 25 Amp.
 W/ recharge indication
 Terminals: G - G - B+ - L - C

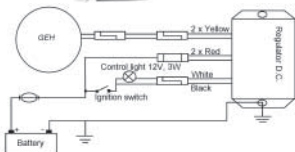

234855

Replacing 343644, 434364400
Servicing Ducati
 24 V. XX Amp.
 Terminals: G - G - B+ - L - C



234986

„No charge“ indicator light „Gizmo“ adapts alternators that do not have any method of operating a „no charge“ indicator light to be used on a vehicle w/ a „no charge“ indicator light.



Allows alternators such as Leece Neville, Motorola and others w/o „no charge“ indicator light to replace alternators such as Delco 21SI w/ indicator lights.

Add a „no charge“ indicator light to vehicles not now equipped.

Can be used on 12 or 24 V. alternators.

Easy to install.

Connect Black wire to alternator (-),

Yellow wire to stator terminals / W.

Orange wire to „no charge“ indicator light.

Secure Cargo 234986 to alternator output wire w/ wire tie.

Regulator/Rectifier Parts



231450

Servicing Cargo 231469, 231470
 Connector

Also see Pulley Survey
page 809

MISCELLANEOUS

Regulators

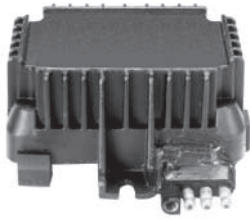

231464

Replacing A2-102
Servicing Niehoff A1-102, -104, -106
12 V.

Volt setting 27.5 V.



234325

As Cargo 234324 but 24 V.
Adjustable Voltage

Rectifiers



135630

Replacing 580841, 582307, 582399
OMC outboards
25 Amp. Diodes

Volt setting 14.2 V.



234324

Servicing EMV, Limo, Marine, Police Car,
RV, Taxi....
12 V. Voyager
Regulation: **B-Circuit**
Adjustable Voltage (13-16 V.)
Voyager series regulator,
Over voltage protection,
Precise digital regulation,
Short circuit protected,
High current capability,
Ignition or light circuit activated with high
side regulation.
Protected against loss of ground and under
voltage.
LED's for easy troubleshooting
Fault detection indicators



135631

Replacing 581771
OMC outboards
25 Amp. Diodes



135632

Replacing 62351A1, -A2
Mercury outboards
25 Amp. Diodes

MISCELLANEOUS

Also see Pulley Survey
page 809

Fan & Pulleys



231465

Replacing A3-300
Servicing Niehoff A1-104
Fan: O.D. 140 mm
Pulley: O.D. 70 mm, I.D. 17 mm, W. 32 mm



232149

O.D. 62.6 mm, Bore 17 mm, W. 26.3 mm,
Single, 16-19 mm belt



232150

Replacing 70250599
Servicing Allis-Chalmers
O.D. 75.3 mm, Bore 17 mm, W. 32.9 mm,
Single, B-type belt



232151

Replacing L59716
Servicing Case
O.D. 78.4 mm, Bore 17 mm, W. 47.7 mm,
Double, 16 mm belt



232152

Replacing K187367
Servicing Kenworth
O.D. 72.6 mm, Bore 22.23 mm (7/8"),
W. 44.6 mm, 8 grooves



232153

Replacing 3014711
Servicing Cummins
O.D. 77.6 mm, Bore 22.23 mm (7/8"),
WW. 66.2 mm, 9 grooves

Fan & Pulley Parts



231666

27 x 42 x 2.3 mm
Washer for free wheel pulley

Sundry Parts



138422 Std pkg 5

Inside M10-1.0
Outside M10-1.5
Adaptor

DYNASTARTER components

Armatures



130338

Replacing 06195, 2014 003 902
Servicing Efel 6000, -6030, -6770,
 Cargo 110060, 110061, 110064
 12 V. 11 Amp. 0.9 kW.
 L. 230.6 mm, O.D. 60.1 mm

Regulators



130008

Replacing 0190 350 063, 10480
Servicing 10880
 12 V. 38 Amp. 220 Watt



233623

Replacing 1118981, -988
 12 V.

Field Coils



130341

Replacing 06762
Servicing Efel 06000, -06030, -06850,
 Cargo 110060, 110061, 111504
 12 V. 11 Amp. 0.9 kW.



130047

Replacing 0190 215 028, 36473
 12 V. 11 Amp. 90 Watt



233624

Replacing 1118381, -779, -997, -999
 12 V.



233622

Replacing 1118266, -306, -791, -983, -985
 12 V.



233625

Servicing Golf carts
 12 V.
 Terminals: D+, DF, D-

DYNASTARTER components

Also see Bearing Chapter page 821

Solenoids

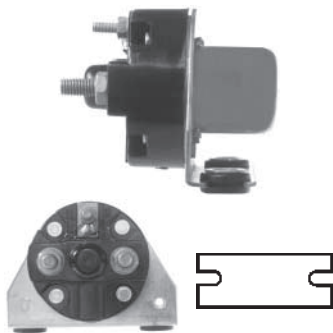

130336

Replacing 06020, 0332 002 102
Servicing Cargo 110060, 110061, 110064
 12 V.
 100 Amp. 60 sec.
 M6 studs.

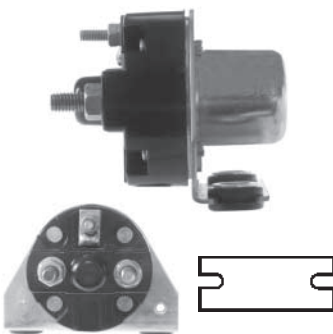

130993

Replacing 10485
Servicing 10880
 12 V.
 100 Amp. 150 sec.
 M6 brass studs.

Brush Sets



130988

Replacing 21391
Servicing Cargo 110059
 12 V. 8 x 14 x 25 mm



BX188 4 Std pkg 10

Replacing 2017 014 104, -105
Servicing 0010 300 . . . , 0010 350 . . .
 Cargo 110060, 110061, 110064
 12 V. 6 x 14 x 23.5 mm



NOX29 2P Std pkg 10

Replacing 1027 014 106
Servicing NSU Dynastarter
 12 V. 5.8 x 10 x 22 mm

Special Bearings



140086 Std pkg 10

Replacing 85218, 6202 ZZ
Servicing Cargo 110059
 15/35 x 10 mm
 C.E.



140088 Std pkg 10

Replacing 85219, 6203 ZZ
Servicing Cargo 110059
 17/40 x 12 mm
 D.E.

Rotor Parts



132324 Std pkg 10 A

Replacing 04009
 4 x 6.5 x 16 mm
 Key

UNIVERSAL components

Diodes



130669 Std pkg 10 **A**
 25 Amp. 200 V.
 ½" (12.7 mm) press fit
 27 mm lead
 Positive



130911 Std pkg 10 **A**
Replacing 0270 100 406
 35 Amp. 200 V.
 ½" (12.7 mm) press fit
 20 mm lead
 Negative



131293 Std pkg 10 **A**
Replacing 83 576
 25 Amp. 400 V.
 10 mm press fit
 20 mm lead
 Positive



130670 Std pkg 10 **A**
 25 Amp. 200 V.
 ½" (12.7 mm) press fit
 27 mm lead
 Negative



130912 Std pkg 10 **A**
Replacing 0270 100 405
 35 Amp. 200 V.
 ½" (12.7 mm) press fit
 20 mm lead
 Positive



131294 Std pkg 10 **A**
Servicing Paris Rhone, SEV Marchal
 3 Amp. 1000 V.



130671 Std pkg 10 **A**
 35 Amp. 100 V.
 ½" (12.7 mm) press fit
 55 mm flexible lead
 Negative



130937 Std pkg 10 **A**
Replacing 0270 000 009, Si Diode
Servicing 1121 099 007, Cargo 131095
 SEV Marchal 712 09803, 712 13003
 Paris Rhone, Motorola
 1 Amp. 1000 V.



131506 Std pkg 5 **A**
 25 Amp. 100 V.
 0.34" (8.7 mm) Tin can
 18 mm lead
 Negative



130672 Std pkg 10 **A**
 25 Amp. 100 V.
 ½" (12.7 mm) press fit
 25 mm flexible lead and 4 mm terminals
 Positive



131292 Std pkg 10 **A**
Replacing 83 577
 25 Amp. 400 V.
 10 mm press fit,
 20 mm lead
 Negative



131507 Std pkg 5 **A**
 25 Amp. 100 V.
 0.34" (8.7 mm) Tin can
 18 mm lead
 Positive

UNIVERSAL components



131508 Std pkg 5 **A**
 20 Amp. 300 V.
 0.33" (8.4 mm) dish
 1.5 x 20 mm lead
 Negative



131512 Std pkg 5 **A**
 35 Amp. 200 V.
 0.4" (10 mm) button
 Positive or negative
 Cathode = white ring



133194 Std pkg 10 **A**
 35 Amp. 100 V.
 1/2" (12.7 mm) press fit
 Flexible lead
 Negative



131509 Std pkg 5 **A**
 20 Amp. 300 V.
 0.33" (8.4 mm) dish
 1.5 x 20 mm lead
 Positive



131513 Std pkg 5 **A**
 25 Amp. 100 V.
 0.4" (10 mm) button
 24 mm lead
 Negative



133495 **A**
 70 Amp. 400 V.
 Maximum reverse current 1 milliamp.
 1/4 - 28 stud.
 Positive



131510 Std pkg 5 **A**
 30 Amp. 300 V.
 0.38" (9.7 mm) dish
 1.5 x 20 mm lead
 Negative



131514 Std pkg 5 **A**
 25 Amp. 100 V.
 0.4" (10 mm) button
 24 mm lead
 Positive



133496 **A**
 70 Amp. 400 V.
 Maximum reverse current 1 milliamp.
 1/4 - 28 stud.
 Negative



131511 Std pkg 5 **A**
 30 Amp. 300 V.
 0.38" (9.7 mm) dish
 1.5 x 20 mm lead
 Positive



133193 Std pkg 10 **A**
 35 Amp. 100 V.
 1/2" (12.7 mm) press fit
 Flexible lead
 Positive



133704 Std pkg 5 **A**
 30 Amp. 200 V.
 Positive thin square diode
 Low profile block type diode

UNIVERSAL components



133705 Std pkg 5 **A**
 30 Amp. 200 V.
 Negative thin square diode
 Low profile block type diode



135152 Std pkg 10 **A**
 35 Amp. 400 V.
 5/16", Tin can, w/ Fork lead, L. 26 mm
 Positive



136254 Std pkg 10
 40 Amp. 400 V.
 11.5 mm press fit
 20 mm lead
 Late model HITACHI internal fan alternator
 Negative



134519 Std pkg 10 **A**
 6 Amp. 400 V.



135153 Std pkg 10 **A**
 35 Amp. 400 V.
 5/16", Tin can, w/ Fork lead,
 26 mm lead
 Negative



137201 Std pkg 10
Replacing 102-42
 50 Amp. 200 V.
 1/2" (12.7 mm) press fit
 Positive



134494 Std pkg 10
Replacing Q05B-00, 23231-65002
 25 Amp. 200 V.
 1/2" (12.7 mm) press fit
 Negative



135213 Std pkg 25 **A**
Servicing Hitachi, Lucas, Mitsubishi,
 Motorola, Sev Marchal
 2 Amp. 200 V.



137202 Std pkg 10
Replacing 102-43
 50 Amp. 200 V.
 1/2" (12.7 mm) press fit
 Negative



134495 Std pkg 10
Replacing Q06B-00, 23232-65002
 25 Amp. 200 V.
 1/2" (12.7 mm) press fit
 Positive



136253 Std pkg 10
 40 Amp. 400 V.
 11.5 mm press fit
 20 mm lead
 Late model HITACHI internal fan alternator
 Positive



138634 Std pkg 10
 50 Amp. 200 V.
 1/2" (12.7 mm) press fit, Bosch type
 Positive

UNIVERSAL components



138635 Std pkg 10
50 Amp. 200 V.
½" (12.7 mm) press fit, Bosch type
Negative



138636 Std pkg 10
Servicing 24-32 V.
Hitachi type
50 Amp. Avalanche
11.5 mm press fit
20 mm lead
Positive



138637 Std pkg 10
Servicing 24-32 V.
Hitachi type
50 Amp. Avalanche
11.5 mm press fit
20 mm lead
Negative



231034 Std pkg 10
50 Amp. Avalanche
½" (12.7 mm) press fit
24 - 32 V.
Negative



231035 Std pkg 10
50 Amp. Avalanche
½" (12.7 mm) press fit
24 - 32 V.
Positive



231403 Std pkg 10
35 Amp. Avalanche
½" (12.7 mm) press fit
20 - 26 V.
Positive



231404 Std pkg 10
35 Amp. Avalanche
½" (12.7 mm) press fit
20 - 26 V.
Negative



231405 Std pkg 10
50 Amp. Avalanche
½" (12.7 mm) press fit
20 - 26 V.
Positive



231406 Std pkg 10
50 Amp. Avalanche
½" (12.7 mm) press fit
20 - 26 V.
Negative



231407 Std pkg 10
70 Amp. Avalanche
½" (12.7 mm) press fit
20 - 26 V.
Positive



231408 Std pkg 10
70 Amp. Avalanche
½" (12.7 mm) press fit
20 - 26 V.
Negative



231409 Std pkg 10
70 Amp. Avalanche
½" (12.7 mm) press fit
24 - 32 V.
Positive

UNIVERSAL components



231410 Std pkg 10
70 Amp. Avalanche
1/2" (12.7 mm) press fit
24 - 32 V.
Negative



231577 Std pkg 5
35 Amp. 200 V.
Negative thin square diode



233345 Std pkg 10
25 Amp. 100 V.
1/2" (12.7 mm) press fit
Chrysler hook lead
Positive



231411 Std pkg 10
35 Amp. Avalanche
1/2" (12.7 mm) press fit
24 - 32 V.
Positive



231578 Std pkg 5
40 Amp. 200 V.
Positive thin square diode



233346 Std pkg 10
25 Amp. 100 V.
1/2" (12.7 mm) press fit
Chrysler hook lead
Negative



231412 Std pkg 10
35 Amp. Avalanche
1/2" (12.7 mm) press fit
24 - 32 V.
Negative



231579 Std pkg 5
40 Amp. 200 V.
Negative thin square diode



233347 Std pkg 10
35 Amp. 100 V.
1/2" (12.7 mm) press fit
Chrysler hook lead
Positive



231576 Std pkg 5
35 Amp. 200 V.
Positive thin square diode



231670 Std pkg 10
2.5 Amp. 200 V.



233348 Std pkg 10
35 Amp. 100 V.
1/2" (12.7 mm) press fit
Chrysler hook lead
Negative

UNIVERSAL components



233349 Std pkg 10
 35 Amp. 200 V.
 1/2" (12.7 mm) press fit
 Insulated lead w/ flag terminal
 Positive



233353 Std pkg 10
 25 Amp. 24-32 V. Avalanche
 8.5 mm button
 Positive or negative



233357
 35 Amp. 200 V.
 10 mm press fit
 Negative



233350 Std pkg 10
 35 Amp. 200 V.
 1/2" (12.7 mm) press fit
 Insulated lead w/ flag terminal
 Negative



233354 Std pkg 10
 35 Amp. 24-32 V. Avalanche
 8.5 mm button
 Positive or negative



233358 Std pkg 10
 50 Amp. 200 V.
 10 mm button
 Positive or negative



233351 Std pkg 10
 25 Amp. 200 V.
 8.5 mm button
 Positive or negative



233355 Std pkg 10
 35 Amp. 100 V.
 1/2" (12.7 mm) press fit
 Positive



233359 Std pkg 10
 25 Amp. 200 V.
 10 mm button
 Positive or negative



233352 Std pkg 10
 50 Amp. 200 V.
 8.5 mm button
 Positive or negative



233356
 35 Amp. 200 V.
 10 mm press fit
 Positive



233360 Std pkg 10
 25 Amp. 200 V.
 8.5 mm button w/lead
 Positive

UNIVERSAL components



233361 Std pkg 10
25 Amp. 200 V.
8.5 mm button w/lead
Negative



233365 Std pkg 10
50 Amp. 200 V.
10 mm button w/lead
Negative



233369 Std pkg 10
50 Amp. 200 V.
9.7 mm dish
Negative



233362 Std pkg 10
50 Amp. 200 V.
8.5 mm button w/lead
Positive



233366 Std pkg 10
50 Amp. 200 V.
8.4 mm dish
Positive



233442 Std pkg 10
35 Amp. 24-32 V. Avalanche
10 mm (0.4") button
Positive or negative



233363 Std pkg 10
50 Amp. 200 V.
8.5 mm button w/lead
Negative



233367 Std pkg 10
50 Amp. 200 V.
8.4 mm dish
Negative



233443 Std pkg 10
35 Amp. 200 V.
1.5 x 19 mm lead
11.5 mm press fit
Positive



233364 Std pkg 10
50 Amp. 200 V.
10 mm button w/lead
Positive



233368 Std pkg 10
50 Amp. 200 V.
9.7 mm dish
Positive



233444 Std pkg 10
35 Amp. 200 V.
1.5 x 19 mm lead
11.5 mm press fit
Negative

UNIVERSAL components



233445 Std pkg 10
50 Amp. 100 V.
1.5 x 19 mm lead
11.5 mm press fit
Positive



233446 Std pkg 10
50 Amp. 100 V.
1.5 x 19 mm lead
11.5 mm press fit
Negative



233543
25 Amp. 100 V.
25 mm flexible lead and 4 mm terminals
1/2" (12.7 mm) press fit
Negative



233544
25 Amp. 100 V.
25 mm flexible lead and 4 mm terminals
1/2" (12.7 mm) press fit
Positive



234350 Std pkg 10
50 Amp. Avalanche
12.8 mm press fit
32-40 V.
Negative



234351 Std pkg 10
50 Amp. Avalanche
12.8 mm press fit
32-40 V.
Positive



234736
70 Amp. Avalanche
12.8 mm press fit
32-40 V.
Positive



234737
70 Amp. Avalanche
12.8 mm press fit
32-40 V.
Negative



234738
70 Amp. Avalanche
12.8 mm press fit
19-24 V.
Positive



234739
70 Amp. Avalanche
12.8 mm press fit
19-24 V.
Negative



235007 Std pkg 10 
35 Amp.
1/2" (12.7 mm) press fit
100 V.
Negative



235276 
50 Amp. 200 V.
10 mm press fit,
21 mm lead
Positive

UNIVERSAL components



235277

50 Amp. 200 V.
10 mm press fit,
21 mm lead
Negative



235349 Std pkg 10

35 Amp.
1/2" press fit
200 V.
Positive



236253 Std pkg 10

Replacing 0270 300 114
65 Amp. Avalanche
13 mm press fit
19-25 V.
Negative



235346 Std pkg 10

25 Amp.
1/2" press fit
200 V.
Negative



235350 Std pkg 10

50 Amp.
1/2" press fit
200 V.
Negative



236888

50 Amp. Avalanche
24-32 V.
Positive



235347 Std pkg 10

25 Amp.
1/2" press fit
200 V.
Positive



235351 Std pkg 10

50 Amp.
1/2" press fit
200 V.
Positive



236889

50 Amp. Avalanche
24-32 V.
Negative



235348 Std pkg 10

35 Amp.
1/2" press fit
200 V.
Negative



236252 Std pkg 10

Replacing 0270 300 113
65 Amp. Avalanche
13 mm press fit
19-25 V.
Positive



UNIVERSAL components

Sundry Parts



191801 Std pkg 100
Pin terminal for 1 wire stator lead



191805 Std pkg 100
Stator wire repair tube
Eyelet



191855 Std pkg 100
Pin terminal for 3 wire stator lead



192584 Std pkg 100
Pin terminal for 1 wire stator lead



232726 Std pkg 10
Repair lead for 1/2" press fit diodes

UNIVERSAL components

Various



132581 Std pkg 10 **A**
5.0 x 7.3 - 14.3 x 4 mm
Insulator bushing



132582 Std pkg 10 **A**
6.35 x 14.73/15.08 x 6 mm
Insulator bushing



134686
Dielectric Gel
Prevents fusing of spark wires to spark plugs, boot tears, corrosion and arcing. Odorless, non-volatile. Works in extreme temperatures. Resists moisture, air, acids and alkalines. Moisture proof seal for automotive marine and other ignition and electrical systems. For distributor caps, battery cables, battery posts and terminals, light bulb sockets, trailer hitch electrical connectors and all other types of electrical connections. Prevents corrosion and related problems.
5 oz, 142 g



232776 Std pkg 5
As Cargo 134686, but
2 g.



Heat transfer grease is a grease-like silicone material heavily filled with heat conductive metal oxides. This material maintains a positive heat sink seal that improves heat transfer from electrical and electronic devices to the heat sink or chassis.
Used where heat dissipation is required.

200618
5 oz, 142 g



132986 Std pkg 10
Stator extension wire.
Installation tips for stator extension wire assembly:
- Cut stator lead 1" long from stator iron.
- Scrape varnish so stator lead is clean for soldering.
- Position stator lead through hole in extension wire.
- Crimp stator lead to extension wire and solder.
- Slip insulation sleeving over solder joint.



134654
15 mm bore, 10 mm thick
Rotor wire separator

Terminal Chart

	Feld/Läufer, Feil/Rotor, Inductor/Rotor, Inducteur/Rotor, Field/Rotor, Campo/Rotor, Veld/Rotor, Fält/Rotor	Masse, Stel, Massa, Chassis, Ground, Massa, Massa, Jord	Kontrolllampe, Kontrolllampe, Lámpara de control, Lampe de contrôle, Charging Lamp, Lampada di controllo, Controllelampe Laddlampe	Zündung, Tænding, Ignición, Allumage, Ignition, Accensione, Ontsteking, Tändning	Mittelpunkt, Midtpunkt, Punto central, Point Central, Neutral/Wye, Punto centrale, Neutral, Mittelpunkt	Drehzahlmesser, Omdrejningsstæller, Contador de revoluciones, Compte tours, Tacho, Contagiri, Toerenteller, Varvråknare	Computer Anschluß, Computer control, Control CPU, Borne d'ordinateur, CPU Control, Terminale di computer, Computeraansluiting, Data-ansluiting	Bat-sensing, Batteri føler, Sensor de batería, Sens de batterie, Battery Sense, Senso di batteria, Accusensor, Batteri-sensor	Batterie, Batteri +, Bateria, Batterie, Battery, Battaria +, Accu +, Batteri +	Dummy, Dummy, Borne sin función, Borne sans fonction, Dummy, Attacco vuoto, Dummy, "Dummy"
BOSCH	DF	D-	D+/61/L	15		W	DFM/FR	S	B+	
BUTEC	F	-	D+						B+	
DELCO	F	GRD	D+/L/1	I/IG		P/R/W		M/S/2	B+	
DUCELLIER	EXC	-/B-	D+			W			B+	
ELMOT	67	31	15			W			B+	
FORD (VISTEON)	DF/F/FLD	D-/VE	D+/IND/I			W/STA/S			B+/Bat	
HITACHI	F	E	L	IG/R	N	P	FR/G	S	B/A	D
ISKRA	DF	D-	D+			W			B+	
LADA	67	31	15						B+/30	
LUCAS	F	-	D+			STA		S	B+	
PAL/MAGNETON	M	-	R						B+	
MANDO	F	E	L/I	IG/R	N	P		S	B/A	D
MARELLI	67	31	15		C	W	FR/SIG		B+/30	
MITSUBISHI	F	E	L	IG/R	N	P	FR/G/D	S	B/A	D
MOTOROLA	EXC	-/B-	D+			W			B+	
NIPPONDENSO	F	E-	L	IG/R	N	P	FR/C/M	S	B/A	D
PARIS RHONE	EXC	-/B-	L			W			B+	
SEV MARCHAL	DF	-/B-	61+			W			B+	
VALEO	EXC	-	L/D+	+		W			B+	

ALTERNATOR COMPONENTS





ASSORTMENTS

PART 2
16th Edition



Contents

	Page
802017 Alternator Mounting Parts	Bosch 796
802019 Alternator Parts	Bosch 796
802001 Alternator Parts	Delco Eur. 796
802020 Alternator Parts	Delco US 797
802021 Alternator Parts - CS 121, 130, 144	Delco US 797
802015 Alternator Parts	Lada / Magneti Marelli 797
802016 Alternator Parts	Lucas 798
802008 Alternator Parts	Mitsubishi 798
802013 Alternator Parts	Motorola 798
802004 Alternator Parts	Nippondenso 799
802003 Alternator Parts, IF	Nippondenso 799
802014 Alternator Parts	Paris Rhone / Valeo 799
802022 Alternator Parts	SEV 800
802034 Bearing Caps - Alternators	Various 802
802010 Bearing Tolerance Rings - Alternators	Various 803
802031 Brushes	Various 801
802027 Brushes - Japanese Alternators	Various 801
802011 Diodes - Alternators	Various 800
802033 Free Wheel Pulleys	Bosch 796
802024 IC Regulator	Hitachi / Mitsubishi / Nippondenso 800
802035 Needle Bearings	Various 802
802028 Nuts & Keys - Alternators	Various 803
802029 Oil seals for alternators	Various 802
802032 Slip Rings	Various 800
802026 Small Bearings - Alternators	Various 802
802023 Spacers for pulleys - Alternators	Various 803
802025 Special Bearings - European Alternators	Various 801
802002 Special Bearings - Japanese Alternators	Various 801
802007 Vacuum Pump Parts	Hitachi 797
802009 Vacuum Pump Parts	Mitsubishi 798
802005 Vacuum Pump Parts	Nippondenso 799
Index for Assortments	804

Assortment Box and Inserts

200663 Std pkg 6
 Profi Service Case, empty.
 Can be divided using inserts.
 Dim.: 340 x 265 x 57 mm.
 Polypropylene (Unbreakable).

**INSERTS FOR
 ASSORTMENT BOXES
 Polypropylene
 (Unbreakable)**

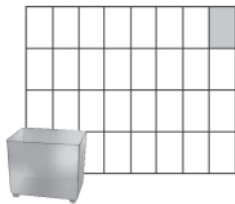

200664 Std pkg 96
 Dim.: 55 x 40 x 45 mm.

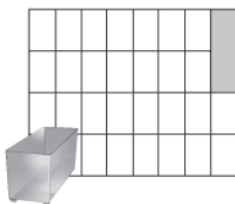

200665 Std pkg 48
 Dim.: 110 x 40 x 45 mm.

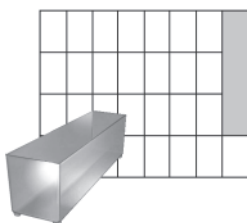

200666 Std pkg 30
 Dim.: 165 x 40 x 45 mm.

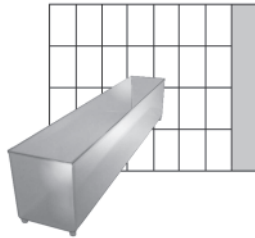

200667 Std pkg 24
 Dim.: 220 x 40 x 45 mm.

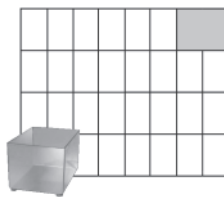

200668 Std pkg 48
 Dim.: 55 x 80 x 45 mm.

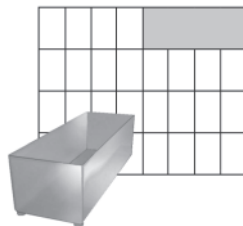

200669 Std pkg 24
 Dim.: 55 x 160 x 45 mm.

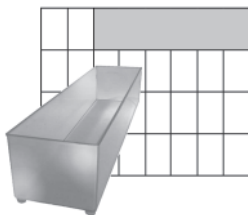

200670 Std pkg 15
 Dim.: 55 x 240 x 45 mm.

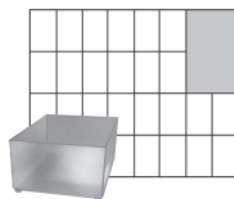

200671 Std pkg 24
 Dim.: 110 x 80 x 45 mm.

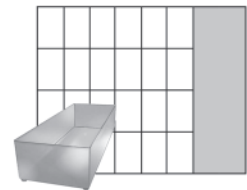

200672 Std pkg 12
 Dim.: 220 x 80 x 45 mm.

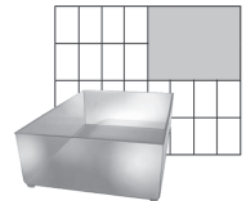

200673 Std pkg 12
 Dim.: 110 x 160 x 45 mm.



200676
 Display for 4 Profi Service Cases.
 Dim.: 330 x 360 x 200 mm



200693
 Display for 4 Profi service cases.
 Dim.: 313 x 373 x 265 mm
 Can be assembled horizontally or vertically.

Alternator Parts Replacing BOSCH

802019

131294	Diode	10	135237	Bearing cap	2
131828	Bearing cap	2	140438	Washer	5
132769	Bearing cap	2	140439	Washer	5
132804	Plug	2	140524	Sleeve	2
133373	B+ terminal M8 x 51.5	2	190259	Multiple connector 3-pole	3
133374	B+ terminal M8 x 48	2	190762	Multiple connector 4-pole	3
133401	Slip ring	2	191292	Thru bolt M5x110/40	10
133402	Slip ring	2	BX182 2	Brush set	5
134552	Washer	5	BX185 2	Brush set	5
134555	Latch	10	BX198 2	Brush set	5
134557	Terminal lock	10	BX202 2	Brush set	5
134558	Terminal lock	10	BX204 2	Brush set	5
135060	Felt	10	BX213 2	Brush set	5
135172	Slip ring	1			
135174	Brush spring	5			



Free Wheel Pulleys Replacing BOSCH

802033

	Grooves	Bore	O.D.	W.	
138073	6	17	55.7	33.5	1
138203	6	17	56	42.4	1
138282	5	17	56	37.2	1
138807	6	17	55.5	33.5	1
139281	6	17	49.5	40.7	1
230083	5	17	56	35.5	1
230292	6	17	50	40.5	1
230293	6	17	56	42.5	1



Alternator Mounting Parts Replacing BOSCH

802017

131820	Bushing mounting set	2	134541	Repair kit	2
131821	Bushing mounting set	2	134774	Bushing	10
131823	Insulator	2	134775	Bushing	10
131824	Insulator	2	134964	Bushing	5
131825	Insulator	2	135061	Tension pin	5
132081	Insulator	2	135211	Bushing	10
132324	Key	10	135216	Bushing	5
132397	Rubber mounting bushing	2			
132398	Rubber mounting bushing	2			
132767	Insulator	2			
132768	Insulator	2			
132806	Insulator	2			
132807	Insulator	2			
133641	Bushing mounting kit	2			
133785	Key	10			



Alternator Parts Replacing DELCO Eur.

802001

130668	Regulator	5
130674	Diode trio	5
130843	Slip ring	5
132346	Nut	10
132581	Washer	10
132582	Washer	10
132611	Diode trio HD	5
133198	Terminal B+	10
133497	Insulator	5
134140	Connector	5
134870	Brush spring	10
140115	Needle bearing (56769)	10
B140088P	Bearing (6203-2Z/C3)	5
RX103E 2	Brush set	5
RX103F 2	Brush set	10



Alternator Parts Replacing DELCO US

802020

130549	Brush box	1	133949	Spacer	2
130558	Brush box	1	135005	Battery terminal kit	5
130561	Slip ring	2	140120	Needle bearing	5
130668	Regulator	2	140134	Brush set	5
131418	Diode trio	2	140135	Brush set	5
131476	Brush box	1			
131504	Battery terminal kit	5			
132295	Slip ring	2			
132346	Nut	5			
132581	Washer	10			
132582	Washer	10			
133867	Diode trio	2			
133945	Spacer	2			
133946	Spacer	2			
133948	Spacer	2			



Alternator Parts - CS 121, 130, 144 Repl. DELCO US

802021

131915	Brush box	2	133948	Spacer	2
131916	Brush box	2	134077	Screw	10
131924	Cover	1	134526	Regulator repair harness	2
132047	Cover	2	134656	Adaptor kit	3
132346	Nut	5	140120	Needle bearing	5
132581	Washer	10	140598	Brush set	5
132582	Washer	10	191307	Hex flange nut M5	20
133038	Tolerance ring	5			
133924	Slip ring	2			
133928	Terminal kit	5			
133929	Cover stator lead	1			
133935	Terminal kit	5			
133945	Spacer	2			
133946	Spacer	2			
133947	Spacer	2			



Vacuum Pump Parts Replacing HITACHI

802007

080253	Hollow screw M10-1.5	2	136873	Valve	1
080256	Hollow screw M16-1.5	2	139964	Rotor vacuum pump	1
132297	Oil seal	4	190806	Sealing ring 10x16x1 mm	10
132659	O-ring	5	190818	Sealing ring 16x22x1.5 mm	10
132660	O-ring	5			
132661	Oil seal	4			
133277	Rotor vanes set	2			
133279	Rotor vanes set	2			
134290	Screw plug	2			
134394	Rotor vacuum pump	1			
134490	O-ring	5			
135129	Valve set	1			
135130	Valve set	1			
135131	Valve set	1			
135453	Ring nipple	1			



Alternator Parts Repl. LADA / MAGNETI MARELLI

802015

130703	Brush box	2	JX30-31 2	Brush set	5
130704	Brush box	2	JX32 2	Brush set	10
130813	Key	5	JX42 2	Brush set	10
130936	Key	5			
131554	Brush box	1			
131692	Diode trio	5			
131693	Diode trio	5			
132323	Connection	5			
132572	Bushing mounting kit	2			
133401	Slip ring	4			
133784	Key	5			
134727	Rivet	10			
134730	Insulator	10			
140116	Bearing	4			
140265	62202-2RS1 bearing	2			

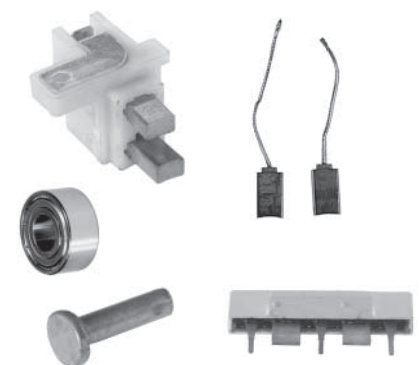

Alternator Parts Replacing LUCAS

802016

130813	Key	10	134451	Wire for rectifier	5
130910	Nut / washer	5	140120	Needle bearing	4
131292	Diode	10	140161	Brush set	5
131293	Diode	10	140240	Needle bearing	4
131342	Slip ring	2	140444	Brush set	5
131817	Slip ring	2	140613	Brush set	5
132319	Oil seal	5	LAX31-32	Brush set	5
132642	Slip ring	2			
132804	Plug	2			
133802	Insulator	2			
134038	Fitting kit	2			
134039	Fitting kit	2			
134101	Rotor wire separator	2			
134102	Rotor wire separator	2			
134345	Terminal	5			



Alternator Parts Replacing MITSUBISHI

802008

132080	Nut	2	134671	Insulator	5
133092	Terminal	1	134717	Insulator	2
133093	Terminal	1	134718	Insulator	1
133251	Terminal	1	134719	Repair plug	1
133252	Plug	1	134996	Coupler	1
133409	Slip ring (copper)	1	134999	Coupler	1
133560	Terminal	2	135000	Coupler	1
133612	Nut set	2	232778	Coupler	2
133701	Connector	2	135140	Slip ring (steel)	1
133704	Diode positive	10	135957	Terminal	1
133705	Diode negative	10	140352	JMTX-22 brush set	5
133980	Insulator	10	140354	JMTX-33 brush set	5
134273	Spacer	2	140437	JMTX-35 brush set	5
134276	Mounting bushing	2			
134277	Mounting bushing	2			
134278	Mounting bushing	2			



Vacuum Pump Parts Replacing MITSUBISHI

802009

080252	Hollow screw M10-1	2	135133	Valve set	1
080255	Hollow screw M14-1.5	2	135134	Valve set	1
132659	O-ring	5	137046	Vacuum pump connector kit	1
132660	O-ring	5	190806	Sealing ring 10x16x1 mm	10
132662	Oil seal kit	2	190815	Sealing ring 14x20x1.5 mm	10
132663	Oil seal kit	2	190820	Sealing ring 18x24x1.5 mm	10
132664	Oil seal kit	2	191358	Sealing ring 12x24x1 mm	10
133280	Rotor vane set	2			
133585	Rotor vane set	2			
133598	O-ring	5			
133962	Rotor vane set	2			
134290	Screw plug	2			
134482	O-ring	5			
135132	Valve set	1			

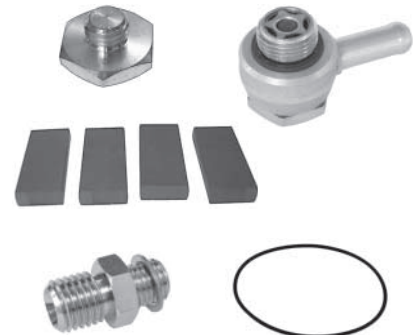

Alternator Parts Replacing MOTOROLA

802013

130903	6200 bearing cap S.R.E.	2
130933	Brush box	2
130976	Brush box	2
131218	Slip ring	2
131219	Slip ring	2
131605	Bracket mtg. bushing kit	2
131818	Slip ring	2
132097	Diode trio	4
132237	Terminal kit	2
132317	Brush box	2
132324	Key	5
133055	Slip ring	2
134781	Mounting plate	2
MX1 2	Brush set	10
SVX7 2	Brush set	10

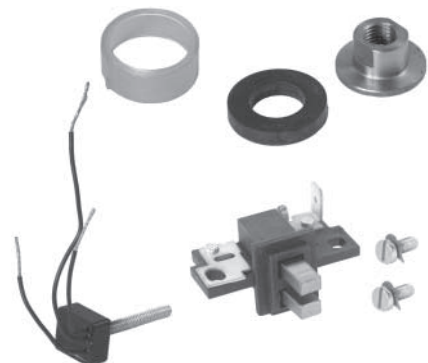

Alternator Parts Replacing NIPPONDENSO
802004

132556	Brush box	1
132558	Brush box	1
132783	Insulator	2
132784	Insulator	2
133408	Slip ring	2
133677	Wires	1
134273	Spacer	2
134374	Insulator	2
134409	Plug	1
134664	Insulator	2
134668	Insulator	2
134669	Insulator	2
134998	Coupler	1
135001	Socket	1
140368	JNDX-30 brush set	5

140369	JNDX-32 brush set	5
191298	Rotor shaft nut M14-1.5	5
191308	Hex flange nut M6	20

Alternator Parts, IF Replacing NIPPONDENSO
802003

131819	Slip ring	5
132065	Seal	2
132066	Insulator	5
132067	Insulator	2
132084	Brush box	2
132785	Insulator	2
132862	Repair plug	1
133525	Insulator	2
133673	Brush box	2
133676	Insulator	5
133678	Stud	5
133679	Seal	2
133680	Seal	2
133915	Insulator	2
134273	Spacer	2

134720	Repair plug	1
134721	Repair plug	1
134768	Washer 12 x 22 x 2 mm	5
135173	Slip ring	2
140365	JNDX-11 brush set	5
140370	JNDX-33 brush set	5
191298	Hx nut M14-1.5	5
191308	Hx flange nut M6	20

Vacuum Pump Parts Replacing NIPPONDENSO
802005

080001	Hollow screw M10-1.25	2
080255	Hollow screw M14-1.50	2
132549	Oil seal	2
133040	O-ring	5
133281	Rotor vane set	2
133282	Rotor vane set	2
133283	Rotor vane set	2
133513	Oil seal	2
133514	Filtering cloth	2
133523	Oil seal	2
133524	Oil seal	2
133527	Filtering cloth	2
133597	O-ring	5
133813	Rotor vane set	1
134293	Valve	1

134294	Valve	1
134395	Rotor vacuum pump	1
134396	Rotor vacuum pump	1
134760	Felt	2
134766	Rubber gasket	2
134767	Felt	2
135135	Valve	1
135136	Valve	1
080009	Sealing ring 10x14x1.0 mm	10
190815	Sealing ring 14x20x1.5 mm	10
190819	Sealing ring 18x22x1.5 mm	10
190820	Sealing ring 18x24x1.5 mm	10

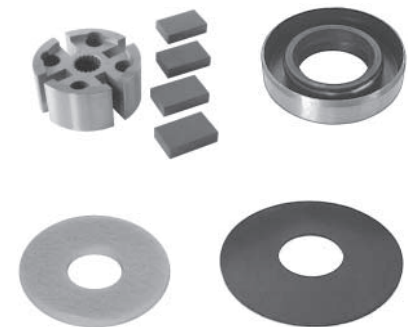
Alternator Parts Repl. PARIS RHONE / VALEO
802014

130842	Slip ring	2
130903	Tolerance ring	2
131055	Fuse	5
131583	Fuse	5
131606	Mounting bushing kit	2
131814	Slip ring	1
131815	Slip ring	1
131826	Cap	2
131827	Cap	2
131828	Bearing cap	2
132295	Slip ring	2
132848	Insulator	5
133351	Slip ring	1
133365	Copper ring	2
133366	Copper ring	2

133648	Bearing cap	2
133739	Terminal post	5
133740	Terminal post	5
134144	Connection	5
135169	Terminal cap	5
PX52-54 2	Brush set	5
PX58 2	Brush set	5
PX60 2	Brush set	2



Alternator Parts Replacing SEV

802022

130682	Diode trio	2	SVX7 2	Brush set	5
130713	Brush box	1	SVX9 2	Brush set	5
130714	Brush box	1			
130718	Slip ring	2			
131037	Slip ring	2			
131608	Mounting bushing kit	5			
131704	Brush box	1			
131822	Nut	5			
131827	Cap	2			
132080	Nut	5			
132320	Cover	2			
133199	3-pin terminal	2			
133351	Slip ring	2			
133650	Wire clip	10			
SVX5 2	Brush set	5			

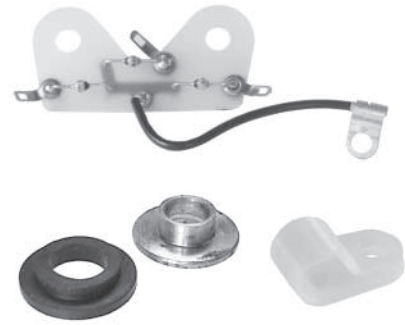

VARIOUS - IC Regulator for Hi / Mi / ND

802024

130834	IC Regulator	1	133246	IC Regulator	1
131287	IC Regulator	1	133247	IC Regulator	1
131528	IC Regulator	1	133248	IC Regulator	1
132292	IC Regulator	1	133249	IC Regulator	1
132434	IC Regulator	1	133250	IC Regulator	1
133235	IC Regulator	1	133258	IC Regulator	1
133236	IC Regulator	1	133259	IC Regulator	1
133238	IC Regulator	1	135023	IC Regulator	1
133239	IC Regulator	1	135025	IC Regulator	1
133240	IC Regulator	1	135026	IC Regulator	1
133241	IC Regulator	1	136284	IC Regulator	1
133242	IC Regulator	1			
133243	IC Regulator	1			
133244	IC Regulator	1			
133245	IC Regulator	1			

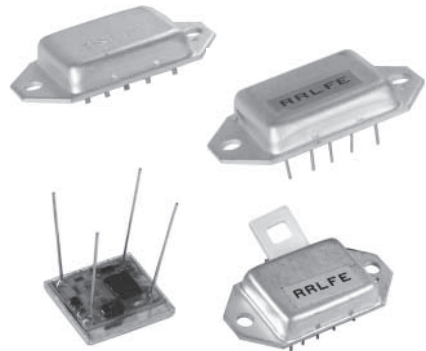

VARIOUS - Diodes • Alternators

802011

130669	Diode	6	131511	Diode	6
130670	Diode	6	131512	Diode	6
130671	Diode	6	131513	Diode	6
130672	Diode	6	131514	Diode	6
130911	Diode	6	133193	Diode	6
130912	Diode	6	133194	Diode	6
130937	Diode	6	133495	Diode	3
131292	Diode	6	133496	Diode	3
131293	Diode	6	133704	Diode	6
131294	Diode	6	133705	Diode	6
131506	Diode	6	134519	Diode	6
131507	Diode	6	135152	Diode	6
131508	Diode	6	135153	Diode	6
131509	Diode	6	135213	Diode	6
131510	Diode	6			



VARIOUS - Slip Rings

802032

131342	Slip Ring Lu	2	138441	Slip Ring Lu	1
131814	Slip Ring PR	2			
131816	Slip Ring Du	2			
131817	Slip Ring Lu	2			
132642	Slip Ring Lu	2			
133351	Slip Ring PR	2			
133401	Slip Ring Bo	2			
133402	Slip Ring Bo	2			
133409	Slip Ring (Copper) Mi	2			
133410	Slip Ring Hi	2			
133924	Slip Ring DR	2			
135054	Slip Ring Hi	2			
135140	Slip Ring (Steel) Mi	2			
135173	Slip Ring PR	2			
135315	Slip Ring ND	2			



VARIOUS - Brushes
802031

140342	Brush set Hi	2
140343	Brush set Hi	2
140351	Brush set Mi	2
140353	Brush set Mi	2
140365	Brush set ND	2
140367	Brush set ND	2
140369	Brush set ND	2
140380	Brush set Hi	2
140437	Brush set Mi	2
BX182 2	Brush set Bo	2
BX185 2	Brush set Bo	2
LAX31-32 2	Brush set Lu	2
MX1 2	Brush set Mo	2
PX52-54 2	Brush set PR	2
RX103F 2	Brush set DR	2

SVX7 2	Brush set SE	2
--------	--------------	---

VARIOUS - Brushes • Japanese Alternators
802027

140342	Brush set, Hi	2
140343	Brush set, Hi	2
140351	Brush set, Mi	2
140352	Brush set, Mi	2
140353	Brush set, Mi	2
140354	Brush set, Mi	2
140365	Brush set, ND	2
140367	Brush set, ND	2
140368	Brush set, ND	2
140369	Brush set, ND	2
140370	Brush set, ND	2
140371	Brush set, ND	2
140380	Brush set, Hi	2
140437	Brush set, Mi	2
140576	Brush set, Mi	2

140577	Brush set, Mi	2
--------	---------------	---

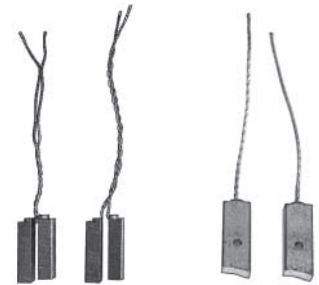
VARIOUS - Special Bearings • Jap. Alternators
802002

140231	Bearing	1
140232	Bearing	1
140233	Bearing	1
140234	Bearing	1
140235	Bearing	1
140236	Bearing	1
140237	Bearing	1
140239	Bearing	1
140417	Bearing	1
140419	Bearing	1
140420	Bearing	1
140432	Bearing	1
140434	Bearing	1
140441	Bearing	1
140443	Bearing	1

140460	Bearing	1
140461	Bearing	1
140462	Bearing	1
140588	Bearing	1
140589	Bearing	1

VARIOUS - Special Bearings • Eur. Alternators
802025

140105	62201 2RS1	1
140106	WR 8-ZZ	1
140115	56769 needle bearing	1
140116	Bearing	1
140120	Needle bearing	1
140176	Bearing	1
140240	Needle bearing	1
140263	Bearing	1
140265	62202 2RS1	1
140266	62303 2RS1	1
140401	6305/17 2RS1/C3 HT51	1
140442	62304 2RS1	1
140515	NU202E	1
140516	NU205E	1
140569	Bearing	1



VARIOUS - Small Bearings • Alternators

802026

140222	608 2RS1/C3	5	B140220P	6206 2RS1/C3	2
140296	607 2Z/C3	5	B140223P	6004 2RS1/C3	2
140300	627 2Z/C3	5	B140271P	6000 2RS1/C3	5
140301	629 2Z/C3	5	B140272P	6002 2RS1/C3	5
140459	625 2RS1/C3	5	B140273P	6003 2RS1/C3	5
140523	626 2RS1/C3	5	B140274P	6005 2RS1/C3	2
B140077P	6001 2RS1/C3	5	B140277P	6301 2RS1/C3	2
B140079P	6200 2RS1/C3	5	B140278P	6205 2RS1/C3	2
B140081P	6201 2RS1/C3	5	B140635P	6300 2RS1/C3	2
B140084P	6202 2RS1/C3	2			
B140087P	6203 2RS1/C3	2			
B140091P	6302 2RS1/C3	2			
B140093P	6303 2RS1/C3	2			
B140218P	6204 2RS1/C3	2			
B140219P	6205 2RS1/C3	2			



VARIOUS - Needle Bearings

802035

140242	Needle bearing	5	140752	Needle bearing	2
140375	Needle bearing	2	140767	Needle bearing	1
140421	Needle bearing	2	140768	Needle bearing	1
140468	Needle bearing	2	140807	Needle bearing	3
140482	Needle bearing	5	140876	Needle bearing	1
140483	Needle bearing	2	140903	Needle bearing	1
140494	Needle bearing	10	140904	Needle bearing	2
140495	Needle bearing	2	140919	Needle bearing	2
140503	Needle bearing	2	140935	Needle bearing	2
140514	Needle bearing	2	141001	Needle bearing	2
140552	Needle bearing	1	141039	Needle bearing	2
140617	Needle bearing	5	141054	Needle bearing	2
140619	Needle bearing	5	141090	Needle bearing	2
140620	Needle bearing	5	141168	Needle bearing	2
140738	Needle bearing	1	141209	Needle bearing	2
140751	Needle bearing	5	141219	Needle bearing	2



VARIOUS - Oil Seals for Alternators

802029

132297	Oil seal	5	138130	Oil seal	1
132319	Oil seal	5	138369	Oil seal	5
132549	Oil seal	3			
132661	Oil seal	5			
132662	Oil seal kit	1			
132663	Oil seal kit	1			
132664	Oil seal kit	1			
132734	Oil seal	5			
133065	Oil seal	3			
133513	Oil seal	5			
133523	Oil seal	5			
133524	Oil seal	5			
136014	Oil seal	3			
136016	Oil seal	1			
137803	Oil seal set	1			



VARIOUS - Bearing Caps • Alternators

802034

130903	Bearing cap, PR	3	139952	Bearing cap, Lu	3
131826	Bearing cap, PR	3			
131827	Bearing cap, PR	3			
131828	Bearing cap, Bo/PR	3			
132769	Bearing cap, Bo	2			
133648	Bearing cap, PR	3			
134428	Bearing cap, DR	3			
135170	Bearing cap, PR	3			
135171	Bearing cap, PR	3			
135237	Bearing cap, Bo	3			
135407	Bearing cap, Bo	2			
135508	Bearing cap, PR	3			
136235	Bearing cap, Bo	3			
139681	Bearing cap, La	3			
139929	Bearing cap, Bo	2			



VARIOUS - Bearings Tolerance Rings · Alternators 802010

140131	Bearing tolerance ring	3	140651	Tolerance ring	2
140132	Bearing tolerance ring	2	140699	Tolerance ring	3
140133	Bearing tolerance ring	2	140700	Tolerance ring	3
140243	Tolerance ring	5	140701	Tolerance ring	3
140244	Tolerance ring	5	140702	Tolerance ring	3
140245	Tolerance ring	5	140703	Tolerance ring	3
140246	Tolerance ring	3	140718	Tolerance ring	5
140247	Tolerance ring	2	140719	Tolerance ring	5
140504	Tolerance ring	2	140720	Tolerance ring	5
140608	Bearing tolerance ring	3	140721	Tolerance ring	5
140609	Bearing tolerance ring	3	140722	Tolerance ring	2
140610	Bearing tolerance ring	2	140739	Bearing tolerance ring	5
140611	Bearing tolerance ring	2			
140612	Bearing tolerance ring	2			
140616	Tolerance ring	5			

VARIOUS - Spacers for Pulleys · Alternators 802023

134273	15.5x21.6x5.85 mm	5	610036	17x35, 25x10.5 mm	5
610021	17x45x6.5 mm	5	610040	17x45x2 mm	5
610022	17x30x17 mm	5	610041	17.5x35x2 mm	5
610023	17x25x18 mm	5	610061	17x45x1 mm	5
610024	17x30x8 mm	5	610062	17x27x1 mm	5
610025	17x30x12 mm	5	610063	15x25x1.5 mm	5
610026	17x25x12 mm	5			
610027	15x30x12 mm	5			
610028	17x25x16 mm	5			
610029	17x30x14.5 mm	5			
610030	17x30x6.5 mm	5			
610031	17x25x5.5 mm	5			
610032	17x25x3.5 mm	5			
610033	15x30x2.7 mm	5			
610034	15x25x9.2 mm	5			

VARIOUS - Nuts & Keys · Alternators 802028

130813	Key, Lu, MM	10
130819	Rotor shaft nut, Lu	10
130910	Rotor shaft nut, Lu	10
130936	Key, MM	10
131822	Rotor shaft nut, SE	10
132080	Rotor shaft nut set, SE, Mi	5
132324	Key, Bo	10
132346	Rotor shaft nut, DR US	10
133612	Rotor shaft nut set, Mi	10
133784	Key, MM	10
133785	Key, Bo	10
135049	Rotor shaft nut, Lu	10
191298	Rotor shaft nut	10
191299	Rotor shaft nut	10



Index for Assortments

Cargo	Assortments	Page
080001	802005	799
080009	802005	799
080252	802009	798
080253	802007	797
080255	802005	799
and	802009	798
080256	802007	797
130549	802020	797
130558	802020	797
130561	802020	797
130668	802001	796
and	802020	797
130669	802011	800
130670	802011	800
130671	802011	800
130672	802011	800
130674	802001	796
130682	802022	800
130703	802015	797
130704	802015	797
130713	802022	800
130714	802022	800
130718	802022	800
130813	802015	797
and	802016	798
and	802028	803
130819	802028	803
130834	802024	800
130842	802014	799
130843	802001	796
130903	802013	798
and	802014	799
and	802034	802
130910	802016	798
and	802028	803
130911	802011	800
130912	802011	800
130933	802013	798
130936	802015	797
and	802028	803
130937	802011	800
130976	802013	798
131037	802022	800
131055	802014	799
131218	802013	798
131219	802013	798
131287	802024	800
131292	802011	800
and	802016	798
131293	802011	800
and	802016	798
131294	802011	800
and	802019	796
131342	802016	798
and	802032	800
131418	802020	797
131476	802020	797
131504	802020	797
131506	802011	800
131507	802011	800
131508	802011	800
131509	802011	800
131510	802011	800
131511	802011	800
131512	802011	800
131513	802011	800
131514	802011	800
131528	802024	800
131554	802015	797

Cargo	Assortments	Page
131583	802014	799
131605	802013	798
131606	802014	799
131608	802022	800
131692	802015	797
131693	802015	797
131704	802022	800
131814	802014	799
and	802032	800
131815	802014	799
131816	802032	800
131817	802016	798
and	802032	800
131818	802013	798
131819	802003	799
131820	802017	796
131821	802017	796
131822	802022	800
and	802028	803
131823	802017	796
131824	802017	796
131825	802017	796
131826	802014	799
and	802034	802
131827	802014	799
and	802022	800
and	802034	802
131828	802014	799
and	802019	796
and	802034	802
131915	802021	797
131916	802021	797
131924	802021	797
132047	802021	797
132065	802003	799
132066	802003	799
132067	802003	799
132080	802008	798
and	802022	800
and	802028	803
132081	802017	796
132084	802003	799
132097	802013	798
132237	802013	798
132292	802024	800
132295	802014	799
and	802020	797
132297	802007	797
and	802029	802
132317	802013	798
132319	802016	798
and	802029	802
132320	802022	800
132323	802015	797
132324	802013	798
and	802017	796
and	802028	803
132346	802001	796
and	802020	797
and	802021	797
and	802028	803
132397	802017	796
132398	802017	796
132434	802024	800
132549	802005	799
and	802029	802
132556	802004	799
132558	802004	799
132572	802015	797

Cargo	Assortments	Page
132581	802001	796
and	802020	797
and	802021	797
132582	802001	796
and	802020	797
and	802021	797
132611	802001	796
132642	802016	798
and	802032	800
132659	802007	797
and	802009	798
132660	802007	797
and	802009	798
132661	802007	797
and	802029	802
132662	802009	798
and	802029	802
132663	802009	798
and	802029	802
132664	802009	798
and	802029	802
132734	802029	802
132767	802017	796
132768	802017	796
132769	802019	796
and	802034	802
132783	802004	799
132784	802004	799
132785	802003	799
132804	802016	798
and	802019	796
132806	802017	796
132807	802017	796
132848	802014	799
132862	802003	799
133038	802021	797
133040	802005	799
133055	802013	798
133065	802029	802
133092	802008	798
133093	802008	798
133193	802011	800
133194	802011	800
133198	802001	796
133199	802022	800
133235	802024	800
133236	802024	800
133238	802024	800
133239	802024	800
133240	802024	800
133241	802024	800
133242	802024	800
133243	802024	800
133244	802024	800
133245	802024	800
133246	802024	800
133247	802024	800
133248	802024	800
133249	802024	800
133250	802024	800
133251	802008	798
133252	802008	798
133258	802024	800
133259	802024	800
133277	802007	797
133279	802007	797
133280	802009	798
133281	802005	799
133282	802005	799

Index for Assortments

Cargo	Assortments	Page
133283	802005	799
133351	802014	799
and	802022	800
and	802032	800
133365	802014	799
133366	802014	799
133373	802019	796
133374	802019	796
133401	802015	797
and	802019	796
and	802032	800
133402	802019	796
and	802032	800
133408	802004	799
133409	802008	798
and	802032	800
133410	802032	800
133495	802011	800
133496	802011	800
133497	802001	796
133513	802005	799
and	802029	802
133514	802005	799
133523	802005	799
and	802029	802
133524	802005	799
and	802029	802
133525	802003	799
133527	802005	799
133560	802008	798
133585	802009	798
133597	802005	799
133598	802009	798
133612	802008	798
and	802028	803
133641	802017	796
133648	802014	799
and	802034	802
133650	802022	800
133673	802003	799
133676	802003	799
133677	802004	799
133678	802003	799
133679	802003	799
133680	802003	799
133701	802008	798
133704	802008	798
and	802011	800
133705	802008	798
and	802011	800
133739	802014	799
133740	802014	799
133784	802015	797
and	802028	803
133785	802017	796
and	802028	803
133802	802016	798
133813	802005	799
133867	802020	797
133915	802003	799
133924	802021	797
and	802032	800
133928	802021	797
133929	802021	797
133935	802021	797
133945	802020	797
and	802021	797
133946	802020	797
and	802021	797

Cargo	Assortments	Page
133947	802021	797
133948	802020	797
and	802021	797
133949	802020	797
133962	802009	798
133980	802008	798
134038	802016	798
134039	802016	798
134077	802021	797
134101	802016	798
134102	802016	798
134140	802001	796
134144	802014	799
134273	802003	799
and	802004	799
and	802008	798
and	802023	803
134276	802008	798
134277	802008	798
134278	802008	798
134290	802007	797
and	802009	798
134293	802005	799
134294	802005	799
134345	802016	798
134374	802004	799
134394	802007	797
134395	802005	799
134396	802005	799
134409	802004	799
134428	802034	802
134451	802016	798
134482	802009	798
134490	802007	797
134519	802011	800
134526	802021	797
134541	802017	796
134552	802019	796
134555	802019	796
134557	802019	796
134558	802019	796
134656	802021	797
134664	802004	799
134668	802004	799
134669	802004	799
134671	802008	798
134717	802008	798
134718	802008	798
134719	802008	798
134720	802003	799
134721	802003	799
134727	802015	797
134730	802015	797
134760	802005	799
134766	802005	799
134767	802005	799
134768	802003	799
134774	802017	796
134775	802017	796
134781	802013	798
134870	802001	796
134964	802017	796
134996	802008	798
134998	802004	799
134999	802008	798
135000	802008	798
135001	802004	799
135005	802020	797
135023	802024	800

Cargo	Assortments	Page
135025	802024	800
135026	802024	800
135049	802028	803
135054	802032	800
135060	802019	796
135061	802017	796
135129	802007	797
135130	802007	797
135131	802007	797
135132	802009	798
135133	802009	798
135134	802009	798
135135	802005	799
135136	802005	799
135140	802008	798
and	802032	800
135152	802011	800
135153	802011	800
135169	802014	799
135170	802034	802
135171	802034	802
135172	802019	796
135173	802003	799
and	802032	800
135174	802019	796
135211	802017	796
135213	802011	800
135216	802017	796
135237	802019	796
and	802034	802
135315	802032	800
135407	802034	802
135453	802007	797
135508	802034	802
135957	802008	798
136014	802029	802
136016	802029	802
136235	802034	802
136284	802024	800
136873	802007	797
137046	802009	798
137803	802029	802
138073	802033	796
138130	802029	802
138203	802033	796
138282	802033	796
138369	802029	802
138441	802032	800
138807	802033	796
139281	802033	796
139681	802034	802
139929	802034	802
139952	802034	802
139964	802007	797
140105	802025	801
140106	802025	801
140115	802001	796
and	802025	801
140116	802015	797
and	802025	801
140120	802016	798
and	802020	797
and	802021	797
and	802025	801
140131	802010	803
140132	802010	803
140133	802010	803
140134	802020	797
140135	802020	797

Index for Assortments

Cargo	Assortments	Page
140161	802016	798
140176	802025	801
140222	802026	802
140231	802002	801
140232	802002	801
140233	802002	801
140234	802002	801
140235	802002	801
140236	802002	801
140237	802002	801
140239	802002	801
140240	802016	798
and	802025	801
140242	802035	802
140243	802010	803
140244	802010	803
140245	802010	803
140246	802010	803
140247	802010	803
140263	802025	801
140265	802015	797
and	802025	801
140266	802025	801
140296	802026	802
140300	802026	802
140301	802026	802
140342	802027	801
and	802031	801
140343	802027	801
and	802031	801
140351	802027	801
and	802031	801
140352	802008	798
and	802027	801
140353	802027	801
and	802031	801
140354	802008	798
and	802027	801
140365	802003	799
and	802027	801
and	802031	801
140367	802027	801
and	802031	801
140368	802004	799
and	802027	801
140369	802004	799
and	802027	801
and	802031	801
140370	802003	799
and	802027	801
140371	802027	801
140375	802035	802
140380	802027	801
and	802031	801
140401	802025	801
140417	802002	801
140419	802002	801
140420	802002	801
140421	802035	802
140432	802002	801
140434	802002	801
140437	802008	798
and	802027	801
and	802031	801
140438	802019	796
140439	802019	796
140441	802002	801
140442	802025	801
140443	802002	801

Cargo	Assortments	Page
140444	802016	798
140459	802026	802
140460	802002	801
140461	802002	801
140462	802002	801
140468	802035	802
140482	802035	802
140483	802035	802
140494	802035	802
140495	802035	802
140503	802035	802
140504	802010	803
140514	802035	802
140515	802025	801
140516	802025	801
140523	802026	802
140524	802019	796
140552	802035	802
140569	802025	801
140576	802027	801
140577	802027	801
140588	802002	801
140589	802002	801
140598	802021	797
140608	802010	803
140609	802010	803
140610	802010	803
140611	802010	803
140612	802010	803
140613	802016	798
140616	802010	803
140617	802035	802
140619	802035	802
140620	802035	802
140651	802010	803
140699	802010	803
140700	802010	803
140701	802010	803
140702	802010	803
140703	802010	803
140718	802010	803
140719	802010	803
140720	802010	803
140721	802010	803
140722	802010	803
140738	802035	802
140739	802010	803
140751	802035	802
140752	802035	802
140767	802035	802
140768	802035	802
140807	802035	802
140876	802035	802
140903	802035	802
140904	802035	802
140919	802035	802
140935	802035	802
141001	802035	802
141039	802035	802
141054	802035	802
141090	802035	802
141168	802035	802
141209	802035	802
141219	802035	802
190259	802019	796
190762	802019	796
190806	802007	797
and	802009	798
190815	802005	799

Cargo	Assortments	Page
and	802009	798
190818	802007	797
190819	802005	799
190820	802005	799
and	802009	798
191292	802019	796
191298	802003	799
and	802004	799
and	802028	803
191299	802028	803
191307	802021	797
191308	802003	799
and	802004	799
191358	802009	798
230083	802033	796
230292	802033	796
230293	802033	796
232778	802008	798
610021	802023	803
610022	802023	803
610023	802023	803
610024	802023	803
610025	802023	803
610026	802023	803
610027	802023	803
610028	802023	803
610029	802023	803
610030	802023	803
610031	802023	803
610032	802023	803
610033	802023	803
610034	802023	803
610036	802023	803
610040	802023	803
610041	802023	803
610061	802023	803
610062	802023	803
610063	802023	803
B140077P	802026	802
B140079P	802026	802
B140081P	802026	802
B140084P	802026	802
B140087P	802026	802
B140088P	802001	796
B140091P	802026	802
B140093P	802026	802
B140218P	802026	802
B140219P	802026	802
B140220P	802026	802
B140223P	802026	802
B140271P	802026	802
B140272P	802026	802
B140273P	802026	802
B140274P	802026	802
B140277P	802026	802
B140278P	802026	802
B140635P	802026	802
BX182 2	802019	796
and	802031	801
BX185 2	802019	796
and	802031	801
BX198 2	802019	796
BX202 2	802019	796
BX204 2	802019	796
BX213 2	802019	796
JX30-31 2	802015	797
JX32 2	802015	797
JX42 2	802015	797
LAX31-31 2	802016	798

Index for Assortments

Cargo	Assortments	Page
LAX31-32 2	802031	801
MX1 2	802013	798
and	802031	801
PX52-54 2	802014	799
and	802031	801
PX58 2	802014	799
PX60 2	802014	799
RX103E 2	802001	796
RX103F 2	802031	801
and	802001	796
SVX5 2	802022	800
SVX7 2	802013	798
and	802022	800
and	802031	801
SVX9 2	802022	800

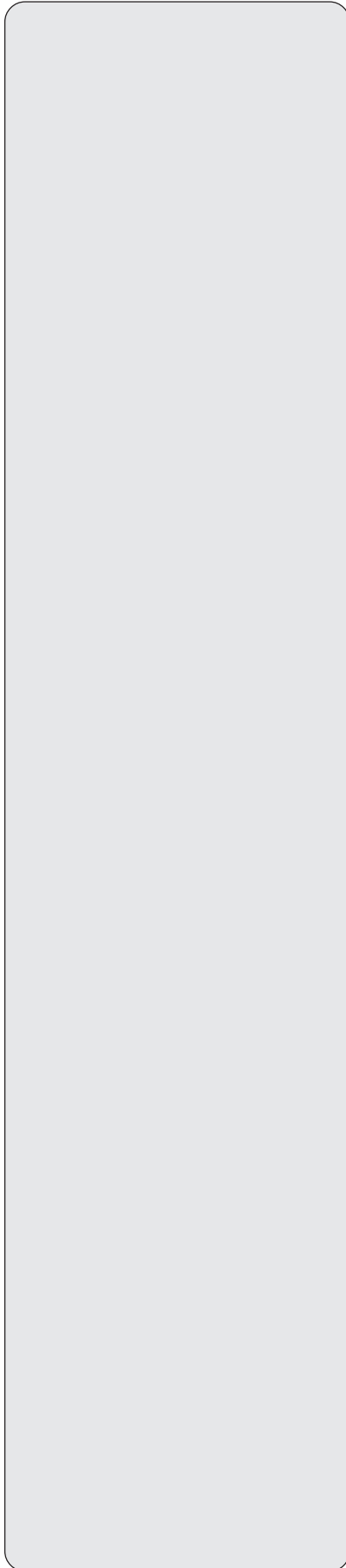
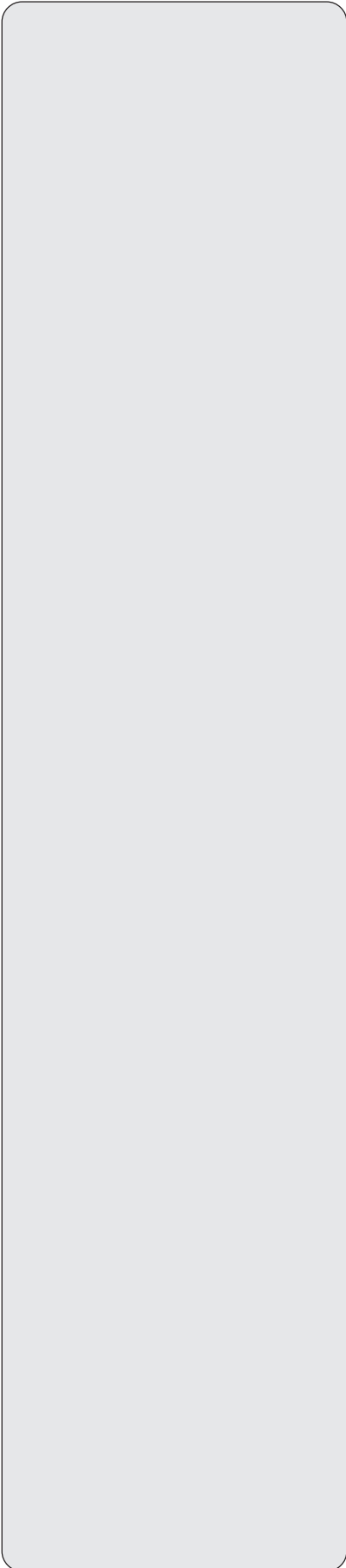

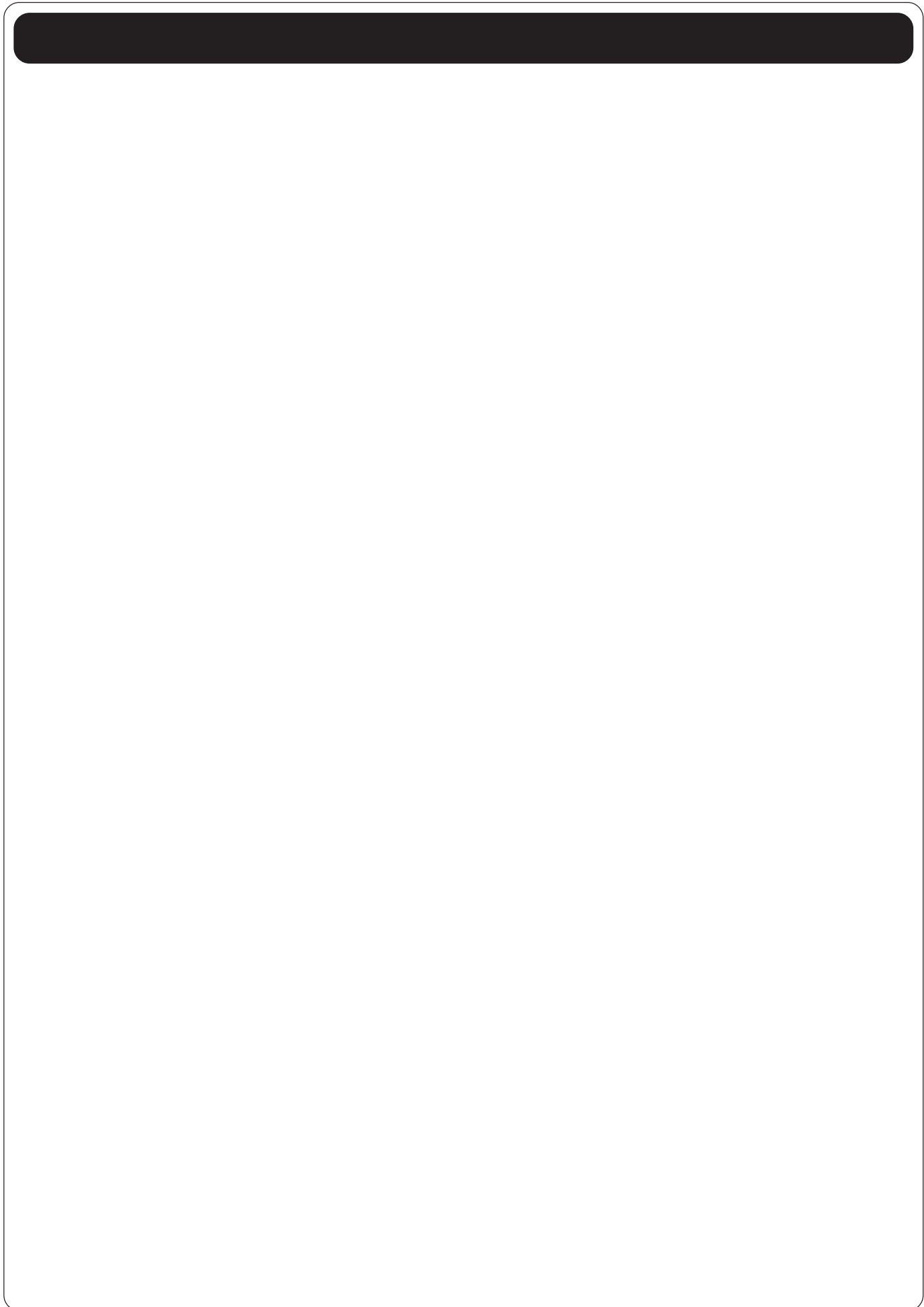



PULLEY SURVEY, & MOUNTING BUSHING SURVEY

PART 2
16th Edition



Pulley Survey

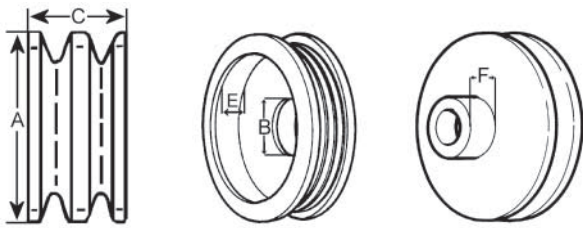

SINGLE PULLEY

TYPE A BELT, 9.5 mm top width

B Bore	A O.D.	C Width	E Depth	F Distance-back	Cargo
15	61.96	29.40	17.75	5.85	137682
15	62.07				139947
15	62.09	26.29	11.94		135741
15	62.89	20.23	13.89		139345
15	67.02	19.00	7.78	4.84	137689
15	67.77				134712
15	68.60	21.40			131027
15	68.69	21.85			610009
15	68.80	20.40			234913
15	69.44	25.52	9.60	9.75	133698
15	71.77	21.60			610007
15	72.34				135594
15	72.65	20.59			132592
15	72.72	20.58			131204
15	80.00				134943
15	83.25	20.30	6.15		234777
15	104.49	37.62			136954
15.88(5/8")	65.92	20.39	4.47		133405
17	61.92	16.38			138339
17	62.06	15.98			136676
17	62.08	13.08	5.82		230719
17	62.50	21.00		3.90	231673
17	62.92	19.87			231675
17	64.36	32.29	14.26	14.47	135944
17	64.53	16.38			133936
17	65.28	22.24	6.22	3.40	230535
17	66.98	13.57	5.54		136843
17	67.78				230037
17	67.86	49.25	30.08	33.58	131200
17	67.96	16.51	7.70	2.92	137369
17	68.45	20.90			610002
17	68.53	21.71			131196
17	68.94	53.68	39.12	36.79	232346
17	69.00	18.00	17.00		235294
17	69.19	29.00	20.61	12.51	232356
17	69.65	45.80	30.23	29.49	137250
17	70.70	12.82			233618
17	71.43				136364
17	71.80	21.40			131201
17	71.89	18.93			230960
17	72.00	35.36	25.94	16.16	610008
17	72.60	20.95			610005
17	73.37	21.04	13.70	3.00	138063
17	74.46	20.86	13.54		231375
17	75.00	16.15	6.28		137962
17	75.22	21.00			610003
17	75.63	20.81			131198
17	75.65	34.16	16.62	11.09	232122
17	78.50	21.60			234096
17	78.85	20.20	13.30		234672
17	81.76	26.20	11.37	9.47	136955

B Bore	A O.D.	C Width	E Depth	F Distance-back	Cargo
17	83.40	21.30			131193
17	83.50	21.59			610001
17	83.98	17.05			232351
17	89.00	19.00	10.68		233865
17	89.00	21.17	10.57	5.24	234025
17	89.23	15.23			236120
17	92.09	23.43		11.08	139864
17	93.46				139984
17	96.30	21.26	10.93	4.76	137650
20	96.94	18.11			136291

TYPE B BELT, 12.5 mm top width

B Bore	A O.D.	C Width	E Depth	F Distance-back	Cargo
15	68.38				139273
15	68.91	21.94	6.79	5.38	137658
15	68.91	30.54	18.47	10.90	137969
15	72.00	23.23	7.26		231376
15	73.55	27.05			133884
15	73.61				134711
15	74.02	22.93	14.82		137968
15	74.39	20.06	8.75		136152
15	83.41				230319
15	87.80	29.83	10.97	10.11	232148
15.88(5/8")	78.13	19.43			232159
15.88(5/8")	78.95	19.57			133406
17	65.82	23.46	4.53		232084
17	72.16	26.66	10.33	8.97	136953
17	73.40				135272
17	73.79	27.76	11.81		233604
17	73.90	27.91	10.66		139309
17	75.12	38.22			232075
17	75.34	32.93	13.83	3.49	232150
17	76.44	21.56	9.09	3.77	137941
17	77.94	27.83			135274
17	80.00	19.11	15.60		138372
17	80.20	17.45	6.32		231519
17	80.40	18.06	9.44		230289
17	81.28	22.98		3.39	232080
17	83.10				137552
17	83.62	30.66		10.43	230504
17	83.63				131048
17	83.79	22.61	6.55		136149
17	83.89	20.35			136156
17	83.90	26.27	9.53	6.65	230955
17	84.29	19.11			136117
17	85.09	26.59		3.66	232119
17	93.16	19.93			135057
17/15	93.46	20.43	7.85		135058
19/25	81.67	26.29			136095
20	74.48	21.13			136102
20	76.42	35.89	22.48	4.20	136078
20	92.69	28.80			133815
22.23(7/8")	90.55	34.03		13.40	232110

TYPE C BELT, 17.5 mm top width

B Bore	A O.D.	C Width	E Depth	F Distance-back	Cargo
15	73.32	29.75	12.68		233489
15	76.14	36.47	24.71	6.37	135627
15	82.00	24.11	7.54		231108
15/19.5	82.36	45.42	16.84	6.03	137961
15	83.32				135265
15	87.07	24.41	10.75	5.34	137393
15	93.00				133883

Pulley Survey

TYPE C BELT, 17.5 mm top width

B Bore	A O.D.	C Width	E Depth	F Distance-back	Cargo
15	94.72	24.13		8.59	232143
17	78.25	25.55	6.41	3.40	232167
17	81.72	26.24	11.17		136155
17	81.78	26.94	12.15		234278
17	81.86	27.19	12.37		139308
17	83.02	25.00	7.58		137551
17	83.30				135267
17	88.35	25.58	7.18	6.54	230505
17	93.35	27.65		7.40	232144
17	93.49	22.52			136960
17	93.84	23.16			139243
17	94.22	22.49	7.47		139248
17	96.96	25.45	10.50	5.13	137672
17	107.21	37.75	18.40	3.18	232081
20	81.69	43.29	30.60	3.82	137967
20	81.87	25.43	11.85	4.41	137666
20	92.02	40.37	27.13		230952
22.23(7/8")	104.77	33.31		5.24	232105
25	87.00	36.34	10.80		232338

DOUBLE PULLEY

TYPE A BELT, 9.5 mm top width

B Bore	A O.D.	C Width	E Depth	F Distance-back	Cargo
15	65.95	30.58	17.82		133346
15	66.69	32.65	10.63	4.73	133584
15	69.03/74.01	32.84	20.86		135629
15	71.19	36.78	24.18	4.91	230507
15	71.20	32.33	20.84	5.48	230506
15	86.07	33.00	22.23		136098
15.88(5/8")	71.46	29.86	14.29		232160
17	60.00	30.09	17.15		233132
17	60.88	34.83	22.35	1.39	131928
17	62.52	32.53	19.99		135178
17	63.00	34.20	18.98	3.78	233916
17	64.24	46.17	31.43		139696
17	64.36	42.87	24.66	3.71	232086
17	65.53	38.12	21.98	3.32	230536
17	66.56	35.56	18.29	3.59	232120
17	66.79	27.33	8.95		134938
17	67.49	53.32		10.25	232077
17	69.05	38.03	17.95	3.11	133951
17	71.54	33.27	16.05		230791
17	71.86	35.66	18.15		134325
17	71.94	36.65	18.76	8.28	232354
17	72.06	34.14	23.10	5.98	136453
17	72.70	36.44	22.27	6.63	231674
17	73.69	32.15	23.99		134007
17	75.05	37.46			610006
17	76.20	37.79			131203
17	76.55	33.12	20.61	4.79	231109
17	76.96	36.43	18.09	6.81	138624
17	83.00	30.87	22.79		135744
17	83.44	36.55	12.61		137553
17	84.00	32.00			230794
17	84.00	34.50	18.42		234028
17	89.00	34.41	11.57	4.09	232357
17	92.00	36.66	19.64		234029
20	67.05	37.48	25.95		133688
20	76.89	45.54	33.49		135628
22.35(0.880")	77.78	39.00	19.90	3.45	232142

TYPE B BELT, 12.5 mm top width

B Bore	A O.D.	C Width	E Depth	F Distance-back	Cargo
15	74.63	38.50	25.09		137699
15.88(5/8")	79.10	35.52	18.52		232161
17	71.52	50.15	33.80	3.42	133952
17	71.74	37.22	25.59		134920
17	75.15	39.74	21.98	3.79	232124
17	79.15	35.38	21.31		133699
17	79.54	34.95	19.76		136157
17	80.05	44.48	30.92	6.02	230530
17	81.30	40.71	21.43	3.37	232083
17	81.31	54.55		18.28/15.65	232076
17	83.82	44.29	30.68	6.53	231114
17	83.93	36.66	20.17	7.49	230792
17	84.02	37.34	12.99		136159
17	87.70	35.96	18.69		134684
17	88.00	37.87	21.38	10.85	231671
17	88.03	37.17	11.42	7.87	137433
17	93.87	46.75	25.44	8.19	137608
22.23(7/8")	75.49	49.74	16.41	13.57	232106
22.23(7/8")	78.77	39.80	6.35	4.47	131176
22.23(7/8")	82.70	34.85		1.69	232147
22.23(7/8")	85.00	44.20	10.55	3.40	232109
22.23(7/8")	88.90	59.35	25.27	8.58	232103
22.23(7/8")	89.44	39.60	6.26	5.38	232111
22.23(7/8")	108.42	40.80		7.55	232145
22.23(7/8")	122.28	59.06	19.00	21.81	232104
22.35(0.880")	84.37	41.79	22.46	3.51	232141
30	104.95	34.88			133508
30	106.78	35.07			137818

TYPE C BELT, 17.5 mm top width

B Bore	A O.D.	C Width	E Depth	F Distance-back	Cargo
17	111.63	59.67	35.67	12.81	232082
22.23(7/8")	91.00				232168
22.23(7/8")	95.00				232118
22.23(7/8")	95.05	58.78	26.86		232332

TRIPPLE PULLEY

TYPE A BELT, 9.5 mm top width

B Bore	A O.D.	C Width	E Depth	F Distance-back	Cargo
17	81.95	68.08	23.11		135596

TYPE B BELT, 12.5 mm top width

B Bore	A O.D.	C Width	E Depth	F Distance-back	Cargo
22.23(7/8")	72.56	55.89	26.21		232107
22.23(7/8")	87.83	55.52	22.08	3.83	232108
22.23(7/8")	108.10	56.72	17.60	10.36	232146

Pulley Survey

MISCELLANEOUS

SINGLE BELT 11

B Bore	A O.D.	C Width	E Depth	F Distance-back	Cargo
17	62.75	20.07		3.37	232085

SINGLE BELT 16-19

B Bore	A O.D.	C Width	E Depth	F Distance-back	Cargo
17	62.62	26.34	7.50	3.18	232149

DOUBLE BELT 16

B Bore	A O.D.	C Width	E Depth	F Distance-back	Cargo
17	78.44	47.66	28.68	3.35	232151

DOUBLE BELT 22

B Bore	A O.D.	C Width	E Depth	F Distance-back	Cargo
22.23(7/8")	93.63	93.28	59.54	25.45	232117

DOUBLE A + B BELT

B Bore	A O.D.	C Width	E Depth	F Distance-back	Cargo
17	71.80	39.03	21.57	4.04	232123
17	84.86	41.86	22.69	3.70	232121

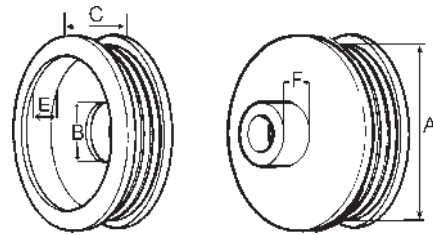

SERPENTINE PULLEY

Grooves	B Bore	A O.D.	C Width	E Depth	F Distance-back	Cargo
3	15	48.51	20.71	4.53	6.06	133868
3	15	57.08	21.43	11.74	4.23	133344
3	15	57.50	20.29	5.14	8.54	230957
3	15	59.86	24.90	9.65	9.43	133690
3	17	54.85	15.88		0.87	135561
3	17	54.89	18.95	7.61		134919
3	17	55.20	20.40	4.91		135425
3	17	55.45	29.81	16.77		133692
3	17	57.00	24.10	13.21	3.10	135510
3	17	58.18	39.65	23.86		135512
3	17	59.92	23.56	13.51		135742
3	17	60.00	27.00	17.00		235039
3	17	63.66	40.75	26.31		232341
3	17	63.71	28.05	12.66	3.83	138657
3	17	63.80	23.84	12.26		136198
3	17	64.88	19.23	12.07		137471
3	17	71.00	19.23	6.33	8.14	132836
4	15	49.00	22.72	13.15	4.37	133517
4	15	52.25	26.30	14.95	5.19	234220
4	15	54.15	25.46	8.70	9.78	133345
4	15	54.50	24.85	14.57	5.03	233944
4	15	54.73	19.66	7.89/5.33		135850
4	15	54.95	21.27	10.77/5.95		231901
4	15	54.95	23.63	12.39	4.39	230959
4	15	55.00	23.43	14.12		136096
4	15	56.03	22.05	10.79		133460
4	15	59.45	23.38	7.92		135585
4	15	59.64	23.30	7.46	10.52	233610
4	15	59.90	24.55	12.70	4.96	138973
4	15	60.00	21.87	6.22	10.25	230139
4	15	60.05	21.73	7.86/9.05		136040
4	15	60.09	19.35	9.61/9.12		138482
4	15	60.10	26.28	9.81	11.21	139348
4	15	63.00	22.18	12.03		135559
4	15	64.71	24.16	8.73	10.56	136041
4	15	64.76	20.95	4.90	10.98	135424
4	15	65.00	21.65			238546
4	15	68.88	20.51	8.59	6.23	135595
4	15	73.44	24.93	7.84	7.51	230370
4	15	73.84	23.95	7.38	7.57	230341
4	17	50.00	22.00	11.17		136092
4	17	52.11	31.87	15.77	3.17	133940
4	17	53.70	24.60			236971
4	17	54.07	24.30	12.48	4.98	234019
4	17	54.30	21.21	10.20/5.83		232358
4	17	54.80	19.90			233986
4	17	54.83	24.63	12.30	6.65	230991
4	17	54.85	22.68	7.16	3.20	137535
4	17	54.91	24.89	10.43	8.81	133623
4	17	54.92	25.67	8.61	3.26	133939
4	17	55.00	19.43	13.18		139971
4	17	55.00	23.56	6.61		136941
4	17	55.03	23.51	7.82	8.56	136160
4	17	55.12	28.44	11.65	3.23	232092

Pulley Survey

	B	A	C	E	F	Cargo
Grooves	Bore	O.D.	Width	Depth	Distance-back	
4	17	56.06	23.13	11.91		135520
4	17	56.07	48.99	33.72	29.26	135776
4	17	56.15	24.62	10.15	7.45	135519
4	17	56.47	28.18	13.01	10.59	137958
4	17	57.00				236220
4	17	57.98	30.07	13.08	3.09	232128
4	17	58.10	25.46	12.39	6.10	231798
4	17	58.61				236085
4	17	59.00	23.60	7.20	11.40	234897
4	17	59.64	23.70	16.58	4.07	233536
4	17	59.80	21.67	11.21		138735
4	17	59.93	25.13	12.11	7.66	139666
4	17	59.94	18.82	5.85		135511
4	17	59.95	39.05	25.88		139106
4	17	59.96	22.60	6.99	10.92	139346
4	17	60.00	23.03	15.26		138992
4	17	60.00	25.70			236724
4	17	60.05	21.40	12.78		133404
4	17	60.06	20.43	5.07	5.03	139135
4	17	60.17	42.84	27.22		135530
4/6	17	60.30/62.63	47.73	33.41		133348
4	17	61.17	52.15	36.74		135584
4	17	61.18	21.06	7.82	7.26	133343
4	17	61.27	22.92	7.66	10.68	139324
4	17	61.71	34.03	20.81		136154
4	17	61.93	26.79	13.90	4.81	139317
4	17	61.97	26.13	11.13	5.84	136350
4	17	62.37	30.58	19.28		138600
4	17	62.66	23.79	10.02		135458
4	17	62.87	23.93	12.59	5.02	136454
4	17	63.24	23.60			137844
4	17	64.32	22.29	43.30		232340
4	17	64.91	22.66	6.78	11.08	138395
4	17	65.00	22.50	13.00		138483
4	17	65.42	35.34	19.59	5.96	136161
4	17	66.19	22.79	17.24		232348
4	17	66.43	21.95	9.06		134518
4	17	66.81	23.09	8.15	10.53	232157
4	17	66.91	36.34	8.97	14.73	232078
4	17	67.34	29.78	13.12	1.39	230180
4	17	68.00	20.48	10.83		133624
4	17	69.43	21.21	14.50		134006
5	15	50.23	25.69	15.95	4.06	136081
5	15	52.36	27.87	16.89	4.95	137662
5	15	53.44	28.65	17.47	5.73	132835
5	15	54.77	24.71	11.68		132833
5	15	55.00	31.61	17.10	10.22	231113
5	15	62.63	25.55	13.86		134860
5	15	64.25	29.53	17.65	5.02	133685
5	15	100.00	38.77			136956
5	17	47.58	24.53	16.24		230142
5	17	47.98	33.69	24.32		230977
5	17	48.00	29.17	13.39	4.35	234020
5	17	48.09	29.73	15.16	6.18	137031
5	17	48.52	31.68	14.65	3.38	232125
5	17	48.82	30.98	15.02	3.14	232126
5	17	49.93	36.18	21.34	11.22	137385
5	17	50.05	42.55	28.20		230718
5	17	50.07	27.00	16.94		231973
5	17	50.20	27.10			234697
5	17	52.01	42.47	26.78	4.77	231846
5	17	53.12	30.45	16.30	2.94	232093
5	17	53.21	30.34	13.83	3.44	133942
5	17	53.29	29.94	14.72	6.16	232335
5	17	53.62	27.60	14.55	4.68	234627
5	17	53.70	32.18	22.46	8.58	231857
5	17	53.90	37.50	30.20		236735

	B	A	C	E	F	Cargo
Grooves	Bore	O.D.	Width	Depth	Distance-back	
5	17	53.99	37.31	22.56	4.03	232355
5	17	54.03	30.62	19.22	3.40	139943
5	17	54.39	27.72	16.83	4.99	137655
5	17	54.39	29.66	16.24		232342
5	17	54.66	27.02	19.52		230475
5	17	54.66	30.53	19.43	4.35	136961
5	17	54.71	28.00	11.43	3.26	232087
5	17	54.77	33.63	18.61	11.02	230953
5	17	54.78	37.73	19.08	5.50	138786
5	17	55.00	26.78	16.00		135531
5	17	55.20	23.75	16.55		137734
5	17	55.30	25.10	15.00	5.15	136039
5	17	55.90	34.88	24.19	7.88	139136
5	17	55.92	23.50	8.24		230240
5	17	55.93	26.78	11.45		137255
5	17	55.95	23.19	14.05		131842
5	17	56.00	26.50	17.00		235038
5	17	56.02	30.79	15.25	7.98	232359
5	17	56.04	25.59	11.13	3.80	136349
5	17	56.21	27.44	13.46	4.41	139316
5	17	56.36	23.50	12.92		231284
5	17	56.46	27.40	11.60	3.46	232101
5	17	56.67	32.35	15.02	13.94	136215
5	17	56.92	22.23	19.64		138067
5	17	57.10	36.86	29.82		234365
5	17	58.60	43.70	27.60	3.75	230008
5	17	58.95	27.44	13.02	3.93	139862
5	17	59.50	42.80	26.65	15.50	234625
5	17	59.73	42.43	26.04	18.37	136151
5	17	59.74	26.21	9.94		230958
5	17	59.95	34.07	23.89		230177
5	17	60.00	25.50			234673
5	17	60.06	25.64	12.48	3.31	139863
5	17	60.10	28.56	16.82	6.06	136608
5	17	60.10	35.40	27.73		139074
5	17	60.27	20.33	17.10		137252
5	17	61.43	30.59	13.74	3.23	230533
5	17	61.51	32.12	15.14	3.19	230532
5	17	62.38	24.18	7.49		137253
5	17	62.45	25.82	18.31		139219
5	17	62.87	32.60	17.20	11.43	135743
5	17	62.93	25.71	14.51	5.48	138658
5	17	63.07	28.42	17.32	4.87	136452
5	17	64.32	32.01	13.28		133876
5	17	64.82	26.34	16.34		138281
5	17	64.97	23.38	11.38		231672
5	17	65.71	38.20	22.38	6.11	231635
5	17	66.12	24.70	20.81		135441
5	17	66.25	37.26	19.54	8.48	232337
5	17	67.26	27.32	16.09	1.90	133626
5	17	69.29	26.61	9.06	6.96	136959
5	17	69.58	28.12	16.99	4.32	232347
5	17	69.65	26.87	18.82		232079
5	17	74.50	24.25	16.60		133625
5	20	59.18	37.52	27.01		135740
5	22.23(7/8")	77.18	63.22	26.22	22.10	230826
6	15	54.08	33.01	20.88	6.45	230534
6	15	50.00	31.50	22.00		231283
6	15	54.66	32.44	22.06	4.14	137679
6	17	44.07	29.39	26.54		137251
6	17	47.72	27.02	10.82		137254
6	17	48.05	27.06	20.18		231258
6	17	48.24	33.09	16.00		232140
6	17	48.50	31.50			234540
6	17	48.92	30.32	16.24	3.61	231398
6	17	49.00	29.00			235373
6	17	49.00	30.50	17.00		235228

Pulley Survey

SERPENTINE PULLEY *continued*

Grooves	B Bore	A O.D.	C Width	E Depth	F Distance-back	Cargo
6	17	49.00	31.00			236726
6	17	49.00	33.00	17.00		234994
6	17	49.00	36.97	27.44		231441
6	17	49.33	36.66	21.69		138070
6	17	49.40	31.50			236115
6	17	49.40	37.10	24.45	8.70	234843
6	17	49.42	41.26	25.35	3.79	232333
6	17	49.56	29.75	13.09		231723
6	17	49.60	38.25	32.78		131844
6	17	49.64	40.47	24.16	13.72	137249
6	17	49.96	33.08	18.38	4.67	136601
6	17	50.07	26.53	19.77		231715
6	17	50.12	49.30	34.53		136937
6	17	50.15	29.43	25.59		139310
6	17	50.34	37.34	21.17	3.44	232089
6	17	50.50	31.27	14.90	3.20	232091
6	17	50.59	28.80	13.87	3.30	232097
6	17	50.86	38.83	23.73	12.06	231633
6	17	51.06	27.20	19.98		136471
6	17	51.41	27.93	16.01	3.76	234097
6	17	51.49	56.19	41.78		231634
6	17	51.95	46.40	30.60		231110
6	17	52.00				233849
6	17	52.10	30.30	15.04		137960
6	17	52.11	61.60	45.75		138072
6	17	52.45	30.61	15.53	3.61	232353
6	17	53.00	30.00	23.30		234366
6	17	53.40	29.50	14.38		234626
6	17	53.50	35.80			236599
6	17	54.00	30.00	17.00		235162
6	17	54.01	25.93	15.41		230288
6	17	54.02	39.50	22.23	3.03	136351
6	17	54.25	41.60			231584
6	17	54.30	29.60	17.00		234993
6	17	54.52	28.00	19.25	4.22	233597
6	17	54.54	27.76	18.16	3.92	232352
6	17	54.79	32.44	17.38	4.77	231111
6	17	54.82	42.31	22.63	5.72	139109
6	17	54.93	39.10	27.43	11.66	231428
6	17	54.99	27.04	20.13		135529
6	17	54.99	35.06	19.73	11.07	137963
6	17	55.00	26.50	15.00		233971
6	17	55.02	42.72	28.49	4.12	137701
6	17	55.06	28.59	13.11		230503
6	17	55.07	37.20	23.20	3.12	232099
6	17	55.08	31.75	14.80	3.11	133941
6	17	55.09	27.00	xxxx		234826
6	17	55.09	37.73	33.06		131845
6	17	55.10	31.30	18.54		139452
6	17	55.12	29.55	17.74	5.53	137702
6	17	55.19	32.67	15.53	3.97	232127
6	17	55.22	28.72	18.71		133742
6	17	55.23	30.44	20.15	4.90	230954
6	17	55.23	33.50	18.21	5.85	136153
6	17	55.81	29.09	17.56	7.40	232334
6	17	55.90	27.00			234826
6	17	55.95	28.05	23.58		233850
6	17	56.00	28.90	21.62		233216
6	17	56.01	28.89	13.67		138064
6	17	56.01	29.13	25.44		230956
6	17	56.03	27.27	12.19		139493
6	17	56.04	37.24	22.27		139247
6	17	56.06	29.76	17.93	3.69	136958
6	17	56.08	31.99	13.57	4.41	137516
6	17	56.13	33.45	19.16	10.62	231112
6	17	56.18	36.83	27.47		139932
6	17	56.47	34.08	18.84	10.32	137964

Grooves	B Bore	A O.D.	C Width	E Depth	F Distance-back	Cargo
6	17	56.51	24.91	18.53		138069
6	17	56.60	30.24	14.30	3.52	137056
6	17	56.76	32.15	26.00		137248
6	17	56.91	42.92	26.54	3.19	232088
6	17	57.00	37.22	23.09	3.22	232090
6	17	57.10	46.04	35.27	4.83	137959
6	17	57.11	40.67	26.99		136162
6	17	57.28	26.54	10.64		232349
6	17	57.50	53.64	38.24	3.59	136150
6	17	57.55	26.58	13.38		232039
6	17	57.71	47.47	35.80		135356
6	17	58.05	26.15	15.69		232158
6	17	58.15	31.86	20.38	4.88	232165
6	17	58.15	36.33	20.98	8.74	135560
6	17	58.20	38.85	24.61	3.23	232094
6	17	58.25	27.36	12.44		232156
6	17	58.60	30.25	16.65	3.85	236118
6	17	58.95	27.74	13.39		232134
6	17	59.41	35.60	25.43	5.05	232343
6	17	59.58	29.64	17.96		133870
6	17	59.60	31.16	14.00		234116
6	17	59.61	28.88	12.15		139970
6	17	59.98	31.19	10.13		230720
6	17	60.00	36.35	24.15	3.78	234377
6	17	60.04	32.50	21.40	6.13	135454
6	17	60.15	29.39		6.25	233537
6	17	60.30	33.01	16.28	3.32	133938
6	17	60.53	27.70	22.87		136700
6	17	61.38	36.92	21.39	3.68	232102
6	17	61.45	30.54	14.57	3.35	232100
6	17	61.74	31.85	14.23	3.38	232129
6	17	61.90	46.14	30.16	18.65	138066
6	17	61.91	36.88	26.93	4.71	139412
6	17	61.91	52.31			231511
6	17	62.08	38.51	24.20	5.07	231301
6	17	62.38	33.88	17.72	11.02	233538
6	17	62.40	37.31	21.15	7.21	138463
6	17	62.41	28.04	12.78	3.77	135745
6	17	62.52	29.20	22.41		230290
6	17	62.55	27.90	12.95		232135
6	17	62.55	32.66	16.89	10.05	234155
6	17	62.73	30.78	16.25	3.92	234039
6	17	62.80	30.14	17.51	3.99	232345
6	17	62.89	25.12	18.66		135562
6	17	62.92	29.42	13.29	6.52	138720
6	17	62.92	32.05	20.38	5.08	232163
6	17	63.17	25.51	18.44		136704
6	17	63.46	37.81	25.04		131846
6	17	64.30	31.26	16.40	4.18	233848
6	17	64.50	26.48	8.52		136859
6	17	64.76	25.10	8.68		137554
6	17	64.85	27.41	12.21		135550
6	17	64.97	30.36	13.17		231119
6	17	65.00	26.50	17.00		234602
6	17	65.20	32.50	19.43	5.55	231636
6	17	66.50	31.46	18.14	4.84	232339
6	17	66.52	25.23	14.85		139191
6	17	67.03	37.52	29.20		230121
6	17	67.13	29.46	13.23	2.66	232096
6	17	67.31	37.40	20.45	9.34	138495
6	17	67.49	40.68	32.73	14.2	234026
6	17	68.24	31.79			231332
6	17	69.02	31.35	16.25	7.91	136042
6	17	69.22	27.52	19.80		135426
6	17	70.20	30.94	15.08	3.27	230531
6	17	75.00	26.50			235312
6	17	77.36	27.00			233510



Pulley Survey

SERPENTINE PULLEY *continued*

Grooves	B Bore	A O.D.	C Width	E Depth	F Distance-back	Cargo
7	15	54.94	35.49	24.91		234123
7	15	60.00	35.39	19.78	2.73	132834
7	17	45.63	29.95	14.44		139002
7	17	48.50	37.20	18.54	5.29	139314
7	17	48.60	30.65	21.12		233507
7	17	49.00	37.50			236721
7	17	49.30	35.50	21.35	3.40	236137
7	17	53.57	44.13	28.47		138065
7	17	55.98	27.94	11.05		137605
7	17	56.35	36.77	18.97	3.72	232130
7	17	56.73	29.28	24.48		137095
7	17	60.87	44.41	25.98		138071
7	17	61.39	39.15	25.78	5.20	232336
7	17	64.11	35.59	18.27	4.05	232133
7	17	64.35	34.30	24.37	5.28	232166
7	17	67.11	36.55	17.65	5.25	231632
7	22.23(7/8")	55.04	35.41		3.72	232113
8	17	49.27	35.07	31.14		233940
8	17	50.01	45.68	41.13		135606
8	17	54.27	38.12	27.80	4.81	232155
8	17	55.00	38.50			235081
8	17	57.85	39.41	22.14		232137
8	17	57.96	45.31	30.16	8.54	232095
8	17	61.31	45.30	27.95	3.06	232098
8	17	62.55	39.34	21.84	3.86	232132
8	17	63.11	37.74	26.29	4.55	232164
8	17	64.13	36.38	22.23		232139
8	17	66.79	34.35	20.12		232136
8	17	67.27	45.55	27.53	7.61	232131
8	17	68.22	39.32	22.55		232138
8	17	71.00	36.50	27.29	3.68	231092
8	18/20	60.92	36.87	20.03		136902
8	22.23(7/8")	57.22	38.14	3.93	2.93	232116
8	22.23(7/8")	69.19	42.11	8.03	3.27	232115
8	22.23(7/8")	72.60	44.64	9.73	8.28	232152
8	22.23(7/8")	82.58	37.58	4.09	3.28	232114
9	22.23(7/8")	70.79	40.41	6.32	5.79	232112
9	22.23(7/8")	77.64	66.16	34.58	22.28	232153
10	30	90.12	38.41			234016
11	17	77.00	49.50			234968
12	17	68.85	48.11	39.24		234354

Pulley Survey

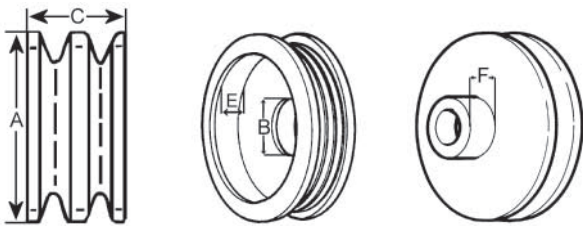

FREE WHEEL PULLEY

TYPE B BELT, 12.5 mm top width

Bore	A O.D.	C Width	E Depth	F Distance-back	Cargo
17	85.50	34.20			235071

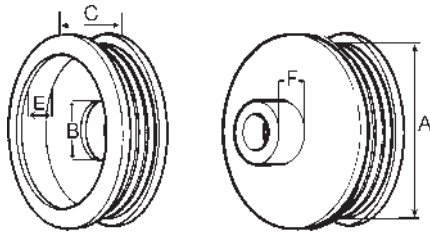

Grooves	Bore	A O.D.	C Width	E Depth	F Distance-back	Cargo
1	17	85.50	34.20			235071
5	M16	49.76	36.31			233847
5	M16	53.85	42.00			236762
5	17	48.80	36.89			233590
5	17	49.66	48.92			230297
5	17	51.89	48.03			230310
5	17	55.00	40.50			237817
5	17	55.76	33.10			230302
5	17	55.80	32.74			230304
5	17	56.00	37.00			230309
5	17	56.08	34.30			230083
5	17	56.82	36.73			138282
5	17	57.70	34.50			237600
5	17	59.67	32.71			230527
6	M14	60.00	38.50			237500
6	17	48.75	37.82			230524
6	17	49.00	34.50			237355
6	17	49.06	32.97			234169
6	17	49.07	32.94			233530
6	17	49.53	38.66			139281
6	17	49.69	38.79			230292
6	17	49.80	35.20			234796
6	17	49.95	35.08			230307
6	17	49.96	39.04			232624
6	17	52.20	39.71			233989
6	17	52.87	32.96			230315
6	17	53.68	35.75			234401
6	17	54.00	37.50			236995
6	17	54.20	38.00			234794
6	17	54.35	33.46			234127
6	17	54.38	31.61			234056
6	17	54.41	32.35			234149
6	17	54.41	34.84			230523
6	17	55.69	32.92			138807

Grooves	Bore	A O.D.	C Width	E Depth	F Distance-back	Cargo
6	17	55.72	37.33			230305
6	17	55.73	41.08			230314
6	17	55.74	37.32			138073
6	17	55.80	37.59			230519
6	17	55.84	40.05			230522
6	17	55.91	34.64			230306
6	17	55.95	40.68			138203
6	17	56.00	32.79			230312
6	17	56.00	35.30			234795
6	17	56.00	37.80			234569
6	17	56.00	43.70			237320
6	17	56.09	41.58			230293
6	17	56.67	33.86			230296
6	17	56.72	35.16			230526
6	17	58.65	41.64			230525
6	17	59.69	36.45			230308
6	17	59.79	34.97			233990
6	17	59.82	39.62			238690
6	17	61.00				235331
6	17	61.50	37.90			230313
6	17	64.97	38.10			230303
6	17	65.00	38.70			234867
6	17	67.82	39.77			230520
6	17	69.20	39.85			234675
7	17	49.00	35.90			238734
7	17	49.68	38.52			230311
7	17	55.50	44.20			234793
7	17	56.00	34.70			237263
7	17	58.00	41.40			236763
7	17	59.01	68.46			233657
7	17	59.59	38.32			230521
7	17	61.00	77.00			235157
7	17	68.00	41.00			237674
8	17	60.00	39.00			238068

Pulley Survey

PULLEY TOOLS



210843

Tool to be used for mounting and dismounting of free wheel Bosch and Magneti Marelli pulleys

210948

As Cargo 210843, but Shaft L. 114 mm.



210873

Tool to be used for mounting and dismounting of Magneti Marelli rubber clutch pulley



210909

Tool to be used for mounting and dismounting of free wheel Valeo pulleys

SPACERS FOR PULLEYS

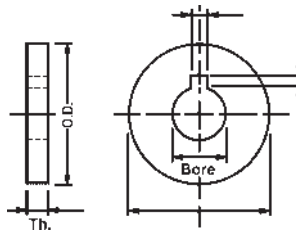

Bore O.D. Th. Key

	Bore	O.D.	Th.	Key
137452	10.6	18.8/21	2.7	
610184	15	21	7.5	
610063 A	15	25	1.5	
610153	15	25	9.2	
230995	15	28	8	
610034 A	15	35	9.2	5
610027 A	15	30	12	5
610033 A	15	35	2.7	5
233341	15	47	14	
234201	15.1	21.1	7.2	
234200	15.1	21.4	9.5	
134273 A	15.5	21.6	5.9	
136238	17	22.0	9.0	
133945 A	17	22.2	5.0	
133948 A	17	22.2	10	
136771	17	23.6	14.5	5
231506	17	23-32.7	12	
235022	17	24.3	4.3	
610032 A	17	25	3.5	5
610031 A	17	25	5.5	5
610026 A	17	25	12	5
610028 A	17	25	16	5
610023 A	17	25	18	5
133949 A	17	25.4	7	
133947 A	17	25.5	3	
137193	17	25.5	5.3	
137194	17	25.5	5.8	
137198	17	25.5	6.5	
136297	17	25.5	8.5	
133946 A	17	25.5	10	
610062 A	17	27	1	
231352	17	27	5.5	
234951	17	27	7	
137196	17	28.5	1	
138774	17	30	4.4	5.1
610030 A	17	30	6.5	5
610024 A	17	30	8	5
610025 A	17	30	12	5
610029 A	17	30	14.5	5
610022 A	17	30	17	5
137200	17	33	5	
610036 A	17	35/25	10.5	5
137195	17	36	3	
139931	17	39	5	
139907	17	44	5	
610061 A	17	45	1	5
610040 A	17	45	2	5
610021 A	17	45	6.5	5
137197	17	46.6	6.1	
610041 A	17.5	35		
610185	20	27	7.8	
231602	20	28.9	7.2	
234363	22	40	6.1/8.1	
232645	22.23	34.7	5	
232749	22.23	35	13.7	

	Bore	O.D.	Th.	Key
232748	22.23	35.5	8	
232750	25.1	35	28	
230822	30	38	13	

Mounting Bushing Survey



	Bore	O.D.	L.
231520	8.4	13.4	15.4
231309	10.1	18.3	15.4
134783	12	19.5	16.2



	Bore	O.D.	L.
231677	8	11	27.5
230220	8	13.05	11
134774 A	8	13.05	20
136461	8	13.5	20
134775 A	8	14	20
137379	8	18	22
234835	8	18.5	21
138088	8	21	20
135211 A	8.2	13.6	20
134278 A	8.5	15.3	15.3
138086	8.5	18.07	20
232405	10	14.5	29.5
139966	10	15	13
134964 A	10	15	18
134277 A	10	16.5	15.3
232738	10	16.5	25.5
233338	10	17	20
137263	10	18.1	20
137400	10	19.03	18.3
230508	10.2	20.2	22
139245	10.2	21	18
137262	10.3	21	22
233214	10.3	21	43
234575	10.5	17.1	16
234265	10.8	21.1	29.6
231569	11.2	14	23
134782	12	19.7	22
137408	12.2	21.1	27
137343	12.3	18.08	22
137461	12.3	18	27
230079	12.3	21.1	22.1
138240	12.5	21.2	25
233276	12.7	19.05	20.64
232737	12.7	22.23	31.27
138241	13.3	21.2	20
139968	13.4	21.3	27



	Bore	O.D.	L.
138451	8	13/16	21
234383	8	15/25	20
139705	8.2	16.6/24.7	16
135281	8.3	15/22	16
135216 A	8.4	14/20	13
137737	8.5	11/19.5	11.1
138243	9	11/20	8
232669	10	15/24	20
135421	10	16.5/22	20.7
234713	10	18.6	26
134676	10.1	16.6/24.7	16
138435	10.2	14/22	17.8
230910	10.2	16.8/21.5	13
233569	10.4	16.5/26	13
234825	10.5	15.5/22.4	18.1
134276 A	10.5	17/22	15
138089	11	14.1/21.5	8.1



	Bore	O.D.	L.
232744	8	14/22	20
232063	8.8	15/21.2	25
139747	8.85	13.5/24.2	25.2
232742	10	16/22	20
232745	10	16/22	21
137497	10	16/24	21
231560	10	18.2/22	15
138245	10.3	17.9/25	26.5
138091	10.35	18/21.9	21.1
138090	10.45	18.05/22	17.5
139592	10.5	18/24.9	26.5
138244	10.6	18.1/21.9	18.1
233277	11.11	15.88/	17.46
233574	M10	18/22	21



	Bore	O.D.	L.
230858	8	10	25.4
135061 A	11.5	14	50



	Bore	O.D.	L.
137575	M8-1.25	18	20
231257	M8-1.25	21	20



	Bore	O.D.	L.
133752	M10-1.25	18.3	23
137575	M10-1.5	21	32



	Bore	O.D.	L.
139246	11.2	13/20	18



	Bore	O.D.	L.
134792	10.5	18/22	16



	Bore	O.D.	L.
136932	10.5	18/22	13

Mounting Bushing Survey

For French Alternators

Steel Bushings

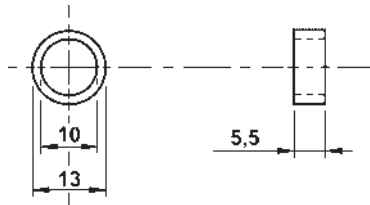

610050 Std pkg 100

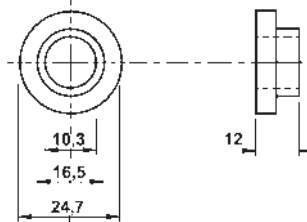

610060 Std pkg 100

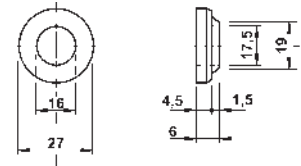

610057 Std pkg 100

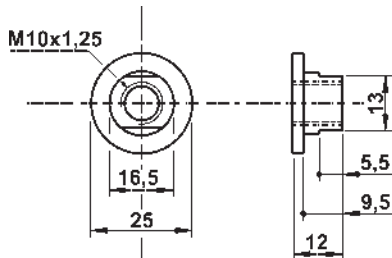

610052 Std pkg 100

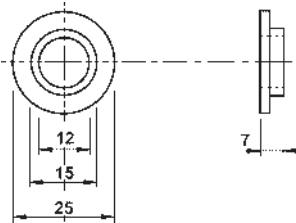

610188 Std pkg 100

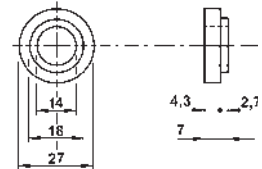

610058 Std pkg 100

Rubber Bushings

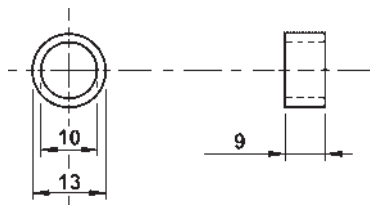

610053 Std pkg 100

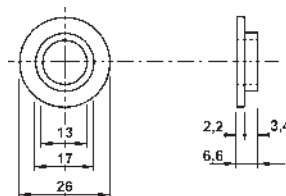

610055 Std pkg 100

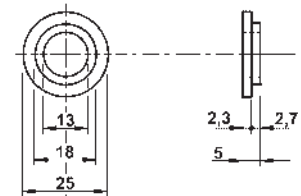

610059 Std pkg 100

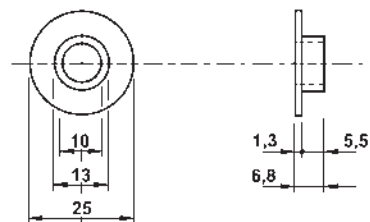

610054 Std pkg 100

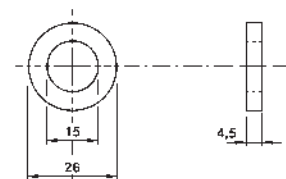

610056 Std pkg 100

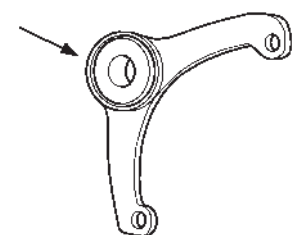

Mounting Bushing Survey

--	--	--



BEARINGS

PART 2
16th Edition



CARGO **Cargo Quality Bearings**

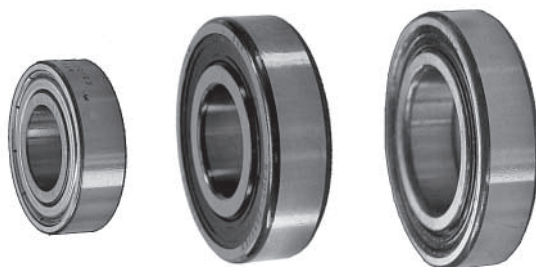

ALL C3

Electric Motor Quality

Tolerances: The bearings are manufactured to close, consistent tolerances. They are manufactured in accordance with P6 or ABEC3, ISO9002, ISO9001, ISO14001, QS9000 & DIN standards.
Noise: 100% test by Anderson measurement.

Components Specifications:

- Cages: Sheet steel (SPCC)
- Shields: SPCC
- Seals: Nitre rubber seal

Excellent temperature Range: Lubrication is Chevron SRI-2 which has an operation temperature range of $\pm 30^{\circ}$ to 175° C.

Std pkg 10	CARGO
6000 2RS1/C3 .. 10 / 26 x 8 mm.....	B140271Z
6000 2Z/C3	B140076Z
6001 2RS1/C3 .. 12 / 28 x 8 mm.....	B140077Z
6001 2Z/C3	B140078Z
6002 2RS1/C3 .. 15 / 32 x 9 mm.....	B140272Z
6002 2Z/C3	B140284Z
6003 2RS1/C3 .. 17 / 35 x 10 mm	B140273Z
6003 2Z/C3	B140285Z
6004 2RS1/C3 .. 20 / 42 x 12 mm	B140223Z
6004 2Z/C3	B140286Z
6200 2RS1/C3 .. 10 / 30 x 9 mm.....	B140079Z
6200 2Z/C3	B140080Z
6201 2RS1/C3 .. 12 / 32 x 10 mm	B140081Z
6201 2Z/C3	B140082Z
6202 2RS1/C3 .. 15 / 35 x 11 mm	B140084Z
6202 2Z/C3	B140086Z
6203 2RS1/C3 .. 17 / 40 x 12 mm	B140087Z
6203 2Z/C3	B140088Z
6204 2RS1/C3 .. 20 / 47 x 14 mm	B140218Z
6204 2Z/C3	B140159Z
6205 2RS1/C3 .. 25 / 52 x 15 mm	B140219Z
6205 2Z/C3	B140089Z
6206 2RS1/C3 .. 30 / 62 x 16 mm	B140220Z
6206 2Z/C3	B140288Z
6300 2RS1/C3 .. 10 / 35 x 11 mm	B140635Z
6301 2RS1/C3 .. 12 / 37 x 12 mm	B140277Z
6302 2RS1/C3 .. 15 / 42 x 13 mm	B140091Z
6302 2Z/C3	B140092Z
6303 2RS1/C3 .. 17 / 47 x 14 mm	B140093Z
6303 2Z/C3	B140094Z
6304 2RS1/C3 .. 20 / 52 x 15 mm	B140278Z
6304 2Z/C3	B140175Z
6305 2RS1/C3 .. 25 / 62 x 17 mm	B140279Z
6305 2Z/C3	B140292Z

FAG
FAG Bearings
SINGLE PACKED

		CARGO	Std pkg
607 2RS/C3	7 / 19 x 6	141057	10
607 2Z/C3	7 / 19 x 6	140296 A	10
608 2RS1/C3	8 / 22 x 7	140222 A	10
608 2Z/C3	8 / 22 x 7	140297	10
609 2RS/C3	9 / 24 x 7	141058	10
609 2Z/C3	9 / 24 x 7	140298	10
625 2RS1/C3	5 / 16 x 5	140459	10
625 2Z/C3	5 / 16 x 5	140458	10
626 2RS1/C3	6 / 19 x 6	140523 A	10
626 2Z/C3	6 / 19 x 6	140299	10
627 2RS/C3	7 / 22 x 7	141059	10
627 2Z/C3	7 / 22 x 7	140300 A	10
629 2RS1/C3	9 / 26 x 8	140893	10
629 2Z/C3	9 / 26 x 8	140301 A	10
6000 2RS1/C3	10 / 26 x 8	140271	10
6000 2Z/C3	10 / 26 x 8	140076	10
6001 2RS1/C3	12 / 28 x 8	140077	10
6001 2Z/C3	12 / 28 x 8	140078	10
6002 2RS1/C3	15 / 32 x 9	140272 A	10
6002 2Z/C3	15 / 32 x 9	140284	10
6003 2RS1/C3	17 / 35 x 10	140273 A	10
6003 2Z/C3	17 / 35 x 10	140285	10
6004 2RS1/C3	20 / 42 x 12	140223 A	10
6004 2Z/C3	20 / 42 x 12	140286	10
6005 2RS1/C3	25 / 47 x 12	140274	10
6005 2Z/C3	25 / 47 x 12	140287	10
6006 2RS1/C3	30 / 55 x 13	140283	10
6006 2ZR	30 / 55 x 13	140886	1
6007 2RS1/C3	35 / 62 x 14	140631	1
6007 2ZR	35 / 62 x 14	140887	1
6008 2RS1/C3	40 / 68 x 15	140632	1
6008 2ZR	40 / 68 x 15	140888	1
6009 2RS1/C3	45 / 75 x 16	140633	1
6009 2ZR	45 / 75 x 16	140889	1
6010 2RS1/C3	50 / 80 x 16	140634	1
6011 2RS1/C3	55 / 90 x 18	140891	1
6200 2RS1/C3	10 / 30 x 9	140079	10
6200 2Z/C3	10 / 30 x 9	140080	10
6201 2RS1/C3	12 / 32 x 10	140081	10
6201 2Z/C3	12 / 32 x 10	140082	10
6202 2RS1/C3	15 / 35 x 11	140084	10
6202 2Z/C3	15 / 35 x 11	140086	10
6203 2RS1/C3	17 / 40 x 12	140087	10
6203 2Z/C3	17 / 40 x 12	140088	10
6204 2RS1/C3	20 / 47 x 14	140218	10
6204 2Z/C3	20 / 47 x 14	140159	10
6205 2RS1/C3	25 / 52 x 15	140219	10
6205 2Z/C3	25 / 52 x 15	140089	10
6206 2RS1/C3	30 / 62 x 16	140220	10
6206 2Z/C3	30 / 62 x 16	140288	10
6207 2RS1/C3	35 / 72 x 17	140275	10
6207 2Z/C3	35 / 72 x 17	140289	10
6208 2RS1/C3	40 / 80 x 18	140276	1
6208 2Z/C3	40 / 80 x 18	140290	1
6209 2RS1/C3	45 / 85 x 19	140636	1
6210 2RS1/C3	50 / 90 x 20	140637	1
6211 2RS1/C3	55 / 100 x 21	140638	1
6212 2RS1/C3	60 / 110 x 22	140291	1
6213 2RS1/C3	65 / 120 x 23	140639	1
6214 2RS1/C3	70 / 125 x 24	140640	1
6300 2RS1/C3	10 / 35 x 11	140635	1

		CARGO	Std pkg
6301 2RS1/C3	12 / 37 x 12	140277	10
6302 2RS1/C3	15 / 42 x 13	140091	10
6302 2Z/C3	15 / 42 x 13	140092	10
6303 2RS1/C3	17 / 47 x 14	140093 A	10
6303 2Z/C3	17 / 47 x 14	140094	10
6304 2RS1/C3	20 / 52 x 15	140278	10
6304 2Z/C3	20 / 52 x 15	140175	10
6305 2RS1/C3	25 / 62 x 17	140279	5
6305/17 2RS1/C3	17 / 62 x 17	140401	5
6305 2Z/C3	25 / 62 x 17	140292	5
6306 2RS1/C3	30 / 72 x 19	140280	5
6306 2Z/C3	30 / 72 x 19	140293	5
6307 2RS1/C3	35 / 80 x 21	140281	1
6307 2Z/C3	35 / 80 x 21	140294	1
6308 2RS1/C3	40 / 90 x 23	140282	1
6308 2Z/C3	40 / 90 x 23	140295	1
6309 2RS1/C3	45 / 100 x 25	140302	1
6310 2RS1/C3	50 / 110 x 27	140303	1
6311 2RS1/C3	55 / 120 x 29	140304	1
6312 2RS1/C3	60 / 130 x 31	140641	1
6313 2RS1/C3	65 / 140 x 33	140642	1
6314 2RS1/C3	70 / 150 x 35	140643	1
6403 2RS1/C3	17 / 62 x 17	140878	5
6403 /C3	17 / 62 x 17	140394	5
16009	45 / 75 x 10	140649	1
62202 2RS1/C3	15 / 35 x 14	140265 A	5
62203 2RS1/C3	17 / 40 x 16	140900	5
62302 2RS1/C3	15 / 42 x 17	140936	10
62303 2RS1/C3	17 / 47 x 19	140266 A	10
62304 2RS1	20 / 52 x 21	140442 A	10
62305 2RS1	25 / 62 x 24	140879	5
63001 2Z/C3	12 / 28 x 12	140116 A	10
CRL 10 A	31.75/69.85 x 17.46	140445	5
N 306 ECP	30 / 72 x 19	140446	5
NU 202 ECP	15 / 35 x 11	140515 A	1
NU 204 ECP/C3	20 / 47 x 14	140816	10
NU 205 ECP	25 / 52 x 15	140516 A	10
NU 306 ECP	30 / 72 x 19	141044	5

MISCELLANEOUS TYPES

		CARGO	Std pkg
628 2Z/C3	8 / 24 x 8	140848	10
3205 2RS1	25 / 52 x 20.6	140882	1
3305 2RS1	25 / 62 x 25.4	140883	1
6306 2RS1	30 / 72 x 30.2	140884	1
6902 2RS	15 / 28 x 7	140224 A	10
6903 2RS	17 / 30 x 7	140225 A	10
6904 2RS	20 / 37 x 9	140226 A	10
6905 2RS	25 / 42 x 9	140227 A	10
6906 2RS1	30 / 47 x 9	140868	5
62000 2RS	10 / 26 x 10	140784	10
62201 2RS1/C3	12 / 32 x 14	140105 A	10
62306 X1LLUA/C3	30 / 72 x 27	140707	5
BB1-3036	16.96 / 34.97 x 9.94	141071	10
TM-623/22 LLUA	22 / 56 x 21	140917	1

KBC KBC Quality Bearings

ALL C3

Electric Motor Quality

Tolerances: The bearings are manufactured to close, consistent tolerances. They are manufactured in accordance with KSB2013 standards which are equivalent to ANSI/AFBMA, ISO, DIN and JIS Standards.

Components Specifications:

Rings & rolling elements: High chromium bearing steel STB2 equivalent to AISI E52100 & JIS SUJ2

Cages: Low carbon pressed steel, Shields: Low carbon steel, Seals: Buna N (Neoprene)

Excellent temperature Range: Lubrication is Chevron SRI-2 which has an operation temperature range of $\pm 29^{\circ}$ to 176° C.

SINGLE PACKED		CARGO	Std pkg	CARGO		Std pkg	
608 2RS1	8 / 22 x 7 mm	B140222P	10	6214 2RS1/C3 ..	70 / 125 x 24 mm ...	B140640P	6
6000 2RS1/C3 ..	10 / 26 x 8 mm	B140271P A	295	6300 2RS1/C3 ..	10 / 35 x 11 mm	B140635P A	240
6000 2Z/C3	10 / 26 x 8 mm	B140076P	295	6301 2RS1/C3 ..	12 / 37 x 12 mm	B140277P A	240
6001 2RS1/C3 ..	12 / 28 x 8 mm	B140077P A	295	6302 2RS1/C3 ..	15 / 42 x 13 mm	B140091P A	150
6001 2Z/C3	12 / 28 x 8 mm	B140078P	295	6302 2Z/C3	15 / 42 x 13 mm	B140092P	150
6002 2RS1/C3 ..	15 / 32 x 9 mm	B140272P A	295	6303 2RS1/C3 ..	17 / 47 x 14 mm	B140093P A	150
6002 2Z/C3	15 / 32 x 9 mm	B140284P	295	6303 2Z/C3	17 / 47 x 14 mm	B140094P	150
6003	17 / 35 x 10 mm	140796	10	6304 2RS1/C3 ..	20 / 52 x 15 mm	B140278P A	80
6003 2RS1/C3 ..	17 / 35 x 10 mm	B140273P A	240	6304 2Z/C3	20 / 52 x 15 mm	B140175P	80
6003 2Z/C3	17 / 35 x 10 mm	B140285P	240	6305 2RS1/C3 ..	25 / 62 x 17 mm	B140279P	60
6004	20 / 42 x 12 mm	140795	10	6305 2Z/C3	25 / 62 x 17 mm	B140292P	60
6004 2RS1/C3 ..	20 / 42 x 12 mm	B140223P A	150	6306 /C3	30 / 72 x 19 mm	B140644P	40
6004 2Z/C3	20 / 42 x 12 mm	B140286P	150	6306 2RS1/C3 ..	30 / 72 x 19 mm	B140280P	40
6005 2RS1/C3 ..	25 / 47 x 12 mm	B140274P A	150	6306 2Z/C3	30 / 72 x 19 mm	B140293P	40
6005 2Z/C3	25 / 47 x 12 mm	B140287P	150	6307 2RS1/C3 ..	35 / 80 x 21 mm	B140281P	30
6006 2RS1/C3 ..	30 / 55 x 13 mm	B140283P	80	6307 2Z/C3	35 / 80 x 21 mm	B140294P	30
6006 2Z/C3	30 / 55 x 13 mm	B140886P	80	6308 2RS1/C3 ..	40 / 90 x 23 mm	B140282P	24
6007 2RS1/C3 ..	35 / 62 x 14 mm	B140631P	60	6308 2Z/C3	40 / 90 x 23 mm	B140295P	24
6007 2Z/C3	30 / 62 x 14 mm	B140887P	60	6309 2RS1/C3 ..	45 / 100 x 25 mm ...	B140302P	16
6008 2RS1/C3 ..	40 / 68 x 15 mm	B140632P	55	6310 2RS1/C3 ..	50 / 110 x 27 mm ...	B140303P	15
6008 2Z/C3	40 / 68 x 15 mm	B140888P	55	6310 2Z/C3	50 / 110 x 27 mm ...	B140894P	15
6009 2RS1/C3 ..	45 / 75 x 16 mm	B140633P	55	6311 2RS1/C3 ..	55 / 120 x 29 mm ...	B140304P	6
6009 2Z/C3	45 / 75 x 16 mm	B140889P	55	6312 2RS1/C3 ..	60 / 130 x 31 mm ...	B140641P	6
6010 2RS1/C3 ..	50 / 80 x 16 mm	B140634P	40	6313 2RS1/C3 ..	65 / 140 x 33 mm ...	B140642P	6
6010 2Z/C3	50 / 80 x 16 mm	B140890P	40	6314 2RS1/C3 ..	70 / 150 x 35 mm ...	B140643P	6
6011 2RS1/C3 ..	55 / 90 x 18 mm	B140891P	30	BULK PACKED			
6011 2Z/C3	55 / 90 x 18 mm	B140892P	30	Industrial Pack for Rebuilders			
6200 2RS1/C3 ..	10 / 30 x 9 mm	B140079P A	295		CARGO	Min. sup.	Ind. pkg
6200 2Z/C3	10 / 30 x 9 mm	B140080P	295	608 2RS1	B140222	160	1280
6201 2RS1/C3 ..	12 / 32 x 10 mm	B140081P A	295	6000 2RS1/C3	B140271	25	750
6201 2Z/C3	12 / 32 x 10 mm	B140082P	295	6002 2RS1/C3	B140272	25	525
6202 2RS1/C3 ..	15 / 35 x 11 mm	B140084P A	240	6003 2RS1/C3	B140273	20	360
6202 2Z/C3	15 / 35 x 11 mm	B140086P	240	6004 2RS1/C3	B140223	15	210
6203	17 / 40 x 12 mm	140794	10	6200 2RS1/C3	B140079	25	450
6203 2RS1/C3 ..	17 / 40 x 12 mm	B140087P A	150	6200 2Z/C3	B140080	25	450
6203 2Z/C3	17 / 40 x 12 mm	B140088P A	150	6201 2RS1/C3	B140081	20	420
6204	20 / 47 x 14 mm	140874	10	6201 2Z/C3	B140082	20	420
6204 2RS1/C3 ..	20 / 47 x 14 mm	B140218P A	150	6202 2RS1/C3	B140084	20	340
6204 2Z/C3	20 / 47 x 14 mm	B140159P	150	6202 2Z/C3	B140086	20	340
6205 2RS1/C3 ..	25 / 52 x 15 mm	B140219P A	80	6203 2RS1/C3	B140087	15	240
6205 2Z/C3	25 / 52 x 15 mm	B140089P	80	6203 2Z/C3	B140088	15	240
6206 2RS1/C3 ..	30 / 62 x 16 mm	B140220P A	60	6205 2RS1/C3	B140219	15	120
6206 2Z/C3	30 / 62 x 16 mm	B140288P	60	6302 2RS1/C3	B140091	15	180
6207 2RS1/C3 ..	35 / 72 x 17 mm	B140275P	40	6302 2Z/C3	B140092	15	180
6207 2Z/C3	35 / 72 x 17 mm	B140289P	40	6303 2RS1/C3	B140093	15	135
6208 2RS1/C3 ..	40 / 80 x 18 mm	B140276P	35	6303 2Z/C3	B140094	15	135
6208 2Z/C3	40 / 80 x 18 mm	B140290P	35	6305 2Z/C3	B140292	10	60
6209 2RS1/C3 ..	45 / 85 x 19 mm	B140636P	30	6311 2RS1/C3	B140304	1	6
6210 2RS1/C3 ..	50 / 90 x 20 mm	B140637P	30				
6211 2RS1/C3 ..	55 / 100 x 21 mm ...	B140638P	24				
6212 2RS1/C3 ..	60 / 110 x 22 mm ...	B140291P	20				

Special Bearings
BOSCH

140105 Std pkg 14 **A**
Replacing 1900 905 282, 62201LRSX
Servicing 0120 489 643, -921
 12/32 x 14 mm



140116 Std pkg 10 **A**
Replacing 394737A, 1120 900 002,
 9923 271
 12/28 x 12 mm



140176 Std pkg 10 **A**
Replacing 365740 BB1B, 1120 900 008,
 1120 900 010
 17/62 x 17.5 mm



140263 Std pkg 10 **A**
Replacing 1120 905 012, 363226C
Servicing 0120 469 745, -746
 17/52 x 17 mm



140442 Std pkg 10 **A**
Replacing 62304 2RS1
 20/52 x 21 mm



140569 Std pkg 6 **A**
Replacing 1120 905 005,
 TM-62304 LLUA/17
 17/52 x 21 mm

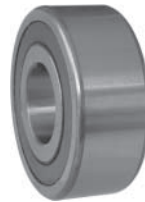

140707
Replacing 2120 905 000, 62306X1 LLUA
Servicing 0120 689 519, -520, -521, -522,
 -523, -526, -528
 30/72 x 27 mm



140879 Std pkg 5
Replacing 1120 905 007, -043
Servicing 0122 469 002, -005
 25/62 x 24 mm



140917
Replacing 1120 905 035, TM-623-22LLUC3
Servicing 0120 468 028, -054
 22/56 x 21 mm



140957 Std pkg 8
Replacing 1120 905 097
 17/62 x 20 mm



141232 
Replacing 1120 905 510
 17/52 x 17 mm
 For use in alternators w/ Free wheel



141233 
Replacing 1120 905 502, F00M 990 410
 17/47 x 14 mm
 For use in alternators w/ Free wheel

Special Bearings

DELCO EUR.

DELCO US

FORD US

142021

Servicing 39 MT
28/58 x 16 mm
W/2 grooves inside bore



140784

Replacing 10473711
Servicing CS 130
10/26 x 10 mm
S.R.E.



140588 Std pkg 5 **A**

Replacing SC 0081 LHIA
10/27 x 14 mm
W/ 2 teflon tolerance rings
S.R.E.



141002

Replacing 1989711, 10474532
Servicing CS 144
10/26 x 8 mm
W/ 2 teflon tolerance rings, S.R.E.

140783 Std pkg 6

Servicing 3G-Series
17/47 x 24 mm
D.E.



142021

Servicing 39 MT
28/58 x 16 mm
W/2 grooves inside bore



141002

Servicing 3G-Series
10/26 x 8 mm
W/ 2 teflon tolerance rings, S.R.E.



141026

Servicing 6G-Series
10/27 x 11 mm
S.R.E.

Special Bearings

141107
Replacing F50U 10A304 AA
Servicing 4G series
 17/40 x 12 mm
 W/ 2 teflon tolerance rings

HITACHI

140222 Std pkg 10 **A**
Replacing 2114-15502, 23319-4900
Servicing Gear reduction starters
 8/22 x 7 mm



140227 Std pkg 10 **A**
Replacing 2130-3302, 23441-J5500
Servicing Gear reduction starters
 25/42 x 9 mm



140223 Std pkg 10 **A**
Replacing 2114-45502, 23363-4900
Servicing Gear reduction starters
 20/42 x 12 mm



140233 Std pkg 5 **A**
Replacing 6900 BPL
Servicing I.C. alternators w/ internal fan
 10/23 x 11 mm
 W/ snap ring



140225 Std pkg 10 **A**
Replacing 2114-25502, 23338-M4900
Servicing Gear reduction starters
 17/30 x 7 mm



140235 Std pkg 5 **A**
Replacing B10-50D
Servicing I.C. alternators w/ internal fan
 10/27 x 11 mm
 W/ snap ring



140226 Std pkg 10 **A**
Replacing 2114-35502, 23358-M4900
Servicing Gear reduction starters
 20/37 x 9 mm



140432 Std pkg 10 **A**
Replacing 23129-16A00, 6202 NC
 15/35 x 11 mm
 W/ snap ring

Special Bearings



140434 Std pkg 10 **A**
Replacing 23129-05E06, 6202 NCD,
 B 15-69
 15/35 x 13 mm
 W/ snap ring



141103
Servicing LR160-727, LR165-708C,
 LR170-745, -748, -757B, -758, LR180-725E
 10/27 x 11 mm
 W/ 2 teflon tolerance rings

LEECE NEVILLE



140882
Replacing 32054, 36686, 4090
 25/52 x 20.6 mm
 S.R.E.



140989 Std pkg 5
Replacing 6201 NCD, -NCDP
 12/32 x 13 mm
 W/ snap ring



140883
Replacing 35624
 25/62 x 25.4 mm
 D.E.



141012
Replacing 6202 LLBC3
 15/35 x 11 mm
 W/ 2 teflon tolerance rings



140884
Replacing 29662, 74091
 30/72 x 30.2 mm
 D.E.

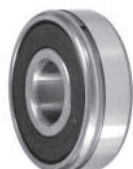

141062 Std pkg 5
Replacing 6302 NC
 15/42 x 13 mm
 W/ snap ring

Special Bearings
LUCAS

140106 Std pkg 10 **A**
Replacing SE 5 KDD
Servicing C40T
 1/2"/1 1/8" x 5/16"



141108
Replacing 31539-66
Servicing Harley Davidson starter (D.E.)
 (R12)
 19.1/41.3 x 11.1 mm
 (0.75"/1.625" x 0.4375")

MAGNETI MARELLI

140116 Std pkg 10 **A**
Replacing 9923271, 394737A, 63001-2Z
 12/28 x 12 mm



140265 Std pkg 5 **A**
Replacing 62202 2RS
Servicing 633 009 05
 15/30 x 14 mm



140266 Std pkg 10 **A**
Replacing 24940240, 62303-2RS1
 17/47 x 19 mm



141071 Std pkg 10
Replacing BB1-3036 SKF
 16.96/34.97 x 9.94 mm

MANDO MELROE

140232 Std pkg 10 **A**
Replacing BB-79D
Servicing I.C. alternators w/ internal fan
 8/23 x 11 mm
 W/ snap ring

Special Bearings

MITSUBISHI



140224 Std pkg 26 **A**

Replacing 6902 2RS1
Servicing Honda
Gear reduction starters
15/28 x 7 mm



140411 Std pkg 8

Replacing S930P 18470, B 15-83D,
B 15-84DW
15/47 x 18 mm



140420 Std pkg 10 **A**

Replacing S930P 63070, B15-86D
15/47 x 14 mm



140231 Std pkg 5 **A**

Replacing S930P17170
Servicing I.C. alternators w/ internal fan
8/22 x 11 mm
W/ snap ring



140412 Std pkg 10 **A**

Servicing Gear reduction starters
19/37 x 9 mm
W/ bushing



140432 Std pkg 10 **A**

Replacing 6202 2RSNR, -VVNCXCM
15/35 x 11 mm
W/ snap ring



140232 Std pkg 10 **A**

Replacing S930P17970, B8-79D
Servicing I.C. alternators w/ internal fan
8/23 x 11 mm
W/ snap ring



140417 Std pkg 10 **A**

Replacing S930P 61201, S210-24-523
12/32 x 10 mm
W/ snap ring



140434 Std pkg 10 **A**

Replacing 6202 NCD
15/35 x 13 mm
W/ snap ring



140234 Std pkg 10 **A**

Replacing S930P18570, B8-85D
Servicing I.C. alternators w/ internal fan
8/23 x 14 mm
W/ snap ring



140419 Std pkg 5 **A**

Replacing S930P 63670, N336 18W36,
SL8AD5LHI
8/23 x 14 mm
W/ 2 teflon tolerance rings



140588 Std pkg 5 **A**

Replacing SC 0081 LHIA
10/27 x 14 mm
W/ 2 teflon tolerance rings
S.R.E.

Special Bearings

140589 Std pkg 8 **A**
Replacing B17-107D
 17/47 x 18 mm



141009
Replacing M690X00571, ME701484
Servicing M8T55171, -80071, -A, -80171, -85071, -A, -85271, -87171, -87271
 Bearing: 20/42 x 12 mm
 Oil seal: 20 x 38.2 x 2.4 mm



141181
Replacing M410X13671, MD700540
Servicing M3T56071, -56072, -56074, -56082, -56084, -56085
 Bearing: 18.7/47.1 x 14 mm
 Bearing kit



140754 Std pkg 5
Replacing B17-116DG
 17/52 x 18 mm



141012
Replacing 6202 LLBC3
 15/35 x 11 mm
 W/ 2 teflon tolerance rings



141236 
Replacing 5930P35670, -80870
 15/42 x 13 mm
 W/ 2 teflon tolerance rings



140783 Std pkg 6
Replacing S930P64870, MD618338
Servicing A4T01493, -01793, -01893
 17/47 x 24 mm
 D.E.



141038
Replacing M410X14171
Servicing M2T57871, -57881, -61771, -67881, -67882, -67883, -67884, -67981
 Bearing w/ bushing: 18.8 / 42 x 12 mm
 Oil seal: 18.80 x 30 x 4.42 mm
 Bearing set



141254 
Replacing M690X 00471, ME701433
Servicing M3T56 089, M8T60 071, -072, -089, -171, -173, -174, -271, -428, -429
 20/47 x 14 mm
 W/ 2 inner grooves
 Oil seal 20 x 38.1 x 2.4 mm



140868 Std pkg 16
Servicing M1T60081, -60181, -60185, -60281, -60285, -60581, -61181
 30/47 x 9 mm



141166
Replacing 6906DW
Servicing M0T60081, -60181, M1T60281, -60285, -60381
 30/47 x 9 mm
 W/ 2 grooves in bore



141255 
Replacing M690X 00671, ME701507
Servicing M8T55 471, M8T60 073, -371, -372, -373, -389, -471, -489, -571, -771
 20/47 x 14 mm
 W/ 2 inner grooves
 Oil seal 20 x 38.2 x 4.3 mm

Special Bearings

MOTOROLA US



141110
Replacing 11-39, 111-39
Servicing 8SA-, 12SA-Series (W6203)
 17/40 x 17.5 mm

NIPPONDENSO



140222 Std pkg 10 **A**
Replacing 949100-1360, 608 2RS
Servicing Gear reduction starters
 8/22 x 7 mm

142005 **N**
Replacing 6805-2RS
Servicing M9T60471, -60672, -61171
 37/25 x 7 mm

142021 **N**
Servicing 39 MT
 28/58 x 16 mm
 W/2 grooves inside bore



140223 Std pkg 10 **A**
Replacing 23363-M4900, 6004 2RS
Servicing Gear reduction starters
 20/42 x 12 mm



140236 **A**
Replacing 949100-2140
 12/35 x 18 mm



140237 Std pkg 8 **A**
Replacing 949100-2790
Servicing I.C. alternators w/ internal fan
 15/35 x 13 mm

Special Bearings

140239 Std pkg 10 **A**
Replacing 949100-3360
Servicing I.C. alternators w/ internal fan
 15/46 x 14 mm



140461 Std pkg 12 **A**
Replacing 949100-3480
Servicing Alternators w/ internal fan
 15/38 x 19 mm



141018
Replacing 949100-3440
 15/43 x 24 mm



140441 Std pkg 16 **A** **Replacing**
 949100-3170, 90099-10154
 15/32 x 11 mm

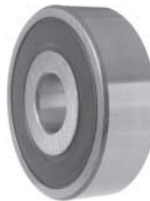

140462 Std pkg 8 **A**
Replacing 949100-3820
Servicing Alternators w/ internal fan
 15/52 x 16 mm



140443 Std pkg 10 **A**
Replacing 949100-3190, 90099-10152
 15/43 x 13 mm



140630 **A**
Replacing 949100-3270
 15/36 x 18 mm



140460 Std pkg 8 **A**
Replacing 949100-3330
Servicing Alternators w/ internal fan
 17/52 x 16 mm



140960 Std pkg 10
Replacing 949100-4840
 8/28 x 9 mm

Special Bearings

PARIS RHONE/VALEO



140263 Std pkg 10 **A**
Replacing 592905, -36, 593674
Servicing A14Vi...
 17/52 x 17 mm



140401 Std pkg 5 **A**
Replacing 102130
 17/62 x 17 mm



140441 Std pkg 16 **A**
Replacing 593690
Servicing A11Vi... , A13Vi...
 15/32 x 11 mm

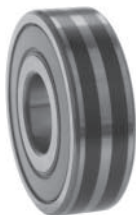

140839 Std pkg 10
Replacing 593691, 6203 LHA
Servicing A13Vi...
 15/40 x 12 mm

POONG SUNG



141199
Servicing 02131-9040
 17/52 x 15 mm
 6304 DR bearing

Japanese Special Bearings Cross Reference List

	CARGO		Std pkg
CROYDON			
M152112	140495	15/21 × 12 Needle bearing	5
KOYO			
319	140443 A	15/43 × 13	10
333	140460 A	17/52 × 16	1
336	140239 A	15/46 × 14	5
348	140461 A	15/38 × 19	5
883 382	140462 A	15/52 × 16	1
6201 RD	140236 A	12/35 × 18	1
949100-279	140237 A	15/35 × 13	10
949100-317	140441 A	15/32 × 11	10
NSK			
6201V	140417 A	15/47 × 18 w/snap ring	10
6202V	140432 A	15/35 × 11 w/snap ring	10
6902V	140224 A	15/28 × 7	10
B8-74D	140231 A	8/22 × 11 w/snap ring	5
B8-79D	140232 A	8/23 × 11 w/snap ring	10
B8-85D	140234 A	8/23 × 14 w/snap ring	10
B10-46D	140233 A	10/23 × 11 w/snap ring	5
B10-50D	140235 A	10/27 × 11 w/snap ring	5
B12-57T	140989	12/32 × 13 w/snap ring	5
B15-69D	140434 A	15/35 × 13 w/snap ring	10
B15-83D	140441 A	15/32 × 11	10
B15-86D	140420 A	15/47 × 14	10
B15-94DW3 (823)	140441 A	15/32 × 11	10
B17-99DDW	140263 A	17/52 × 17	10
B17-107D	140589 A	17/47 × 18	1
B17-116DG	140754	17/52 × 18	5
B17-127DG	140957	17/62 × 20	1
2B17-4DG	140783	17/47 × 24	1
NSK TORR			
FJ2212	140381 A	22/28 × 12 Needle bearing	1
NTN			
808 A05 LH1	140419 A	8/23 × 14 w/snap ring	5
6303 LH	140420 A	15/47 × 14	10
SC0081LHIA	140588 A	10/27 × 14	5
SC0352LLUA CLW	140263 A	17/52 × 17	10
SC8AD5LHI	140419 A	8/23 × 14 w/snap ring	5

Bearing Tolerance Rings

- Repair worn bearing housings, even those you used to throw away.
- Tolerance rings are compression sleeves specially designed to mount ball bearings securely with only a light press-fit. Each corrugation in a tolerance ring acts as an individual spring exerting a uniform compressive force to give a firm grip and prevent outer-race rotation.

Std pkg 10



CARGO	Bearing application	Recommended housing bore
141116	30.00 x .9.00 mm	31.92 - 31.98 mm (1.257"-1.259")
140243 A	32.00 x 10.00 mm	33.88 - 33.97 mm (1.334"-1.337")
140244 A	35.00 x 10.00 mm	36.88 - 36.97 mm (1.452"-1.456")
140245 A	40.00 x 12.00 mm	41.88 - 41.97 mm (1.649"-1.652")
140246 A	47.00 x 14.00 mm	48.88 - 48.97 mm (1.924"-1.928")
140247 A	52.00 x 15.00 mm	54.34 - 54.46 mm (2.139"-2.144")
140616 A	26.00 x .8.00 mm	27.88 - 27.97 mm (1.099"-1.101")
140718 A	28.00 x 10.00 mm	29.75 - 29.98 mm (1.171"-1.180")
140719 A	28.00 x 12.00 mm	29.75 - 29.98 mm (1.171"-1.180")
140720 A	32.00 x 14.00 mm	33.67 - 33.89 mm (1.326"-1.334")
140721 A	35.00 x 14.00 mm	36.75 - 36.98 mm (1.447"-1.456")
140877	40.00 x 11.00 mm	41.75 - 41.98 mm (1.644"-1.653")
140910	47.00 x 12.00 mm	48.75 - 48.98 mm (1.919"-1.928")
140913	62.00 x 17.00 mm	64.35 - 64.47 mm (2.533"-2.538")



140608 A	23/25 x 11 mm, Cargo 140233 (6900)
140739 A	26/28 x 8 mm
140609 A	27/29 x 11 mm, Cargo 140235 (B 10-50)
140131 A	28/30 x 10 mm, Cargo 140077, 140078 (6001)
140703 A	28/30 x 14.8 mm
1405246	28/35 x 13 mm
140700 A	30/34 x 15 mm
140701 A	30/34 x 12 mm
141066	32/35 x 9 mm
140132 A	32/35 x 11.5 mm, Cargo 140081, 140082 (6201)
140702 A	32/35 x 15.5 mm
140133 A	32/36 x 13 mm, Cargo 140081, 140082 (6201)
140504 A	32/36 x 16 mm, Cargo 140105 (62201)
140651 A	32/37 x 12.5 mm, Cargo 140081, 140082
140699 A	35/38 x 15.5 mm
140722 A	35/38 x 10 mm
141034	40/42-44 x 11-13 mm
141024	40/45 x 12 mm
140789	42/45 x 12 mm
140790	42/45 x 9 mm
140612 A	43/46 x 13.2 mm, Cargo 140443 (319)
140611 A	46/49 x 13.2 mm, Cargo 140239 (336)
140791	47/49 x 12 mm
141035	47/49-51 x 12.5-15 mm
140610 A	47/50 x 18 mm, Cargo 140411 (B 15-84)

Standard Needle Bearings Cross Reference List

TYPE	CARGO	Pkg
HK 0408	141168 A	4/8 x 7.9 mm..... 10
HK 0509	140617 A	5/9 x 9 mm..... 5
HK 0608	140620 A	6/10 x 8 mm..... 5
HK 0609	140619 A	6/10 x 9 mm..... 5
HK 0808	140751 A	8/12 x 8 mm..... 5
HK 0810	140468 A	8/12 x 10 mm..... 5
HK 0908	141247	9/13 x 8 mm..... 10
HK 0910	140935 A	9/13 x 10 mm..... 5
HK 1010	140482	10/14 x 10 mm..... 5
NK 1012	140903 A	10/17 x 12 mm..... 5
HK 1012RS	141001 A	10/14 x 12 mm..... 5
HK 1210	140242 A	12/16 x 10 mm..... 10
HK 1212	140494 A	12/18 x 12 mm..... 10
HK 1214RS	140483	12/18 x 14 mm..... 5
HK 1214 2RS FPMD	141054 A	12/18 x 14 mm..... 5
HK 1216 2RS	140904 A	12/18 x 16 mm..... 5
HK 1412	140503 A	14/20 x 12 mm..... 5
HK 1512	140495 A	15/21 x 12 mm..... 5
HK 1514RS	141039 A	15/21 x 14 mm..... 10
HK 1812	140375 A	18/24 x 12 mm..... 5
HK 1814RS	140759	18/24 x 14 mm..... 5
HK 1816	140197 A	18/24 x 16 mm..... 5
HK 1816 2RS	140902	18/24 x 16 mm..... 5
HK 2012	140457 A	20/26 x 12 mm..... 5
HK 2212	140381 A	22/28 x 12 mm..... 1
HK 2216 2RS	140972	22/24 x 16 mm..... 5
HK 2220	140733	22/28 x 20 mm..... 5
HK 2220 2RS	140901	22/28 x 20 mm..... 5
HK 3016	141040	30/37 x 16 mm..... 5

Needle Bearings

BOSCH



140197 Std pkg 5 **A**
Replacing 2000 910 002, HK-1816
Servicing 0001 410 . . . , 0001 411 . . . ,
 0001 416 . . .
 18/24 x 16 mm



140198 Std pkg 10 **A**
Replacing 2000 910 005
 34/48 x 15 mm



140242 Std pkg 10 **A**
Replacing 9001 140 384
Servicing Gear reduction starter
 12/16 x 10 mm



140482 Std pkg 5 **A**
Replacing HK 1010
Servicing E95R
 Gear reduction starters
 10/14 x 10 mm



140617 Std pkg 5 **A**
Replacing HK-0509
 5/9 x 9 mm (Gear)



140620 Std pkg 5 **A**
Replacing HK-0608
 6/10 x 8 mm (Gear)



140717 Std pkg 5
Replacing 2000 910 004
Servicing 0001 510 . . .
 19.05/25.4 x 15.88 mm



140733 Std pkg 5
Replacing HK 2220
Servicing 0001 420 . . .
 22/28 x 20 mm



140807 Std pkg 10 **A**
Replacing 1000 917 004
 10/14 x 14 mm
 Closed end



140903 Std pkg 5 **A**
Replacing 9003 330 901
 10/17 x 12 mm



140904 Std pkg 5 **A**
Replacing 9003 330 903
 12/18 x 16 mm



140935 Std pkg 5 **A**
Replacing 1000 917 006
 9/13 x 10 mm

Needle Bearings

140971 Std pkg 5
Replacing 2000 910 013
 15.88/23.88 x 21.88 mm
 Closed end



141054 Std pkg 5 **A**
Replacing 1000 917 000
 12/16 x 14 mm

142019

Replacing HK 2512
Servicing 0001 241 003, -007, -014
 25/32 x 12 mm



140972 Std pkg 5
Replacing 2000 910 012
 22/28 x 16 mm



141084 Std pkg 5
Replacing 1000 917 007
Servicing 0001 121 022, -023,
 0001 124 020, -021, 0001 125 016, -017
 30.5/37 x 15.9 mm



141007 Std pkg 5
Replacing 2000 910 015
Servicing 0001 372 001, -002, -003, -004
 16/23.85 x 18.95 mm
 Double sealed

141256

Replacing F-231294
Servicing 0001 107 404, -405, -429, -435,
 0001 108 400, -405, -406, 0001 120 402,
 -403, -406, -407, 0001 121 402, -403, -408



141015 Std pkg 5
Replacing 2000 910 011
 15.88/20.64 x 19.05 mm



142001
Replacing 1000 917 009, F-235208
Servicing 0001 120 400, -401, -402, -403,
 -404, -405, -406, -407, -408, -409, -410
 28.1/35.2 x 14.6 mm



Needle Bearings

CAV



141039 Std pkg 10 **A**
Replacing HK 1514RS
Servicing S115HD...
 15/21 x 14 mm



141040 Std pkg 5
Replacing HK 3016
Servicing S115HD...
 30/37 x 16 mm
 D.E. Bracket



141041 Std pkg 5
Replacing F-203978
Servicing S115HD...
 22.65/28 x 15.86 mm
 I.M. Bracket

CHRYSLER



140240 Std pkg 10 **A**
 17/23.8 x 17.4 mm



140241 Std pkg 10
Replacing 1975322, 3874074
 17/23.8 x 20.6 mm
 Closed end

DELCO Eur.



140115 Std pkg 10 **A**
Replacing 3472455
 11.0/17.5 x 16.5 mm
 Closed end



140242 Std pkg 10 **A**
Servicing PMGR series
 Gear reduction starter
 12/16 x 10 mm



140468 Std pkg 5 **A**
Servicing PMGR series
 8/12 x 10 mm
 Gear shaft



140470 Std pkg 5 **A**
Servicing PMGR series
 25.4/31.75 x 9.53 mm
 Stationary gear

Needle Bearings

140750 Std pkg 5
Servicing 9000751, -758
 22.2/28.6 x 9.4 mm
 Stationary gear



140751 Std pkg 5 **A**
Replacing HK 0808
Servicing 9000751, -756, -758
 8/12 x 8 mm
 Drive shaft



140752 Std pkg 5 **A**
Servicing PG 200, -250, PMGR
 9.5/14.3 x 7.9 mm
 Drive shaft

DELCO KOR.

141247 Std pkg 10
Replacing HK0908
 9/13 x 8 mm
 Bearing IM

DELCO US

140120 Std pkg 10 **A**
Replacing 9436831, D2OZ-10A304A
Servicing 10 SI, 12 SI, 15 SI, 17 SI, 27 SI
 17/23.8 x 17.4 mm
 Closed end



140136
Replacing 7451782, 9437171
Servicing 20Si, 27Si, Type 200, 29Si, 40Si
 17/23.8 x 32 mm
 Closed end



140228
Replacing 9436064
Servicing 25 SI, 27 SI, 30 SI
 22.2/30.2 x 20.5 mm
 Outer race roller



140229
Replacing 9436063
Servicing 25 SI, 27 SI, 30 SI
 17/22.2 x 25.4 mm
 Inner race

Needle Bearings



140240 Std pkg 10 **A**
Replacing 9433301, 9437211, 9437222
Servicing 10 DN Series
 17/23.8 x 17.4 mm



140470 Std pkg 5 **A**
Replacing 9440922
Servicing PMGR series
 25.4/31.75 x 9.53 mm
 Gear housing



140771 Std pkg 5
Replacing 1974862
Servicing 10 SI/116, 10 SI/136
 17/23.8 x 19.6 mm
 Heavy duty, double seal, closed end



140241 Std pkg 10
Replacing 1975322, 3874074
Servicing 15 SI
 17/23.8 x 20.6 mm
 Closed end



140750 Std pkg 5
Servicing 9000700, -756
 22.2/28.6 x 9.4 mm



140772 Std pkg 5
Replacing 9439542, 10472936
Servicing 15 SI/116, 21 SI
 17/23.8 x 22 mm
 W/ double seal, closed end



140242 Std pkg 10 **A**
Replacing 9440923
Servicing PMGR series
 12/16 x 10 mm



140751 Std pkg 5 **A**
Replacing HK 0808
Servicing 9000751, -756, -758
 8/12 x 8 mm



140773 Std pkg 5
Replacing 10470411, 10474368
Servicing CS 144
 17/23.8 x 17 mm
 Closed end



140421 **A**
Replacing 9441607
Servicing 5 MT
 11.13/15.9 x 12.7 mm



140752 Std pkg 5 **A**
Replacing 9440920
Servicing PG 200, -250. PMGR
 9.5/14.3 x 7.9 mm
 Drive shaft

Needle Bearings
FORD US

140120 Std pkg 10 **A**
Replacing 9436831, D2OZ-10A304A
Servicing D2TZ-, D3VY-, D5AZ-
 17/23.8 x 17.4 mm



140242 Std pkg 10 **A**
Replacing C6VY-11135A
Servicing Gear reduction starter
 12/16 x 10 mm



140552 **A**
Replacing E4FZ-11052A, MC-430
Servicing C.E. and gear housing
 15.9/20.65 x 12.7 mm



140620 Std pkg 5 **A**
Replacing HK-0608
Servicing PMGR
 6/10 x 8 mm
 (0.236" / 0.394" x 0.315")



140920 Std pkg 5
Replacing BA 116, SCE 116
 17.46/22.23 x 9.40 mm



141209 **A**
Replacing SCE98
Servicing 1S7U-11000-BA, -BB,
 YC1U-11000-AB, -AE
 14.14/19.05 x 12.65 mm

HITACHI

140381 **A**
Replacing HK2212
 22/28 x 12 mm



140457 Std pkg 5 **A**
Replacing HK 2012
 20/26 x 12 mm



140495 Std pkg 5 **A**
Replacing 2250-1451, HK1512
 15/21 x 12 mm

Needle Bearings

LEECE NEVILLE



140241 Std pkg 10
 Replacing 78625
 Servicing 2300, 2800JB series
 17/23.8 x 20.6 mm
 Closed end

LUCAS



140120 Std pkg 10 **A**
 Replacing 9436831, D2OZ-10A304A
 Servicing A127
 17/23.8 x 17.4 mm

MAGNETI MARELLI



140482 Std pkg 5 **A**
 Replacing HK 1010
 Servicing E95R
 Gear reduction starters
 10/14 x 10 mm



140240 Std pkg 10 **A**
 Servicing A127 w/ vacuum pump
 17/23.8 x 17.4 mm
 Open



140483 Std pkg 5 **A**
 Replacing HK 1214RS
 Servicing E95R
 12/18 x 14 mm



140242 Std pkg 10 **A**
 Replacing HK1210
 Servicing M78, M79
 12/16 x 10 mm



141219 **A**
 Replacing UMB110
 Harley Davidson
 12.7/17.5 x 14.2 mm
 Closed end

Needle Bearings
MITSUBA

140457 Std pkg 5 **A**
Servicing PMGR
 20/26 x 12 mm
 Stationary gear



140468 Std pkg 5 **A**
Servicing PMGR
 8/12 x 10 mm
 Gear shaft



140768 Std pkg 5
Servicing PMGR
 12.5/17 x 17 mm

MITSUBISHI

140514 **A**
Replacing S933P65270
Servicing Mitsubishi
 12/17 x 12 mm



140738 Std pkg 10 **A**
Replacing S933P70605
Servicing M1T76381, -74781A, -90081A,
 -90081A, M2T225082, -25083, -25281
 10/15 x 15 mm



140876 Stg pkg 5 **A**
Replacing TLA141912ZE01
Servicing M2T56471, -56472, -65271
 14/18.73 x 12 mm
 I.M. Bracket



140920 Std pkg 5
Replacing BA116 Z
Servicing PMGR
 17.46/22.23 x 9.40 mm



141065
Servicing M8T50071, -50171, -70071
 20.5/27.0 x 9.5 mm



141090 Std pkg 10 **A**
Replacing D501005C
 10 x 15/12.5 x 15.4 mm
 Closed end

Needle Bearings

NIPPONDENSO



140767 Std pkg 5 **A**
Replacing KOYO 11MFNM 1515 NM
Servicing 128000-2800, -4130, -4170, -4430, -4450, -4531, -5010, -5150, -5980, 11.0/15.5 x 14.3 mm



140768 Std pkg 5 **A**
Replacing KOYO 13MFNM 1717TCU,
Servicing 128000-1683, -2421, -2430, -2540, -2941, -3641, -4880, -5120, -5520, 12.5/17 x 17 mm



141086
 17//24 x 20 mm
 Closed end

PARIS RHONE/VALEO



140375 Std pkg 5 **A**
Servicing D9R . . .
 18/24 x 12 mm



140919 Std pkg 5 **A**
Replacing 186448
 10/14 x 14 mm
 Closed end



141001 Std pkg 5 **A**
Servicing D7R...
 10/14 x 12 mm



141168 Std pkg 10 **A**
 4/8 x 7.9 mm



141225
Replacing F123459.2 Ina
Servicing D7RS29, -30, -31, -50, -130, -131, -150
 XX/36.7 x 13.3 mm



142003 
Servicing D7ES5
 26.1/33 x 13.7 mm

Needle Bearings**SAWAFUJI****140136**

Replacing 6206-002-00x0
17/23.8 x 31.5 mm
Closed end

Roller Bearings

BOSCH



140515 A

Replacing 1900 910 024, NU 202 ECP
15/35 x 11 mm



140516 Std pkg 10 **A**

Replacing 1900 910 032, NU 205 ECP
25/52 x 15 mm



140649

Replacing 1900 900 206, 16009
Servicing 0001 510 . . .
45/75 x 10 mm



140650

Replacing 2000 914 012, NU 305
Servicing 0001 510 . . .
25/62 x 17 mm



140816 Std pkg 10

Replacing 2120 910 000, NU 204
20/47 x 14 mm

CAV



140445 Std pkg 5

Replacing 6019-670, CRL10A
Servicing AC7
31.75/69.85 x 17.462 mm
(1.25"/ 2.75" x 0.6875")

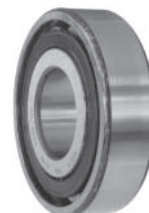

140446 Std pkg 5

Replacing 6270-315, N306ECP
Servicing AC203
30/72 x 19 mm



141044 Std pkg 5

Replacing 6500-173, NU306E.TVP2
Servicing AC203RA...
30/72 x 19 mm

Roller Bearings
DELCO US

141087

Replacing 7451642, 12333738
 Servicing 20DN, 25Si
 22/40 x 11.9 mm
 Used w/ Inner race: Cargo 141088

141088

Replacing 12333739
 Servicing 20DN, 25Si
 17/22.1 x 17.5 mm
 Inner race
 Used w/ Roller bearing: Cargo 141087

141111

Servicing 15Si, 17Si, CS144
 10/17 x 15 mm
 Inner race

LEECE NEVILLE

141087

Replacing 79406
 Servicing 3425J, 4425J
 22/40 x 11.9 mm
 Used w/ Inner race: Cargo 141089

141089

Replacing 79424
 Servicing 3425J, 4425J
 17/22.1 x 36.5 mm
 Inner race
 Used w/ Roller bearing: Cargo 141087

MISCELLANEOUS

140760

Replacing 30203J
 17/40 x 12 mm

140761

Replacing 30205J
 25/52 x 15 mm

140762

Replacing 30206J
 30/62 x 16 mm

140763

Replacing 30207J
 35/72 x 17 mm

Roller Bearings



140764
 Replacing 30208J
 40/80 x 18 mm

MOTOROLA US



140490
 Replacing 111-73
 Servicing 8LHC 2004Z, -2010Z
 27/47 x 14 mm
 Used w/ Inner race: Cargo 141019

PRESTOLITE



140230
 Replacing 90-2058
 Servicing ANB series
 Outer race 19.05/31.75 x 19.05 mm
 Inner race 12.7/19.05 x 25.4 mm



140803
 Replacing 30204J
 40/47 x 15.3 mm



141019
 Replacing 111-74
 20/27 x 37 mm
 Inner race
 Used w/ Roller bearing: Cargo 140490



140968
 Replacing 30209J
 45/85 x 20.8 mm



140969
 Replacing 30210J
 50/90 x 21.8 mm

Bearing survey (mm)
Special Bearings

Size	CARGO
5 x 16 x 5	FAG 140458
5 x 16 x 5	FAG 140459
6 x 19 x 6	FAG 140299
6 x 19 x 6	FAG 140523
7 x 19 x 6	FAG 140296
7 x 22 x 7	FAG 140300
8 x 22 x 7	FAG 140222
8 x 22 x 7	KBC B140222P
8 x 22 x 7	FAG 140297
8 x 22 x 11 140231
8 x 23 x 11 140232
8 x 23 x 14 140234
8 x 23 x 14 140419
8 x 24 x 8 140848
8 x 28 x 9 140960
9 x 24 x 7	FAG 140298
9 x 26 x 8	FAG 140301
9 x 26 x 8	FAG 140893
10 x 23 x 11 140233
10 x 26 x 8	FAG 140076
10 x 26 x 8	KBC B140076P
10 x 26 x 8	CARGO B140076Z
10 x 26 x 8	FAG 140271
10 x 26 x 8	KBC B140271P
10 x 26 x 8	CARGO B140271Z
10 x 26 x 8 141002
10 x 26 x 10 140784
10 x 27 x 11 140235
10 x 27 x 11 141026
10 x 27 x 11 141103
10 x 27 x 14 140588
10 x 30 x 9	FAG 140079
10 x 30 x 9	KBC B140079P
10 x 30 x 9	CARGO B140079Z
10 x 30 x 9	FAG 140080
10 x 30 x 9	KBC B140080P
10 x 30 x 9	CARGO B140080Z
10 x 35 x 11	FAG 140635
10 x 35 x 11	KBC B140635P
10 x 35 x 11	CARGO B140635Z
12 x 28 x 8	FAG 140077
12 x 28 x 8	KBC B140077P
12 x 28 x 8	CARGO B140077Z
12 x 28 x 8	FAG 140078
12 x 28 x 8	KBC B140078P
12 x 28 x 8	CARGO B140078Z
12 x 28 x 12	FAG 140116
12 x 32 x 10	FAG 140081
12 x 32 x 10	KBC B140081P
12 x 32 x 10	CARGO B140081Z
12 x 32 x 10	FAG 140082
12 x 32 x 10	KBC B140082P
12 x 32 x 10	CARGO B140082Z
12 x 32 x 10 140417
12 x 32 x 13 140989
12 x 32 x 14 140105
12 x 35 x 18 140236
12 x 37 x 12	FAG 140277
12 x 37 x 12	KBC B140277P
12 x 37 x 12	CARGO B140277Z
12.70 x 28.58 x 7.94 140106
15 x 28 x 7 140224
15 x 30 x 14 140265
15 x 32 x 9	FAG 140272
15 x 32 x 9	KBC B140272P
15 x 32 x 9	CARGO B140272Z
15 x 32 x 9	FAG 140284
15 x 32 x 9	KBC B140284P

Size	CARGO
15 x 32 x 9	CARGO B140284Z
15 x 32 x 11 140441
15 x 35 x 11	FAG 140084
15 x 35 x 11	KBC B140084P
15 x 35 x 11	CARGO B140084Z
15 x 35 x 11	FAG 140086
15 x 35 x 11	KBC B140086P
15 x 35 x 11	CARGO B140086Z
15 x 35 x 11 140432
15 x 35 x 11 141012
15 x 35 x 13 140237
15 x 35 x 13 140434
15 x 35 x 14	FAG 140265
15 x 36 x 18 140630
15 x 38 x 19 140461
15 x 40 x 12 140839
15 x 42 x 13	FAG 140091
15 x 42 x 13	KBC B140091P
15 x 42 x 13	CARGO B140091Z
15 x 42 x 13	FAG 140092
15 x 42 x 13	KBC B140092P
15 x 42 x 13	CARGO B140092Z
15 x 42 x 13 141062
15 x 42 x 13 141236
15 x 42 x 17	FAG 140936
15 x 43 x 13 140443
15 x 43 x 24 141018
15 x 46 x 14 140239
15 x 47 x 14 140420
15 x 47 x 18 140411
15 x 52 x 16 140462
15.88 x 20.64 x 19.05 141015
16.96 x 34.97 x 9.94	SKF 141071
17 x 30 x 7 140225
17 x 35 x 10	FAG 140273
17 x 35 x 10	KBC B140273P
17 x 35 x 10	CARGO B140273Z
17 x 35 x 10	FAG 140285
17 x 35 x 10	KBC B140285P
17 x 35 x 10	CARGO B140285Z
17 x 40 x 12	FAG 140087
17 x 40 x 12	KBC B140087P
17 x 40 x 12	CARGO B140087Z
17 x 40 x 12	FAG 140088
17 x 40 x 12	KBC B140088P
17 x 40 x 12	CARGO B140088Z
17 x 40 x 12 141107
17 x 40 x 16	FAG 140900
17 x 40 x 17.5 141110
17 x 47 x 14	FAG 140093
17 x 47 x 14	KBC B140093P
17 x 47 x 14	CARGO B140093Z
17 x 47 x 14	FAG 140094
17 x 47 x 14	KBC B140094P
17 x 47 x 14	CARGO B140094Z
17 x 47 x 14 141233
17 x 47 x 18 140589
17 x 47 x 19	FAG 140266
17 x 47 x 24 140783
17 x 52 x 16 140460
17 x 52 x 17 140263
17 x 52 x 17 141232
17 x 52 x 18 140754
17 x 52 x 21 140569
17 x 62 x 17	FAG 140394
17 x 62 x 17	FAG 140401
17 x 62 x 17	FAG 140878
17 x 62 x 17.5 140176

Size	CARGO
17 x 62 x 20 140957
19 x 37 x 9 140412
20 x 37 x 9 140226
20 x 42 x 12 141038
20 x 42 x 12	FAG 140223
20 x 42 x 12	KBC B140223P
20 x 42 x 12	CARGO B140223Z
20 x 42 x 12	FAG 140286
20 x 42 x 12	KBC B140286P
20 x 42 x 12	CARGO B140286Z
20 x 47 x 14	FAG 140159
20 x 47 x 14	KBC B140159P
20 x 47 x 14	CARGO B140159Z
20 x 47 x 14	FAG 140218
20 x 47 x 14	KBC B140218P
20 x 47 x 14	CARGO B140218Z
20 x 47 x 14	FAG 140816
20 x 47 x 14 141254
20 x 47 x 14 141255
20 x 52 x 15	FAG 140175
20 x 52 x 15	KBC B140175P
20 x 52 x 15	CARGO B140175Z
20 x 52 x 15	FAG 140278
20 x 52 x 15	KBC B140278P
20 x 52 x 15	CARGO B140278Z
20 x 52 x 21	FAG 140442
22 x 56 x 21 140917
25 x 42 x 9 140227
25 x 47 x 12	FAG 140274
25 x 47 x 12	KBC B140274P
25 x 47 x 12	FAG 140287
25 x 47 x 12	KBC B140287P
25 x 52 x 15	FAG 140089
25 x 52 x 15	KBC B140089P
25 x 52 x 15	CARGO B140089Z
25 x 52 x 15	FAG 140219
25 x 52 x 15	KBC B140219P
25 x 52 x 15	CARGO B140219Z
25 x 52 x 15	FAG 140516
25 x 52 x 20.6 140882
25 x 62 x 17 080587
25 x 62 x 17	FAG 140279
25 x 62 x 17	KBC B140279P
25 x 62 x 17	CARGO B140279Z
25 x 62 x 17	FAG 140292
25 x 62 x 17	KBC B140292P
25 x 62 x 17	CARGO B140292Z
25 x 62 x 24	FAG 140879
25 x 62 x 25.4 140883
28 x 58 x 16 142021
30 x 47 x 9 140868
30 x 47 x 9 141166
30 x 55 x 13	FAG 140283
30 x 55 x 13	KBC B140283P
30 x 55 x 13	FAG 140886
30 x 55 x 13	KBC B140886P
30 x 62 x 14	FAG 140887
30 x 62 x 14	KBC B140887P
30 x 62 x 16	FAG 140220
30 x 62 x 16	KBC B140220P
30 x 62 x 16	CARGO B140220Z
30 x 62 x 16	FAG 140288
30 x 62 x 16	KBC B140288P
30 x 62 x 16	CARGO B140288Z
30 x 72 x 19	FAG 140280
30 x 72 x 19	KBC B140280P
30 x 72 x 19	FAG 140293
30 x 72 x 19	KBC B140293P

Bearing survey (mm)

Special Bearings - continued

Size	CARGO
30 x 72 x 19	KBC ... B140446P
30 x 72 x 27	140707
30 x 72 x 30.2	140884
35 x 62 x 14	FAG 140631
35 x 62 x 14	KBC ... B140631P
35 x 72 x 17	FAG 140275
35 x 72 x 17	KBC ... B140275P
35 x 72 x 17	FAG 140289
35 x 72 x 17	KBC ... B140289P
35 x 80 x 21	FAG 140281
35 x 80 x 21	KBC ... B140281P
35 x 80 x 21	FAG 140294
35 x 80 x 21	KBC ... B140294P
37 x 25 x 7	142005
40 x 68 x 15	FAG 140632
40 x 68 x 15	KBC ... B140632P
40 x 68 x 15	FAG 140888
40 x 68 x 15	KBC ... B140888P
40 x 80 x 18	FAG 140276
40 x 80 x 18	KBC ... B140276P
40 x 80 x 18	FAG 140290
40 x 80 x 18	KBC ... B140290P
40 x 90 x 23	FAG 140282
40 x 90 x 23	KBC ... B140282P
40 x 90 x 23	FAG 140295
40 x 90 x 23	KBC ... B140295P
45 x 75 x 10	FAG 140649
45 x 75 x 16	FAG 140633
45 x 75 x 16	KBC ... B140633P
45 x 75 x 16	FAG 140889
45 x 75 x 16	KBC ... B140889P
45 x 85 x 19	FAG 140636
45 x 85 x 19	KBC ... B140636P
45 x 100 x 25	FAG 140302
45 x 100 x 25	KBC ... B140302P
50 x 80 x 16	FAG 140634
50 x 80 x 16	KBC ... B140634P
50 x 80 x 16	KBC ... B140890P
50 x 90 x 20	FAG 140637
50 x 90 x 20	KBC ... B140637P
50 x 110 x 27	FAG 140303
50 x 110 x 27	KBC ... B140303P
50 x 110 x 27	KBC ... B140894P
55 x 90 x 18	FAG 140891
55 x 90 x 18	KBC ... B140891P
55 x 90 x 18	KBC ... B140892P
55 x 100 x 21	FAG 140638
55 x 100 x 21	KBC ... B140638P
55 x 120 x 29	FAG 140304
55 x 120 x 29	KBC ... B140304P
60 x 110 x 22	FAG 140291
60 x 110 x 22	KBC ... B140291P
60 x 130 x 31	FAG 140641
60 x 130 x 31	KBC ... B140641P
65 x 120 x 23	FAG 140639
65 x 140 x 33	FAG 140642
65 x 140 x 33	KBC ... B140642P
70 x 125 x 24	FAG 140640
70 x 125 x 24	KBC ... B140640P
70 x 150 x 35	FAG 140643
70 x 150 x 35	KBC ... B140643P

Needle Bearings

Size	CARGO
4 x 8 x 7.9	141168
5 x 9 x 9	140617
6 x 10 x 8	140620
6 x 10 x 9	140619
8 x 12 x 8	140751
8 x 12 x 10	140468
9 x 13 x 8	141247
9 x 13 x 10	140935
9.5 x 14.3 x 7.9	140752
10 x 14 x 10	140482
10 x 14 x 12	141001
10 x 14 x 14 *	140807
10 x 14 x 14 *	140919
10 x 15 x 15	140738
10 x 15/12.5 x 15.4 *	141090
10 x 17 x 12	140903
11 x 15.5 x 14.3	140767
11 x 17.5 x 16.5 *	140115
11.13 x 15.9 x 12.7	140421
12 x 14 x 16	141054
12 x 16 x 10	140242
12 x 17 x 12	140514
12 x 18 x 12	FAG 140494
12 x 18 x 14	140483
12 x 18 x 16	140904
12.5 x 17 x 17	140768
12.7 x 17.5 x 14.2 *	141219
14 x 18.73 x 12	140876
14 x 20 x 12	140503
14.14 x 19.05 x 12.65	141209
15 x 21 x 12	140495
15 x 21 x 14	141039
15.88 x 23.88 x 21.88 *	140971
15.9 x 20.65 x 12.7	140552
16 x 23.85 x 18.95	141007
17 x 22.2 x 25.4	140229
17 x 23.8 x 17 *	140773
17 x 23.8 x 17.4 *	140120
17 x 23.8 x 17.4	140240
17 x 23.8 x 19.6	140771
17 x 23.8 x 20.6 *	140241
17 x 23.8 x 22	140772
17 x 23.8 x 32 *	140136
17 x 24 x 20 *	141086
17.46 x 22.23 x 9.40	140920
18 x 24 x 12	140375
18 x 24 x 14	FAG 140759
18 x 24 x 16	140197
18 x 24 x 16	140902
19.05 x 25.4 x 15.88	140717
19.1 x 41.3 x 11.1	141108
20 x 26 x 12	140457
20.5 x 27 x 9.5	141065
22 x 28 x 12	140381
22 x 28 x 16	140972
22 x 28 x 20	140733
22 x 28 x 20	140901
22.2 x 28.6 x 9.4	140750
22.2 x 30.2 x 20.5	140228
22.65 x 28 x 15.86	141041
25 x 32 x 12	142019
25.4 x 31.75 x 9.53	140470
26.1 x 33 x 13.7	142003
28.1 x 35.2 x 14.6	142001
30 x 37 x 16	141040
30.5 x 37 x 15.9	141084
34 x 48 x 15	140198

* Closed ends

Roller Bearings

Size	CARGO
15 x 35 x 11	140515
17 x 40 x 12	140760
20 x 47 x 14	140816
22 x 40 x 11.9	141087
25 x 52 x 15	140516
25 x 52 x 15	140761
25 x 62 x 17	140650
27 x 47 x 14	140490
30 x 62 x 16	140762
30 x 72 x 19	140446
30 x 72 x 19	FAG 141044
31.75 x 69.85 x 17.462	140445
35 x 72 x 17	140763
40 x 47 x 15.3	140803
40 x 80 x 18	140764
45 x 75 x 10	140649
45 x 85 x 20.8	140968
50 x 90 x 21.8	140969

Various
MULTI-PURPOSE GREASE

200745 200 gr. tupe

LGMT 2/0.2.

Multi-purpose grease for general and industrial use. Specially suitable for small and medium-sized bearings, even under demanding conditions. Cargo 200745 offers excellent water repellent properties and good protection against corrosion.

Typical applications include agricultural machinery, motor vehicle wheel bearings, small electric motors, conveyor systems, etc.

BEARING GREASE

Molykote BR 2 plus universal heavy duty grease provides:

- reduction of wear
- emergency lubrication
- higher operational reliability
- extended lubrication intervals even under high loads and difficult running conditions. Molykote BR 2 plus is suitable for a wide temperature range; it is resistant to oxidation and resists hot and cold water. It also has good corrosion-inhibiting properties.

Range of application

Molykote BR 2 plus can be used wherever grease lubrication is normally applied, e.g. for:

- all types of antifriction bearings
- plain bearings and guides
- joints and splined shafts
- threaded spindles and small gear units at low speeds and all bearings subject to severe impact loads or exposed to extreme atmospheric conditions
- for chassis lubrication on motor vehicles.

200746

100 gr. tube.

200747

 1 kg can.



Molykote 33 are used to lubricate ball and sometimes roller bearings operating under light to moderate loads and at low to medium speeds.

Typical applications include:

- Starter drives
- Freezer car casters, and cold room conveyor equipment.
- Maximum-demand meters, power-factor meters, watt-hour meters.
- Windshield wiper motor gears.

200748

100 gr. tube.

200749

1 kg can.

200750

 25 kg drum.

O-Ring Survey



Size mm	No.	Servicing	Std pkg	Size mm	No.	Servicing	Std pkg
3.8 x 1.7	233054	DR US	10	70 x 2.5	137154	Bo	5
4 x 2	134485 A	DR, Mi, ND	10	71 x 2	132900 A	ND 1.4 kW. Field housing	10
4.7 x 1.7	233053	DR US	10	71 x 3	138193	PR	10
5 x 2	134484 A	ND	10	72 x 2	133598 A	Mi	5
6 x 1.8	139422	ND	10	79 x 1.5	133974	DR US 28 MT, C.E. frame	5
6 x 1.8	233057	DR US	10	80 x 1.5	230147	MI,ND	5
6 x 2	134633 A	DR	10	82.6 x 1.4	231391	Hi	5
6 x 2.5	134692 A		10	83 x 3.0	136690	Bo 0001 420	5
6 x 3	138750		10	84.5 x 2.5	233051	DR US	10
7 x 2.5	139839	Lu	10	87 x 1.5	133965 A	DR US 28 MT, 10456474	5
8 x 1.8	233046	DR US	10	92 x 3	136630	La	5
8 x 2	134486 A	DR, Mi, ND	10	95 x 2	233084	ND	10
8 x 2.5	135498	ND	10	100 x 2	134965 A	MM MT67,71,72	10
9.2 x 1.8	233048	DR US	10	104.5 x 3	134613 A	MM MT68	10
9.58 x 1.78	233599	CA	1	105 x 2	230447	Bo	5
10 x 2	134487 A	DR, Mi, ND	10	105 x 4	136340	Bo	10
11.2 x 1.8	139421	ND	10	105 x 5	238300	Ca	10
12 x 2.5	138751		10	106 x 4.5	136431	PR 055578, Ca 6211-675L	5
12 x 3	134776 A	Bo, PR	10	114.5 x 3.5	233052	DR US	10
13 x 3	137730	PR	10	123 x 3	136691	Bo 0001 420	5
15.5 x 2.6	233047	DR US	10	125 x 2.5	233050	DR US	10
16 x 2.5	134482 A	Mi	10	129 x 1.6	234941	PR	1
19.7 x 1.2	139423	ND	10	160 x 2.5	232433	Bo	5
25 x 2	132660 A	Hi LR225-65, LR235-402	5				
26 x 2	137038	Hi	10				
28 x 2	135357	Bo	10				
30 x 2	139561	Mo	10				
30 x 2.5	139562	Is	10				
31.34 x 3.53	137736	Lu	5				
32 x 2	138007	Bo	5				
32 x 4	135399	Lu	10				
34 x 1.7	139737	Ca	5				
34.65 x 1.75	233712	Is	10				
35 x 2	134612 A	Bo	10				
38 x 2.5	136681	MT 443 115 144 702, -722, -742	5				
39.3 x 2.6	232454	Ch Brush boxes	5				
40 x 1	134491 A	Du Drives	10				
40 x 2	134488 A	PR Drives	10				
40 x 2.5	230634	Bo	10				
42 x 2	233985		10				
43 x 2	134489 A	Hi, MT	10				
43 x 2.5	132893 A	ND 1.0, 1.4 kW. D.E. housing	10				
47.29 x 2.62	134716 A	Is	10				
48 x 2.5	132891 A	ND 2.5 kW. D.E. housing	10				
49.2 x 3	231331	PR	10				
50 x 1.8	237684	Poo	10				
52 x 3	134931 A		10				
53 x 2	232432		10				
56 x 2	133040 A	ND					
		Alternators w/ vacuum pump, S.R.E.	10				
56.7 x 3.5	233049	DR US	10				
61 x 2	132659 A	Hi LR225-65, LR235-402	5				
62 x 2	134490 A	Hi	10				
63.5 x 1.58	133717 A	ND 028000-8411, -8422, -9133	5				
64 x 2.5	133597 A	ND	5				
69 x 2	132892 A	ND 1.4 kW.	10				
		w/ cast aluminium C.E. frame, field housing					
70 x 1.5	138433		10				
70 x 2	137717	Lu	10				

Washer Survey

Sealing Rings



DIN 7603

Std pkg 100

	I.D.	O.D.	Thick	
080006	5.0	8.0	1.0	Copper
190823 A	6.0	10.0	1.0	Copper
190824	6.0	12.0	1.0	Copper
190826 A	8.0	12.0	1.0	Copper
080007	8.0	12.0	1.5	Copper
190828 A	8.0	14.0	1.0	Copper
080008	10.0	12.0	1.5	Copper
190805 A	10.0	14.0	1.0	Copper
190806 A	10.0	16.0	1.0	Copper
080009	10.2	13.5	1.0	Copper
190807 A	12.0	16.0	1.5	Aluminium
190808 A	12.0	16.0	1.5	Copper
190809 A	12.0	18.0	1.5	Copper
191358 A	12.0	24.0	1.0	Copper
190810 A	13.0	18.0	1.5	Copper
190811 A	14.0	18.0	1.5	Aluminium
190812 A	14.0	18.0	1.5	Copper
190813 A	14.0	20.0	1.5	Aluminium
190815 A	14.0	20.0	1.5	Copper
080010	15.0	18.0	1.5	Copper
080011	15.0	18.0	1.5	Copper
190816 A	16.0	19.5	1.0	Copper
190817 A	16.0	20.0	1.5	Copper
190818 A	16.0	22.0	1.5	Copper
191489 A	16.0	24.5	1.5	Copper
080016	18.0	21.5	0.5	Copper
190819 A	18.0	22.0	1.5	Copper
190820 A	18.0	24.0	1.5	Copper
191490	18.0	26.0	1.5	Copper
190821 A	20.0	26.0	1.5	Copper
080012	20.0	24.0	1.5	Copper
080013	21.0	25.0	1.5	Copper
080014	22.0	26.0	1.5	Copper
190822 A	22.0	27.0	1.5	Copper
080015	22.0	28.0	1.5	Copper
080017	25.5	30.0	1.5	Copper

Various Washers

	I.D.	O.D.	Thick	
134766	15.0	41.0	1.0	Rubber
135469	18.0	28.0	4.0	Rubber
134708	29.0	59.2	1.9	Rubber
134709	39.0	58.6	1.9	Rubber
135470	18.0	30.0	4.0	Rubber
134914	14.4	19.7	2.4	Steel
135634	15.4	23.0	2.0	Brake w.
135290	29.7	12.1	2.0	Brake w.



	I.D.	O.D.	Thick
132581 A	5.00/9.00	14.00	4.00
132582 A	6.35/14.73	15.08	6.00

Insulator Paper



191379

Polyuspan
Dim. 61.5 x 80 cm
Thickness 0.30 mm



191443

Red fiber
Dim. 120 x 220 cm
Thickness 0.50 mm

Insulator Washers Fiber



Std pkg 100

	I.D.	O.D.	Thick
191346 A	4.0	13.0	1.0
080031	5.0	9.5	2.0
191341 A	5.0	10.0	1.0
191351 A	5.0	12.0	1.0
191352 A	5.0	16.0	1.0
191344 A	6.0	10.0	1.0
080032	6.0	10.0	1.5
191350 A	6.0	18.0	1.5
191442 A	7.5	14.0	3.0
191353 A	8.0	12.0	0.5
080033	8.0	15.0	1.5
191345 A	8.0	20.0	2.0
191434 A	10.0	14.0	1.0
191349 A	10.0	16.0	1.0
080034	10.0	16.0	1.5
191648	10.0	25.0	2.0
191356 A	10.0	29.0	1.0
080035	12.0	18.0	1.5
191339 A	12.0	19.0	1.0
191348 A	12.0	22.0	1.0
134768	12.0	22.0	2.0
134699	12.3	24.0	1.0
191347 A	13.0	23.0	1.5
191646	13.0	29.0	2.0
080036	14.0	20.0	1.5
191430 A	14.0	29.0	1.0
191532	14.0	34.0	2.0
191343 A	14.0	35.0	0.5
191342 A	15.0	29.0	3.0
191647	15.5	40.0	2.0
191444 A	17.0	31.0	1.0
134764	18.5	23.5	1.6
135522	19.5	33.0	0.5
135523	19.5	33.0	1.5
134770	20.5	25.8	1.6
191355 A	20.5	35.0	1.5
134769	22.3	27.2	4.4
191357 A	23.8	36.0	2.5
191340 A	29.0	33.0	1.5
191354 A	45.0	51.0	1.0

Oil Seal Survey



	I.D.	O.D.	Thick	Std pkg
138369 A	11	28	7.5	5
132663 A	11.5	25.4	4.5	1 set
+	11.5	25.4	5.0	
132734 A	12	24	6	5
133513 A	14	30	7	5
137803 A	14	30	7	1 set
132664 A	14	30.2	4.5	1 set
+	14	30.3	5	
132662 A	14.8	30	5	1
132297 A	15	32	7	5
132661 A	15	32	7.5	5
132549 A	15.5	30.1	7	1
237688	15.80	30	7	1
138914	16.45	21.5	3	1
132319 A	17	27	7	5
133524 A	17	30/37	8	5
235143	17	35	7	1
132682 A	17.46	34.8	6.35	1
132825 A	17.86	31.75	6.35	1
133020	18	35	7	1
135940	18.73	42	7	1
135575 A	19	27	6	1
133523 A	19	32	6	5
135579 A	19	32	7	5
132382 A	19.45	34.81	9.55	1
134481 A	20	30	7	5
136014 A	20	35	7	1
135642 A	13/16"	1 3/8"	1/4"	5
231573	22	32	7	5
136665 A	22	35	7	5
139895	22.23	28.58	3.8	5
139382	22.63	47.5	10	1
135199 A	23.4	35.2	6	1
139381	23.63	37.5	7	1
133065 A	1.852"			1
139588	27	37	7	5
132981	28	35	3.1	5
233545	28	38.2	2.7	10
139618	28.5	44.5	5	5
230673	29.3	39	1.45	5
139383	29.5	40.5	7	1
230335	30	37	4	5
230367	30	37	4	5
136857 A	30	38	2.6	1
235142	30	47	7.3	1
133066	2.059"			1
131448 A	33	45	7	10
139389	33.5	52.6	6	1
135372 A	35	47	7	5
138130 A	35	51	8	1
136016 A	38	52	7	1
139624	40	52.5	6.5	1
138121 A	79	90	8	5